

oai

COLLECTIONS

spazio
wellness spaces.

EMPRESA

SPAZIA es una empresa especializada en el diseño y fabricación de mamparas de baño a medida y puertas correderas. Nace con la premisa de ajustarse a las demandas del mercado con el único objetivo de ofrecer un servicio personalizado que se adapte a los requerimientos específicos de nuestros clientes.

Para ello buscamos la solución más adecuada a cada una de las diversas situaciones que se pueden presentar en nuestros hogares y baños.

PRODUCTO

Las innovadoras técnicas de SPAZIA, son la base del desarrollo de una gama de productos que evoluciona y mejora constantemente; gracias entre otras cosas, al trabajo de un grupo de profesionales, que se preocupan por el diseño, la investigación, la fiabilidad, la funcionalidad, y el servicio especializado. Estos son los puntos cardinales de la estrategia y la acción de SPAZIA, lo que permite que nuestros clientes puedan disfrutar de una amplísima gama de productos con una calidad inmejorable.

CALIDAD

Todos los elementos de nuestros productos cumplen los más altos estándares de calidad en cuanto a especificaciones técnicas y seguridad se refiere.

Los cristales usados cumplen la normativa que certifica la máxima calidad a los requerimientos de ensayos. Asimismo, todos los perfiles y aleaciones poseen tratamientos anticorrosión para lograr la máxima resistencia y durabilidad.

COMPROMISO

En SPAZIA sabemos que el servicio y asesoramiento son la base fundamental para lograr que el producto llegue a su hogar en las mejores condiciones, y sea instalado de una forma apropiada.

Para ello contamos con una red de profesionales que le asesoraran sobre su correcto uso con el fin de que el producto sea más duradero.

SOCIÉTÉ

SPAZIA est une société spécialisée en design et fabrication de parois de douche sur mesure et portes coulissantes.

Elle a pour ambition de s'ajuster aux demandes du marché avec le seul but d'offrir un service personnalisé qui s'adapte aux requêtes de nos clients.

Pour cela on cherche la solution la plus ajustée à chacune

des différentes situations qu'on peut trouver à la maison et dans la salle de bain.

PRODUIT

Les techniques innovatrices de SPAZIA sont la base du développement d'une gamme de produits qui évoluent et s'améliorent en permanence; grâce entre autre au travail d'un groupe de professionnels, qui se préoccupent du design, de la recherche, de la fiabilité, de la fonctionnalité grâce à un service spécialisé. Ceux-ci sont les points cardinaux de la stratégie et l'action de SPAZIA, ce qui permet à nos clients de pouvoir profiter d'une vaste gamme de produits avec une qualité exceptionnelle.

ENGAGEMENT

À SPAZIA nous savons que le service et l'assistance sont

la base fondamentale pour permettre au produit d'arriver chez vous dans les meilleures conditions, et soit installé correctement.

Pour cela nous avons le soutien d'un réseau de professionnels qui vous conseilleront sur le bon usage afin que le produit soit plus durable.

QUALITÉ

Tous les éléments de nos modèles correspondent aux plus

hauts standards de qualité en ce qui concerne les spécificités techniques et de sécurité.

Les verres sont conformes à la réglementation qui certifie la meilleure qualité aux tests requis. De la même manière, tous les profils et alliages possèdent des traitements anticorrosifs pour obtenir la une résistance et une durabilité maximales.

THE COMPANY

SPAZIA is a company specialized in the design and manufacture of custom-made shower enclosures and sliding doors. It was born with the premise to adjust itself to the market demands, with the sole objective of offering a personalized service adapted to the specific requirements of our customers.

To that end we seek the most adequate solution to each of the diverse situations that could arise in our homes and bathrooms.

PRODUCT

The innovative techniques of SPAZIA are the base for the development of a range of products which constantly evolve and improve; amongst others thanks to the work of a group of professionals concerned with design, research, reliability, functionality and specialized service.

These are the cardinal points of the strategy and SPAZIA's action, which allow our customers to enjoy a very large range of products of unsurpassed quality.

ENGAGEMENT COMMITMENT

At SPAZIA we know that service and counselling are the fundamentals to enable the product to arrive at your home in the best conditions and to be assembled in the appropriate manner.

For that purpose we have a network of professionals who give advice on the correct use in order to make it long-lasting.

QUALITY

All the elements of our products comply with the highest quality standards regarding technical specifications and safety.

The glass utilised complies with the norm certifying maximum quality of the testing requirements.

Likewise, all profiles and alloys have anti-corrosion treatment for maximum resistance and durability.

Indice

12	SOLID
20	SIDE
30	MOON
38	STAR
50	WALL
60	SOLID
68	SIDE
76	MOON
84	SUITE
94	PASS
100	DUNE
108	FORUM
118	NEXUS
126	INFINITI
132	ROLLING
138	COMBI
144	STAR
160	HANDI
164	FLEX
180	NOVA
198	OPEN
204	QUADRO
216	NATURE
226	STYLE
228	NEXUS
234	TECHNICAL
236	ROLLING
238	INVISIBLE
242	FRAME
246	CLICK
248	PACK
250	HIDRA
252	CASSONETTO
254	DATOS TÉCNICOS
274	DECORADOS

Tecnología de vanguardia

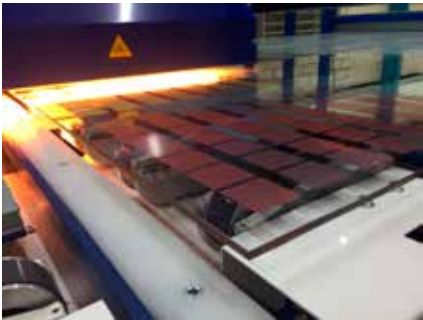

En estos últimos 10 años, Spazia se ha convertido en un referente del mercado de las mamparas, colocándose en los primeros puestos en cuanto a la transformación de vidrio se refiere.

Ha conseguido aunar todos los procesos productivos gracias a la dilatada experiencia en el sector vidriero. Y todo ello, junto con la inversión realizada en la más moderna maquinaria de última generación para la manipulación de vidrio; nos ha convertido en uno de los grupos referentes del sector de la mampara de vidrio, puertas de paso, platos de ducha y herrajes.

Ofertamos la más amplia gama de productos transformados y con la capacidad de combinar distintos procesos como el laminado, templado, curvado, o la impresión con esmaltes vitrificables.

Contamos con más de 15.000 m² de almacenes estratégicamente construidos, en donde se fabrica, manipula, y se empaqueta el producto final en un tiempo récord, acercando nuestros productos a cualquier punto de la península, Baleares o Canarias.



Todos nuestros vidrios cumplen con las más altas exigencias de las normativas europeas aplicables y también con el código Técnico de la Edificación, que mediante el Reglamento Europeo de Productos de Construcción N°305/2011, que obliga al marcaje y a la declaración de las características técnicas de los productos de construcción incorporados con carácter permanente a las obras.

La declaración de prestaciones y el marcado CE obligatorio, permite la fabricación y comercialización de los productos en el ámbito de la Unión Europea y exige una evaluación satisfactoria de los productos de acuerdo con las normas armonizadas correspondientes y el sistema de certificación de la conformidad aplicable. Puede solicitar a Spazia la declaración de prestaciones de los productos que fabrica y comercializa en la página web: www.spazia.net



Control de calidad

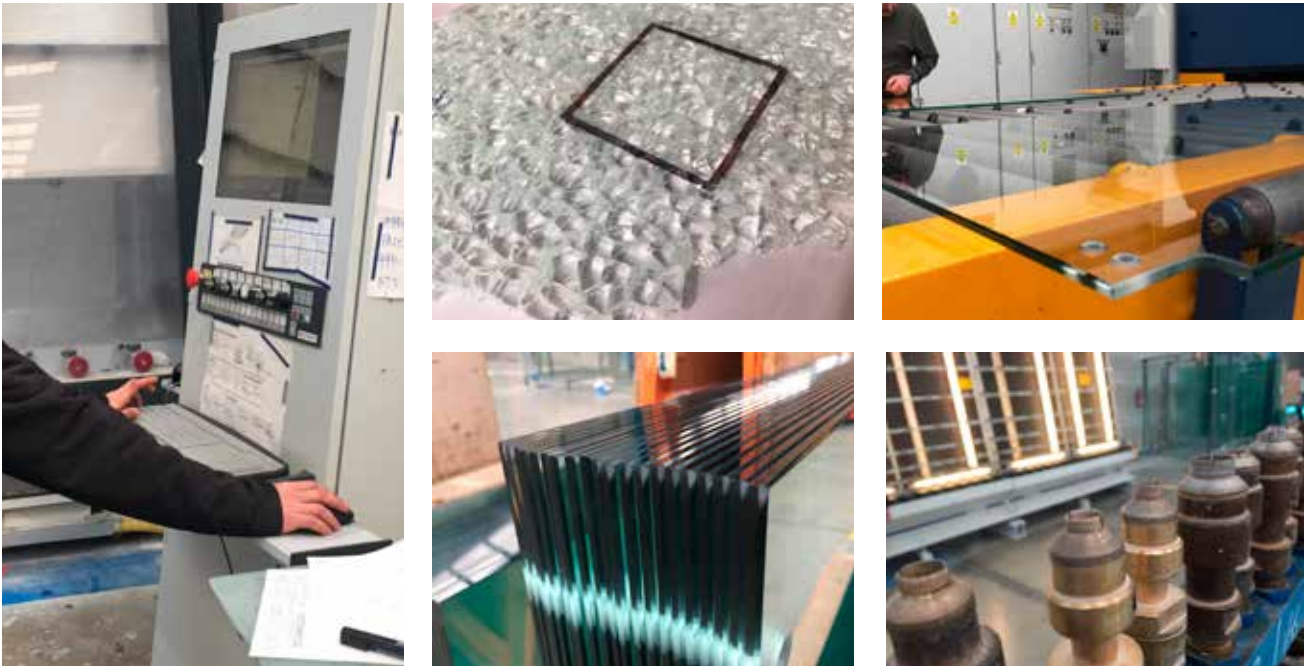

La calidad es mucho más que un simple proceso; es nuestra forma de trabajar en SPAZIA. Es la única manera de satisfacer las expectativas de todos nuestros clientes.

La Calidad ha de verse reflejada tanto en los productos como en el servicio. En SPAZIA somos muy rigurosos en mantener al pie de la letra los cumplimientos de todos los requisitos necesarios para la obtención de las certificaciones y homologaciones de nuestros productos.

Empleamos la máxima calidad en la fabricación de nuestros productos, garantizando su durabilidad y resistencia. Y para ello sometemos a cada uno de nuestras mamparas, a pruebas de fatiga y desgaste para conseguir la validación de todos los modelos en base a la norma internacional EN 14428:2005, norma específica para mamparas de ducha que testea tanto los componentes como el producto final en uso, durabilidad y limpieza a lo largo del tiempo.

Con el cumplimiento de las exigencias de esta norma las mamparas de SPAZIA obtienen el marcado CE, punto clave para satisfacer plenamente los requerimientos de la Comunidad Europea.

Otro punto importante dentro de nuestro circuito de calidad, es la formación del personal de Spazia, que genera una calidad humana, mantenida y compartida por personas que se empeñan en hacer su trabajo cada día mejor.

Porque otro de nuestros grandes secretos es la calidad de las personas que trabajan en SPAZIA. Y con esta gran calidad humana nuestras mamparas de baño se alzan sobradamente sobre cualquier estándar de calidad.

Simbología / symbologie / symbology



Mampara fija
Douche ouverte - paroi fixe
Walk-in screen



Puertas correderas
Portes coulissantes
Sliding doors



Puertas plegables
Portes pliantes
Bi-fold doors



Puertas solapas
Portes pivotantes
Overlaid doors



Puertas batientes
Portes battantes
Hinged doors



Espesor vidrio
Épaisseur du verre
Glass thickness



Tratamiento spazia antical a dos caras
Traitement anticalcaire en option
Anti-limescale treatment in option



Incremento por recorte en el vidrio
Découpe dans le verre
Notch and angle glass cut



Envío inmediato
expédition immédiate
immediate shipment



Opción impresión
Décoration imprimé
Printed Decoration



Altura mampara
Hauteur de la paroi
Shower enclosure height



Expansión del perfil a pared
Réglage des faux aplombs
Up out-of-true walls



Expansión del perfil a pared
Réglage des faux aplombs
Up out-of-true walls



Apertura puerta 180°
Ouverture de porte 180°
180° opening door



Apertura puerta 90°
Ouverture de porte 90°
90° opening door



Ruedas con ajuste vertical
Roulettes avec réglage vertical
Steel roller bearings with vertical adjustment



Cierre magnético
Fermeture des portes face à face avec bande magnétique
Magnetic closing seals in face to face doors



Cierre amortiguado
Fermeture de porte amortissé
Soft closing door



Mampara reversible
Douche réversible
Reversible shower



Apertura a izquierda
Ouverture gauche
Left opening



Apertura a derecha
Ouverture droite
Right opening



Peso máximo puerta
Poids maximum de porte
Maximum door weight



Suplemento del precio mayor de altura
Supplément de prix par augmentation en hauteur
Price grow due to height increasing

Tipos de acabados / Types de finitions / Types of finishes



Perfilería en acabado cromo brillo
Profils chromés brillants
Chrome shine profiles



Perfilería acabado mate
Profils chromés mats
Matt profiles



Perfilería acabado negro mate
Profils chromés mats
Matt black profiles



Perfilería acabado cobre
Profils finis en cuivre
Copper profiles

Spazio

SOLUCIONES ENTRE PAREDES

ESPACIOS LIBRES

		●	●	●													SOLID
	●	●	●														SIDE
	●	●	●														MOON
				●	●	●	●	●				●					STAR
													●			●	WALL
	●	●	●														SOLID
	●	●	●														SIDE
	●	●	●														MOON
●	●	●	●														SUITE
	●																PASS
	●	●	●													●	DUNE
	●	●	●													●	FORUM
	●	●	●													●	NEXUS
	●		●														INFINITI
	●																ROLLING
	●					●											COMBI
				●	●	●	●	●	●	●	●						STAR
				●		●											HANDI
				●	●	●	●	●	●	●	●						FLEX
				●	●	●	●	●	●	●		●					NOVA
					●		●	●	●								OPEN
				●	●	●	●	●				●					QUADRO
													●	●		●	NATURE
●	●	●	●														NEXUS
●	●																TECHNICAL
●	●																STYLE
●	●																ROLLING
●	●	●	●														INVISIBLE
●	●	●	●														FRAME
●																	CASSONETTO
				●													CLICK
				●								●					PACK
				●								●					HIDRA
																	DATOS TÉCNICOS
																	DECORADOS

MAMPARAS STANDARD

Correderas

Solid



Side



Moon



Batientes

Star

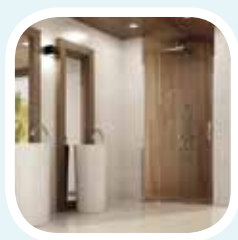

Fijas

Wall



		SOLID	STANDARD
		SIDE	
		MOON	
		STAR	
		WALL	
		SOLID	
		SIDE	
		MOON	
		SUITE	
		PASS	
		DUNE	
		FORUM	
		NEXUS	
		INFINITI	
		ROLLING	
		COMBI	
		STAR	
		HANDI	
		FLEX	
		NOVA	
		OPEN	
		QUADRO	
		NATURE	
		STYLE	
		NEXUS	
		TECHNICAL	
		ROLLING	
		INVISIBLE	
		FRAME	
		CASSONETTO	
		CLICK	
		PACK	
		HIDRA	
		DATOS TÉCNICOS	
		DECORADOS	

SOLID STANDARD



• Ruedas superiores regulables



• Ruedas inferiores con liberador .



• Perfil a pared con imán y expansión de 20 mm



• Tirador metálico



• Esquinero superior

- B** BRILLO
- B** BRILLO
- B** BRILLO
- B** BRILLO
- BLACK LINE** **B** BRILLO
- B** BRILLO
- B** BRILLO
- BLACK LINE** **B** BRILLO
- B** BRILLO
- B** BRILLO
- M** MATEADO **B** BRILLO
- M** MATEADO **B** BRILLO
- M** MATEADO **BLACK LINE** **B** BRILLO
- B** BRILLO
- B** BRILLO
- BLACK LINE** **B** BRILLO
- BLACK LINE** **B** BRILLO
- B** BRILLO
- B** BRILLO
- BLACK LINE** **B** BRILLO
- B** BRILLO
- BLACK LINE** **B** BRILLO
- BLACK LINE** **B** BRILLO
- M** MATEADO
- M** MATEADO **BLACK LINE**
- B** BRILLO
- B** BRILLO
- M** MATEADO
- M** MATEADO **BLACK LINE**
- M** MATEADO
- M** MATEADO **BLACK LINE**
- M** MATEADO **BLACK LINE** **B** BRILLO
- C** COBRE **BLACK LINE** **B** BRILLO

SOLID
SIDE
MOON
STAR
WALL
SOLID
SIDE
MOON
SUITE
PASS
DUNE
FORUM
NEXUS
INFINITI
ROLLING
COMBI
STAR
HANDI
FLEX
NOVA
OPEN
QUADRO
NATURE
STYLE
NEXUS
TECHNICAL
ROLLING
INVISIBLE
FRAME
CASSONETTO
CLICK
PACK
HIDRA
DATOS TÉCNICOS
DECORADOS





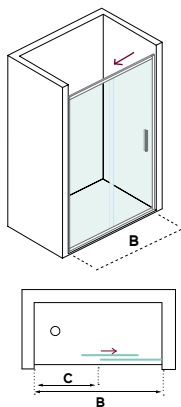

SOLID





SL2



Características

-  1 Fijo y 1 puerta corredera
-  Espesor vidrio 6mm
-  Tratamiento antical a dos caras
-  Impresión tipo 2,3,4,8,17,19 opción A
-  Altura mampara 1950
-  Ruedas con ajuste vertical
-  Cierre magnético
-  Mampara reversible

Referencia	Rango Instalación	Paso aprox. C	Vidrio Transparente	Vidrio Decorado
			 BRILLO	 BRILLO
SL2100	97 – 101	41	277	327
SL2105	102 – 106	43,5	285	335
SL2110	107 – 111	46	292	342
SL2115	112 – 116	48,5	299	349
SL2120	117 – 121	51	307	357
SL2125	122 – 126	53,5	314	374
SL2130	127 – 131	56	321	381
SL2135	132 – 136	58,5	330	390
SL2140	137 – 141	61	338	398
SL2145	142 – 146	63,5	345	405
SL2150	147 – 151	66	354	414
SL2155	152 – 156	68,5	358	421
SL2160	157 – 161	71	364	431
SL2165	162 – 166	73,5	373	440
SL2170	167 – 171	76	378	450
SL2175	172 – 176	76	388	459
SL2180	177 – 181	76	396	470
SL2185	182 – 186	76	406	485
SL2190	187 – 191	76	416	498
SL2195	192 – 196	76	428	510
SL2200	197 – 201	76	440	523



SL3

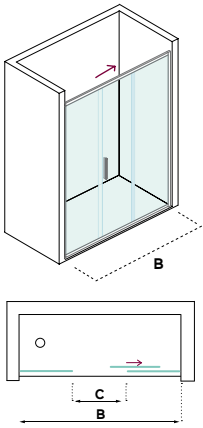

Referencia	Rango Instalación	Paso aprox. C	Vidrio Transparente	Vidrio Decorado
			B BRILLO	B BRILLO
SL3140	136 – 140	41	360	420
SL3145	141 – 145	41	366	426
SL3150	146 – 150	41	372	432
SL3155	151 – 155	41	378	438
SL3160	156 – 160	46	384	444
SL3165	161 – 165	46	391	451
SL3170	166 – 170	51	398	458
SL3175	171 – 175	51	405	465
SL3180	176 – 180	56	412	472
SL3185	181 – 185	56	419	484
SL3190	186 – 190	61	426	491
SL3195	191 – 195	61	433	498
SL3200	196 – 200	66	440	505

Características







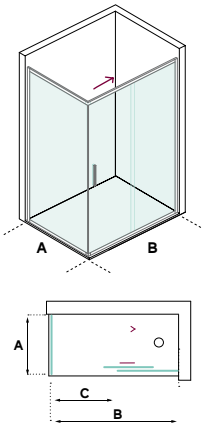

- 2 Fijos y 1 puerta corredera
- Espesor vidrio 6mm
- Tratamiento antical a dos caras
- Impresión tipo 2,3,4,8,17,19 opción A
- Altura mampara 1950
- Ruedas con ajuste vertical
- Mampara reversible





SL3A



Características

-  1 Fijo y 1 puerta corredera con lateral
-  Espesor vidrio 6mm
-  Tratamiento antical a dos caras
-  Impresión tipo 2,3,4,8,17,19 opción A
-  Altura mampara 1950
-  Ruedas con ajuste vertical
-  Cierre magnético
-  Mampara reversible

B

Referencia	Rango Instalación	Paso aprox. C	Vidrio Transparente	Vidrio Decorado
				
SL3A100B	96 – 98	42	227	282
SL3A105B	101 – 103	44,5	231	286
SL3A110B	106 – 108	47	235	290
SL3A115B	111 – 113	49,5	240	295
SL3A120B	116 – 118	52	244	299
SL3A125B	121 – 123	54,5	252	317
SL3A130B	126 – 128	57	261	326
SL3A135B	131 – 133	59,5	269	334
SL3A140B	136 – 138	62	277	342
SL3A145B	141 – 143	64,5	285	350
SL3A150B	146 – 148	67	295	360
SL3A155B	151 – 153	69,5	304	369
SL3A160B	156 – 158	72	313	378
SL3A165B	161 – 163	74,5	321	386
SL3A170B	166 – 168	77	331	396
SL3A175B	171 – 173	77	340	405
SL3A180B	176 – 178	77	349	414
SL3A185B	181 – 183	77	358	433
SL3A190B	186 – 188	77	368	443
SL3A195B	191 – 193	77	377	452
SL3A200B	196 – 198	77	386	461

A

SL3A070A	68 – 70	-	183	228
SL3A075A	73 – 75	-	191	236
SL3A080A	78 – 80	-	198	243
SL3A085A	83 – 85	-	204	249
SL3A090A	88 – 90	-	211	256
SL3A095A	93 – 95	-	218	263
SL3A100A	98 – 100	-	225	270



SOLID

SL4

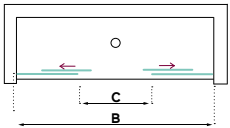
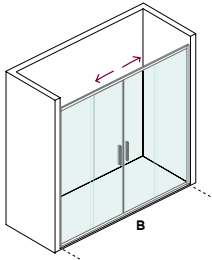

Referencia	Rango Instalación	Paso aprox. C	Vidrio Transparente	Vidrio Decorado
			B BRILLO	B BRILLO
SL4140	136 – 140	58	396	466
SL4145	141 – 145	58	403	473
SL4150	146 – 150	63	409	479
SL4155	151 – 155	63	416	486
SL4160	156 – 160	68	422	492
SL4165	161 – 165	73	430	500
SL4170	166 – 170	73	438	508
SL4175	171 – 175	73	446	516
SL4180	176 – 180	78	453	523
SL4185	181 – 185	78	461	536
SL4190	186 – 190	83	469	544
SL4195	191 – 195	83	476	551
SL4200	196 – 200	88	484	559

Características

- 2 Fijos y 2 puertas correderas
- Espesor vidrio 6mm
- Tratamiento antical a dos caras
- Impresión tipo 2,3,4,8,17,19 opción A
- Altura mampara 1950
- Ruedas con ajuste vertical
- Cierre magnético
- Mampara reversible

SOLID STANDARD

SOLID



SL4A

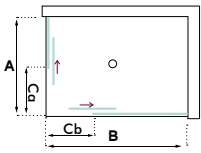
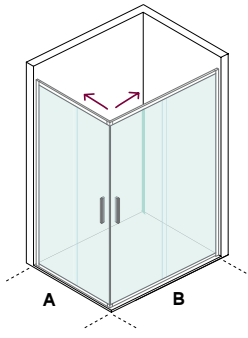

B

A

Características generales

- 2 Fijos y 2 puertas correderas
- Espesor vidrio 6mm
- Tratamiento antical a dos caras
- Impresión tipo 2,3,4,8,17,19 opción A
- Altura mampara 1950
- Ruedas con ajuste vertical
- Cierre magnético
- Mampara reversible

Hueco de paso mínimo

Para el cálculo del paso, utilizaremos esta fórmula .

$$\text{Paso} = \sqrt{Ca^2 + Cb^2}$$

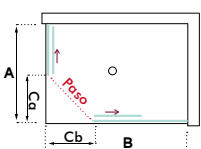

Referencia	Rango Instalación	Paso aprox. Cb	Vidrio Transparente	Vidrio Decorado
SL4A070B	68 – 70	26,5	191	236
SL4A075B	73 – 75	29	196	241
SL4A080B	78 – 80	31,5	200	245
SL4A085B	83 – 85	34	206	251
SL4A090B	88 – 90	36,5	211	256
SL4A095B	93 – 95	39	217	262
SL4A100B	98 – 100	41,5	222	272
SL4A105B	103 – 105	44	229	279
SL4A110B	108 – 110	46,5	235	285
SL4A115B	113 – 115	49	242	292
SL4A120B	118 – 120	51,5	248	298
SL4A125B	123 – 125	51,5	254	304
SL4A130B	128 – 130	51,5	261	321
SL4A135B	133 – 135	51,5	267	327
SL4A140B	138 – 140	51,5	274	334
SL4A145B	143 – 145	51,5	287	347
SL4A150B	148 – 150	51,5	300	360
SL4A155B	153 – 155	51,5	314	374
SL4A160B	158 – 160	51,5	327	387

Referencia	Rango Instalación	Paso aprox. Ca	Vidrio Transparente	Vidrio Decorado
SL4A070A	68 – 70	26,5	191	236
SL4A075A	73 – 75	29	196	241
SL4A080A	78 – 80	31,5	200	245
SL4A085A	83 – 85	34	206	251
SL4A090A	88 – 90	36,5	211	256
SL4A095A	93 – 95	39	217	262
SL4A100A	98 – 100	41,5	222	272
SL4A105A	103 – 105	44	229	279
SL4A110A	108 – 110	46,5	235	285
SL4A115A	113 – 115	49	242	292
SL4A120A	118 – 120	51,5	248	298
SL4A125A	123 – 125	51,5	254	304
SL4A130A	128 – 130	51,5	261	321
SL4A135A	133 – 135	51,5	267	327
SL4A140A	138 – 140	51,5	274	334
SL4A145A	143 – 145	51,5	287	347
SL4A150A	148 – 150	51,5	300	360
SL4A155A	153 – 155	51,5	314	374
SL4A160A	158 – 160	51,5	327	387

SIDE

STANDARD

SIDE



• Ruedas regulables



• Tirador metálico



• Guiador metálico



• Vierteaguas y remates metálicos



• Esquinero superior en ABS

- B** BRILLO
- B** BRILLO
- B** BRILLO
- B** BRILLO
- BLACK LINE** **B** BRILLO
- B** BRILLO
- B** BRILLO
- BLACK LINE** **B** BRILLO
- B** BRILLO
- B** BRILLO
- M** MATEADO **B** BRILLO
- M** MATEADO **B** BRILLO
- M** MATEADO **BLACK LINE** **B** BRILLO
- B** BRILLO
- B** BRILLO
- BLACK LINE** **B** BRILLO
- BLACK LINE** **B** BRILLO
- B** BRILLO
- B** BRILLO
- BLACK LINE** **B** BRILLO
- B** BRILLO
- BLACK LINE** **B** BRILLO
- BLACK LINE** **B** BRILLO
- M** MATEADO
- M** MATEADO **BLACK LINE**
- B** BRILLO
- B** BRILLO
- M** MATEADO
- M** MATEADO **BLACK LINE**
- M** MATEADO
- M** MATEADO **BLACK LINE**
- M** MATEADO **BLACK LINE** **B** BRILLO
- C** COBRE **BLACK LINE** **B** BRILLO

SOLID
SIDE
MOON
STAR
WALL
SOLID
SIDE
MOON
SUITE
PASS
DUNE
FORUM
NEXUS
INFINITI
ROLLING
COMBI
STAR
HANDI
FLEX
NOVA
OPEN
QUADRO
NATURE
STYLE
NEXUS
TECHNICAL
ROLLING
INVISIBLE
FRAME
CASSONETTO
CLICK
PACK
HIDRA
DATOS TÉCNICOS
DECORADOS

SIDE



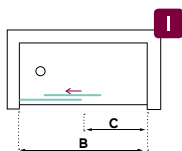
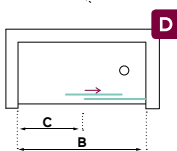
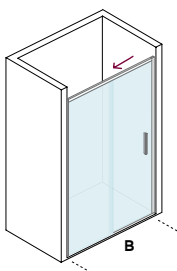

SD2



Características generales

-  1 Fijo y 1 puerta corredera
-  Espesor vidrio 6mm
-  Tratamiento antical a dos caras
-  Impresión tipo 2,3,4,8,17,19 opción A
-  Altura mampara 1950
-  Ruedas con ajuste vertical
-  Cierre magnético

Referencia	Rango Instalación	Paso aprox. C	Vidrio Transparente	Vidrio Decorado
			 BRILLO	 BRILLO
SD2100	97 – 101	41	326	376
SD2105	102 – 106	43,5	333	383
SD2110	107 – 111	46	340	390
SD2115	112 – 116	48,5	348	398
SD2120	117 – 121	51	355	405
SD2125	122 – 126	53,5	362	422
SD2130	127 – 131	56	370	430
SD2135	132 – 136	58,5	377	437
SD2140	137 – 141	61	384	444
SD2145	142 – 146	63,5	392	452
SD2150	147 – 151	66	399	459
SD2155	152 – 156	68,5	406	466
SD2160	157 – 161	71	414	474
SD2165	162 – 166	73,5	421	481
SD2170	167 – 171	76	428	488
SD2175	172 – 176	76	436	496
SD2180	177 – 181	76	443	503
SD2185	182 – 186	76	450	515
SD2190	187 – 191	76	458	523
SD2195	192 – 196	76	465	530
SD2200	197 – 201	76	473	538



SIDE

SD2V

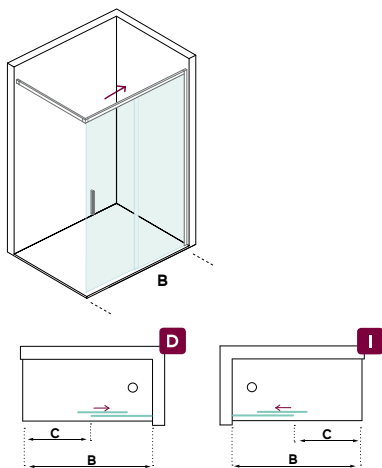

Referencia	Rango Instalación	Paso aprox C	Vidrio Transparente	Vidrio Decorado
			BRILLO	BRILLO
SD2V100	98 – 100	42,5	315	365
SD2V105	103 – 105	42,5	322	372
SD2V110	108 – 110	42,5	330	380
SD2V115	113 – 115	42,5	337	387
SD2V120	118 – 120	42,5	344	394
SD2V125	123 – 125	42,5	352	412
SD2V130	128 – 130	42,5	359	419
SD2V135	133 – 135	42,5	366	426
SD2V140	138 – 140	42,5	374	434

Características generales





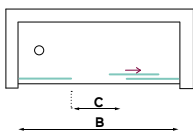
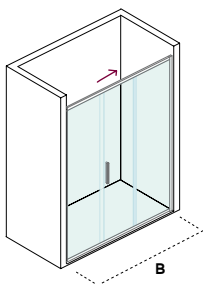

- 1 Fijo y 1 puerta corredera
- Espesor vidrio 6mm
- Tratamiento antical a dos caras
- Impresión tipo 2,3,4,8,17,19 opción A
- Altura mampara 1950
- Ruedas con ajuste vertical





SD3



Características generales

-  2 fijos y 1puerta corredera
-  Espesor vidrio 6mm
-  Tratamiento antical a dos caras
-  Impresión tipo 2,3,4,8,17,19 opción A
-  Altura mampara 1950
-  Ruedas con ajuste vertical

Referencia	Rango Instalación	Paso aprox. C	Vidrio Transparente	Vidrio Decorado
			 BRILLO	 BRILLO
SD3140	136 – 140	41	427	487
SD3145	141 – 145	41	434	494
SD3150	146 – 150	41	441	501
SD3155	151 – 155	41	448	508
SD3160	156 – 160	46	455	515
SD3165	161 – 165	46	462	522
SD3170	166 – 170	51	468	528
SD3175	171 – 175	51	476	536
SD3180	176 – 180	56	483	543
SD3185	181 – 185	56	489	554
SD3190	186 – 190	61	496	561
SD3195	191 – 195	61	503	568
SD3200	196 – 200	66	509	574



SD4

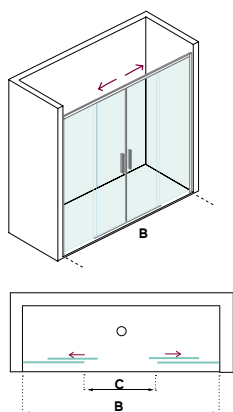

Referencia	Rango Instalación	Paso aprox. C	Vidrio Transparente	Vidrio Decorado
			BRILLO	BRILLO
SD4140	136 – 140	58	461	531
SD4145	141 – 145	58	468	538
SA4150	146 – 150	63	476	546
SD4155	151 – 155	63	484	554
SD4160	156 – 160	68	490	560
SD4165	161 – 165	73	499	569
SD4170	166 – 170	73	506	576
SD4175	171 – 175	73	513	583
SD4180	176 – 180	78	521	591
SD4185	181 – 185	78	528	603
SD4190	186 – 190	83	535	610
SD4195	191 – 195	83	543	618
SD4200	196 – 200	88	550	625

Características generales

- 2 Fijos y 2 puerta correderas
- Espesor vidrio 6mm
- Tratamiento antical a dos caras
- Impresión tipo 2,3,4,8,17,19 opción A
- Altura mampara 1950
- Ruedas con ajuste vertical
- Cierre magnético

SIDE

STANDARD

SIDE



SD3A

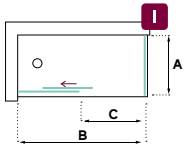
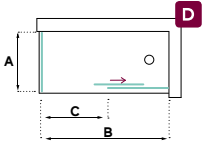
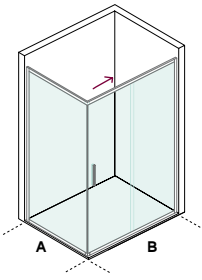

Características generales

- 1 Fijo y 1 puerta corredera con lateral
- Espesor vidrio 6mm
- Tratamiento antical a dos caras
- Impresión tipo 2,3,4,8,17,19 opción A
- Altura mampara 1950
- Ruedas con ajuste vertical
- Cierre magnético

B

A

Referencia	Rango Instalación	Paso aprox. C	Vidrio Transparente	Vidrio Decorado
SD3A100B	96 – 98	42	244	299
SD3A105B	101 – 103	44,5	250	305
SD3A110B	106 – 108	47	258	313
SD3A115B	111 – 113	49,5	264	319
SD3A120B	116 – 118	52	271	326
SD3A125B	121 – 123	54,5	278	343
SD3A130B	126 – 128	57	284	349
SD3A135B	131 – 133	59,5	291	356
SD3A140B	136 – 138	62	298	363
SD3A145B	141 – 143	64,5	305	370
SD3A150B	146 – 148	67	312	377
SD3A155B	151 – 153	69,5	318	383
SD3A160B	156 – 158	72	325	390
SD3A165B	161 – 163	74,5	331	396
SD3A170B	166 – 168	77	338	403
SD3A175B	171 – 173	77	346	411
SD3A180B	176 – 178	77	353	418
SD3A185B	181 – 183	77	362	437
SD3A190B	186 – 188	77	370	445
SD3A195B	191 – 193	77	377	452
SD3A200B	196 – 198	77	385	460

SD3A070A	68 – 70	-	166	211
SD3A075A	73 – 75	-	172	217
SD3A080A	78 – 80	-	179	224
SD3A085A	83 – 85	-	185	230
SD3A090A	88 – 90	-	194	239
SD3A095A	93 – 95	-	202	247
SD3A100A	98 – 100	-	210	255

SIDE

STANDARD

SIDE



SD4A

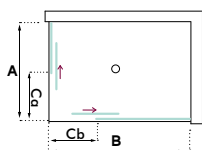
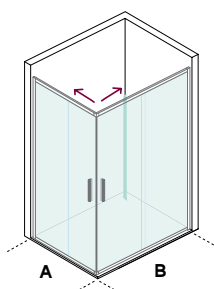

B

Características generales

- 2 Fijos y 2 puertas correderas
- Espesor vidrio 6mm
- Tratamiento antical a dos caras
- Impresión tipo 2,3,4,8,17,19 opción A
- Altura mampara 1950
- Ruedas con ajuste vertical
- Cierre magnético en el vértice

A

Referencia	Rango Instalación	Paso aprox. Cb	Vidrio Transparente	Vidrio Decorado
			BRILLO	BRILLO
SD4A070B	68 – 70	26 ,5	221	266
SD4A075B	73 – 75	29	228	273
SD4A080B	78 – 80	31,5	234	279
SD4A085B	83 – 85	34	241	286
SD4A090B	88 – 90	36,5	248	293
SD4A095B	93 – 95	39	254	299
SD4A100B	98 – 100	41,5	261	311
SD4A105B	103 – 105	44	270	320
SD4A110B	108 – 110	46, 5	276	326
SD4A115B	113 – 115	49	283	333
SD4A120B	118 – 120	51,5	289	339
SD4A125B	123 – 125	51,5	296	346
SD4A130B	128 – 130	51,5	303	363
SD4A135B	133 – 135	51,5	309	369
SD4A140B	138 – 140	51,5	316	376
SD4A145B	143 – 145	51,5	323	383
SD4A150B	148 – 150	51,5	331	391
SD4A155B	153 – 155	51,5	339	399
SD4A160B	158 – 160	51,5	347	407

Referencia	Rango Instalación	Paso aprox. Ca	Vidrio Transparente	Vidrio Decorado
			BRILLO	BRILLO
SD4A070A	68 – 70	26,5	221	266
SD4A075A	73 – 75	29	228	273
SD4A080A	78 – 80	31,5	234	279
SD4A085A	83 – 85	34	241	286
SD4A090A	88 – 90	36,5	248	293
SD4A095A	93 – 95	39	254	299
SD4A100A	98 – 100	41,5	261	311
SD4A105A	103 – 105	44	270	320
SD4A110A	108 – 110	46, 5	276	326
SD4A115A	113 – 115	49	283	333
SD4A120A	118 – 120	51,5	289	339
SD4A125A	123 – 125	51,5	296	346
SD4A130A	128 – 130	51,5	303	363
SD4A135A	133 – 135	51,5	309	369
SD4A140A	138 – 140	51,5	316	376
SD4A145A	143 – 145	51,5	323	383
SD4A150A	148 – 150	51,5	331	391
SD4A155A	153 – 155	51,5	339	399
SD4A160A	158 – 160	51,5	347	407

Hueco de paso mínimo

Para el cálculo del paso, utilizaremos esta fórmula .

$$\text{Paso} = \sqrt{Ca^2 + Cb^2}$$

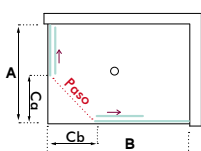

MOON STANDARD

MOON



• Ruedas regulables



• Tirador metálico.

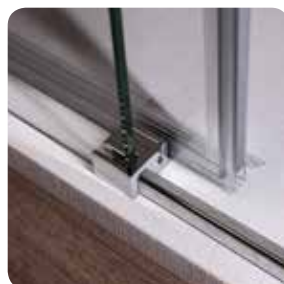

• Guiador metálico

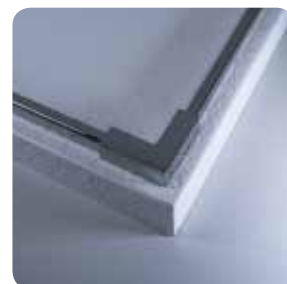

• Vierteaguas y remates metálicos



• Cierre magnético a pared

- B** BRILLO
- B** BRILLO
- B** BRILLO
- B** BRILLO
- BLACK LINE** **B** BRILLO
- B** BRILLO
- BLACK LINE** **B** BRILLO
- B** BRILLO
- B** BRILLO
- M** MATEADO **B** BRILLO
- M** MATEADO **B** BRILLO
- M** MATEADO **BLACK LINE** **B** BRILLO
- B** BRILLO
- B** BRILLO
- BLACK LINE** **B** BRILLO
- BLACK LINE** **B** BRILLO
- B** BRILLO
- B** BRILLO
- BLACK LINE** **B** BRILLO
- B** BRILLO
- BLACK LINE** **B** BRILLO
- BLACK LINE** **B** BRILLO
- M** MATEADO
- M** MATEADO **BLACK LINE**
- B** BRILLO
- B** BRILLO
- M** MATEADO
- M** MATEADO **BLACK LINE**
- M** MATEADO
- M** MATEADO **BLACK LINE**
- M** MATEADO **BLACK LINE** **B** BRILLO
- C** COBRE **BLACK LINE** **B** BRILLO

- SOLID
- SIDE
- MOON
- STAR
- WALL
- SOLID
- SIDE
- MOON
- SUITE
- PASS
- DUNE
- FORUM
- NEXUS
- INFINITI
- ROLLING
- COMBI
- STAR
- HANDI
- FLEX
- NOVA
- OPEN
- QUADRO
- NATURE
- STYLE
- NEXUS
- TECHNICAL
- ROLLING
- INVISIBLE
- FRAME
- CASSONETTO
- CLICK
- PACK
- HIDRA
- DATOS TÉCNICOS
- DECORADOS







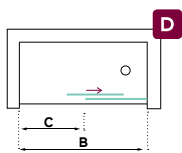
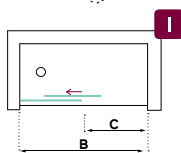
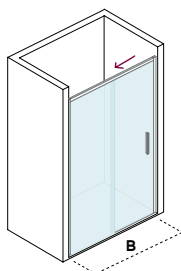

NOOK





MO2



Características generales

-  1 fijo y 1 puerta corredera
-  Espesor vidrio 6mm
-  Tratamiento antical a dos caras
-  Impresión tipo 2,3,4,8,17,19 opción A
-  Altura mampara 1950
-  Ruedas con ajuste vertical
-  Cierre magnético
-  Mampara reversible
-  Mampara en Stock, servicio inmediato



Referencia	Rango de Instalación	Paso aprox. C	Vidrio Transparente	Vidrio Decorado
			 BRILLO	 BRILLO
MO2100	96 – 99	40	290	340
MO2105	100 – 104	41,5	296	346
MO2110	105 – 109	44	303	353
MO2115	110 – 114	46,5	311	361
MO2120	115 – 119	49	318	368
MO2125	120 – 124	51,5	325	385
MO2130	125 – 129	55	333	393
MO2135	130 – 134	56,5	340	400
MO2140	135 – 139	59	348	408
MO2145	140 – 144	61,5	355	415
MO2150	145 – 149	64	363	423
MO2155	150 – 154	66,5	370	430
MO2160	155 – 159	69	377	437
MO2165	160 – 164	72,5	385	445
MO2170	165 – 169	74,5	392	452
MO2175	170 – 174	74,5	400	460
MO2180	175 – 179	74,5	407	467
MO2185	180 – 184	74,5	414	479
MO2190	185 – 189	74,5	422	487
MO2195	190 – 194	74,5	429	494
MO2200	195 – 199	74,5	437	502





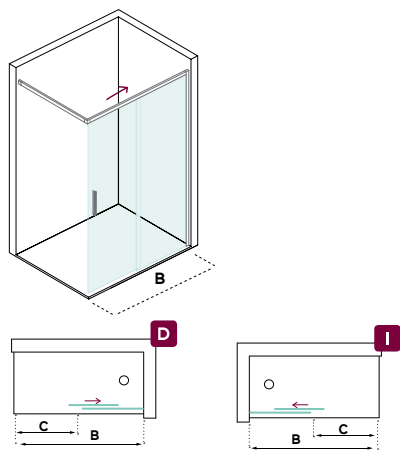



MO2V



Referencia	Rango de Instalación	Paso aprox. C	Vidrio Transparente	Vidrio Decorado
			B BRILLO	B BRILLO
M02V100	96 – 100	43	274	324
M02V105	101 – 105	43	279	329
M02V110	106 – 110	43	286	336
M02V115	111 – 115	43	293	343
M02V120	116 – 120	43	300	350
M02V125	121 – 125	43	307	367
M02V130	126 – 130	43	314	374
M02V135	131 – 135	43	321	381
M02V140	136 – 140	43	328	388

Características generales

-  1 fijo y 1 puerta corredera
-  Espesor vidrio 6mm
-  Tratamiento antical a dos caras
-  Impresión tipo 2,3,4,8,17,19 opción A
-  Altura mampara 1950
-  Ruedas con ajuste vertical
-  Mampara reversible

MOON STANDARD



MOON



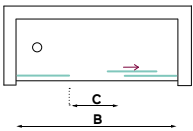
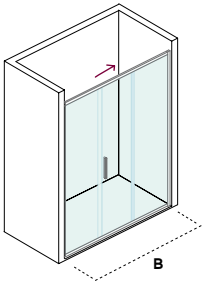

MO3



Características generales

-  2 fijos y 1 puerta corredera
-  Espesor vidrio 6mm
-  Tratamiento antical a dos caras
-  Impresión tipo 2,3,4,8,17,19 opción A
-  Altura mampara 1950
-  Ruedas con ajuste vertical
-  Cierre magnético
-  Mampara reversible

Referencia	Rango Instalación	Paso aprox. C	Vidrio Transparente	Vidrio Decorado
				
MO3140	135 – 139	40	405	465
MO3145	140 – 144	40	412	472
MO3150	145 – 149	42	420	480
MO3155	150 – 154	45	427	487
MO3160	155 – 159	45	434	494
MO3165	160 – 164	47	441	501
MO3170	165 – 169	50	447	507
MO3175	170 – 174	50	456	516
MO3180	175 – 179	52	462	522
MO3185	180 – 184	55	469	534
MO3190	185 – 189	55	476	541
MO3195	190 – 194	55	483	548
MO3200	195 – 199	60	488	553





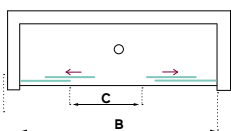
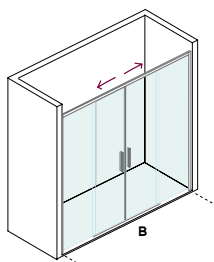





MO4



Referencia	Rango Instalación	Paso aprox. C	Vidrio Transparente	Vidrio Decorado
			B BRILLO	B BRILLO
MO4140	136 – 140	56	425	495
MO4145	141 – 145	56	432	502
MO4150	146 – 150	61	440	510
MO4155	151 – 155	61	448	518
MO4160	156 – 160	66	454	524
MO4165	161 – 165	66	462	532
MO4170	166 – 170	71	469	539
MO4175	171 – 175	71	477	547
MO4180	176 – 180	76	484	554
MO4185	181 – 185	76	492	567
MO4190	186 – 190	81	499	574
MO4195	191 – 195	81	506	581
MO4200	196 – 200	86	511	586

Características generales

-  2 Fijos y 2 puertas correderas con lateral
-  Espesor vidrio 6mm
-  Tratamiento antical a dos caras
-  Impresión tipo 2,3,4,8,17,19 opción A
-  Altura mampara 1950
-  Ruedas con ajuste vertical
-  Cierre magnético
-  Mampara reversible

MOON STANDARD

MOON



MO3A

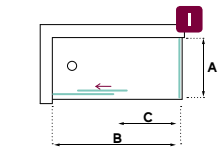
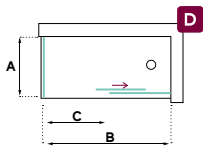
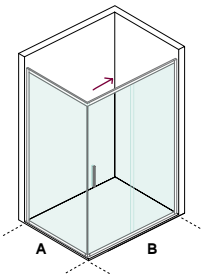



Características generales

-  1 Fijo y 1 puerta corredera con lateral
-  Espesor vidrio 6mm
-  Tratamiento antical a dos caras
-  Impresión tipo 2,3,4,8,17,19 opción A
-  Altura mampara 1950
-  Ruedas con ajuste vertical
-  Cierre magnético
-  Mampara reversible

B

A

Referencia	Rango Instalación	Paso aprox. C	Vidrio Transparente	Vidrio Decorado
				
M03A100B	96 – 100	39	244	299
M03A105B	101 – 105	41,5	250	305
M03A110B	106 – 110	44	258	313
M03A115B	111 – 115	46,5	264	319
M03A120B	116 – 120	49	271	326
M03A125B	121 – 125	51,5	278	343
M03A130B	126 – 130	54	284	349
M03A135B	131 – 135	56,5	291	356
M03A140B	136 – 140	59	298	363
M03A145B	141 – 145	61,5	305	370
M03A150B	146 – 150	64	312	377
M03A155B	151 – 155	66,5	318	383
M03A160B	156 – 160	69	325	390
M03A165B	161 – 165	71,5	331	396
M03A170B	166 – 170	74,5	338	403
M03A175B	171 – 175	74,5	346	411
M03A180B	176 – 180	74,5	353	418
M03A185B	181 – 185	74,5	362	437
M03A190B	186 – 190	74,5	370	445
M03A195B	191 – 195	74,5	377	452
M03A200B	196 – 200	74,5	385	460

M03A070A	68 – 69	-	166	211
M03A075A	73 – 74	-	172	217
M03A080A	78 – 79	-	179	224
M03A085A	83 – 84	-	185	230
M03A090A	88 – 89	-	194	239
M03A095A	93 – 94	-	202	247
M03A100A	98 – 99	-	210	255



MO4A

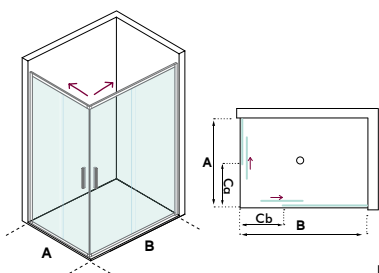

B

Características generales

- 2 Fijos y 2 puertas correderas
- Espesor vidrio 6mm
- Tratamiento antical a dos caras
- Impresión tipo 2,3,4,8,17,19 opción A
- Altura mampara 1950
- Ruedas con ajuste vertical
- Cierre magnético
- Mampara reversible
- Mampara en Stock, servicio inmediato

Hueco de paso mínimo

Para el cálculo del paso, utilizaremos esta fórmula.

$$\text{Paso} = \sqrt{Ca^2 + Cb^2}$$

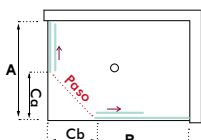

A

Referencia	Rango Instalación	Paso aprox. Cb / Ca	Vidrio Transparente	Vidrio Decorado
			B BRILLO	B BRILLO
MO4A070B	67 – 70	24,5	217	262
MO4A075B	72 – 75	27	224	269
MO4A080B	77 – 80	29,5	231	276
MO4A085B	82 – 85	32	238	283
MO4A090B	87 – 90	34,5	245	290
MO4A095B	92 – 95	37	252	297
MO4A100B	97 – 100	39,5	259	309
MO4A105B	102 – 105	42	266	316
MO4A110B	107 – 110	44,5	273	323
MO4A115B	112 – 115	47	279	329
MO4A120B	117 – 120	49,5	286	336
MO4A125B	122 – 125	50	293	343
MO4A130B	127 – 130	50	300	360
MO4A135B	132 – 135	50	307	367
MO4A140B	137 – 140	50	314	374
MO4A145B	142 – 145	50	321	381
MO4A150B	147 – 150	50	328	388
MO4A155B	152 – 155	50	335	395
MO4A160B	157 – 160	50	342	402

MO4A070A	67 – 70	24,5	207	252
MO4A075A	72 – 75	27	214	259
MO4A080A	77 – 80	29,5	221	266
MO4A085A	82 – 85	32	228	273
MO4A090A	87 – 90	34,5	235	280
MO4A095A	92 – 95	37	242	292
MO4A100A	97 – 100	39,5	249	299
MO4A105A	102 – 105	42	256	306
MO4A110A	107 – 110	44,5	263	313
MO4A115A	112 – 115	47	269	319
MO4A120A	117 – 120	49,5	276	326
MO4A125A	122 – 125	50	283	333
MO4A130A	127 – 130	50	290	340
MO4A135A	132 – 135	50	297	347
MO4A140A	137 – 140	50	304	354
MO4A145A	142 – 145	50	311	371
MO4A150A	147 – 150	50	318	378
MO4A155A	152 – 155	50	325	385
MO4A160A	157 – 160	50	332	392

STAR

STANDARD

STAR



• Barras de refuerzo en acero



• Tirador metálico.



• Vierteaguas y remates metálicos



• Bisagra pivotante de aluminio alto brillo.



• Cierre magnético a pared.

- B** BRILLO
- B** BRILLO
- B** BRILLO
- B** BRILLO
- BLACK LINE** **B** BRILLO
- B** BRILLO
- B** BRILLO
- BLACK LINE** **B** BRILLO
- B** BRILLO
- B** BRILLO
- M** MATEADO **B** BRILLO
- M** MATEADO **B** BRILLO
- M** MATEADO **BLACK LINE** **B** BRILLO
- B** BRILLO
- B** BRILLO
- BLACK LINE** **B** BRILLO
- BLACK LINE** **B** BRILLO
- B** BRILLO
- B** BRILLO
- BLACK LINE** **B** BRILLO
- B** BRILLO
- BLACK LINE** **B** BRILLO
- BLACK LINE** **B** BRILLO
- M** MATEADO
- M** MATEADO **BLACK LINE**
- B** BRILLO
- B** BRILLO
- M** MATEADO
- M** MATEADO **BLACK LINE**
- M** MATEADO **BLACK LINE**
- M** MATEADO **BLACK LINE**
- M** MATEADO **BLACK LINE** **B** BRILLO
- C** COBRE **BLACK LINE** **B** BRILLO

- SOLID
- SIDE
- MOON
- STAR
- WALL
- SOLID
- SIDE
- MOON
- SUITE
- PASS
- DUNE
- FORUM
- NEXUS
- INFINITI
- ROLLING
- COMBI
- STAR
- HANDI
- FLEX
- NOVA
- OPEN
- QUADRO
- NATURE
- STYLE
- NEXUS
- TECHNICAL
- ROLLING
- INVISIBLE
- FRAME
- CASSONETTO
- CLICK
- PACK
- HIDRA
- DATOS TÉCNICOS
- DECORADOS

STAR



STI

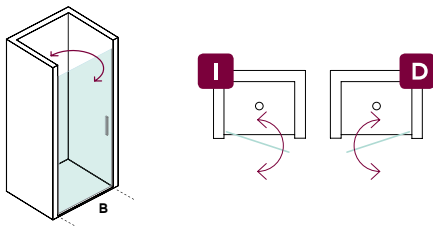

Referencia	Rango Instalación	Hueco B	Vidrio Transparente	Vidrio Decorado
			BRILLO	BRILLO
ST1070	67,5 – 69,5	60	297	332
ST1075	72,5 – 74,5	65	302	337
ST1080	77,5 – 79,5	70	308	343
ST1085	82,5 – 84,5	75	313	348
ST1090	87,5 – 89,5	80	318	353

Los dos últimos dígitos de la referencia, son la medida de la puerta

STIB

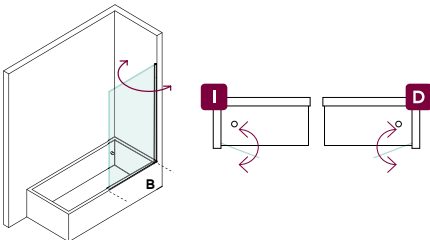

Referencia	Rango Instalación	Paso ganado	Vidrio Transparente	Vidrio Decorado
			BRILLO	BRILLO
ST1B080	78 – 80	71	216	241
ST1B090	88 – 90	81	220	245

Los dos últimos dígitos de la referencia, son la medida de la puerta

Características generales

- Puerta abatible con cierre a pared
- Altura ducha 1950, bañera 1500
- Espesor vidrio 6mm
- Cierre magnético
- Tratamiento antical a dos caras
- Apertura de puerta a 180°
- Impresión tipo 2,3,4,8,17,19 opción A



ST2R

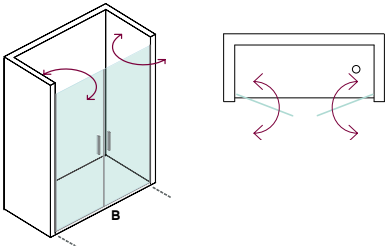

Referencia	Rango Instalación	Hueco B	Vidrio Transparente	Vidrio Decorado
			B BRILLO	B BRILLO
ST2R090	87 – 91	75	459	509
ST2R100	92 – 96	85	471	521
ST2R110	97 – 101	95	484	534
ST2R120	102 – 106	105	497	547
ST2R130	107 – 111	115	509	559
ST2R140	112 – 116	125	522	572
ST2R150	117 – 121	135	534	584
ST2R160	122 – 126	145	547	597

Los dos últimos dígitos de la referencia, son la medida de la puerta

ST2B

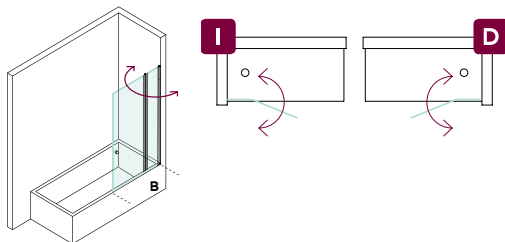

Referencia	Fijo + puerta	Paso ganado	Vidrio Transparente	Vidrio Decorado
			B BRILLO	B BRILLO
ST2B100	25+75	71	271	311
ST2B110	35+75	71	277	317

Los dos últimos dígitos de la referencia, son la medida de la puerta

Características generales

- 2 2 puertas abatibles con cierre a pared
- 6mm Espesor vidrio 6mm
- 15 Tratamiento antical a dos caras
- 180° Impresión tipo 2,3,4,8,17,19 opción A
- 1950 Altura ducha 1950 , bañera 1500
- C Cierre magnético
- 180° Apertura de puerta a 180°





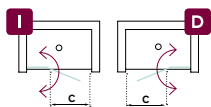
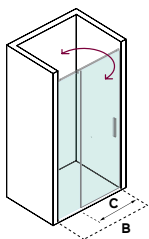



ST2



Referencia	Rango Instalación	Paso aprox. C	Vidrio Transparente	Vidrio Decorado
			B BRILLO	B BRILLO
ST208050	79 – 80,5	47	389	439
ST208550	84 – 85,5	47	394	444
ST209050	89 – 70,5	42	399	449
ST209560	94 – 95,5	57	404	454
ST210060	99 – 100,5	57	410	460
ST210560	104 – 105,5	62	415	465
ST211060	109 – 110,5	57	420	470
ST211560	114 – 115,5	57	425	475
ST212060	119 – 120,5	57	431	481
ST212565	124 – 125,5	62	436	496
ST213070	129 – 130,5	67	441	501
ST213575	134 – 135,5	67	446	506
ST214075	139 – 140,5	72	452	512

Los dos últimos dígitos de la referencia, son la medida de la puerta

Características generales





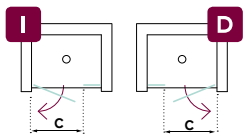
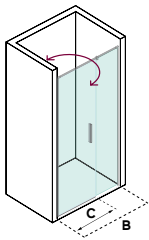

-  Fijo y Puerta abatible con cierre a pared
-  Espesor vidrio 6mm
-  Tratamiento antical a dos caras
-  Impresión tipo 2,3,4,8,17,19 opción A
-  Altura mampara 1950
-  Cierre magnético
-  Apertura de puertas a 180°



ST2F



Características generales

-  Fijo y Puerta abatible con cierre a fijo
-  Espesor vidrio 6mm
-  Tratamiento antical a dos caras
-  Impresión tipo 2,3,4,8,17,19 opción A
-  Altura mampara 1950
-  Cierre magnético
-  Apertura de puertas a 180°

Referencia	Rango Instalación	Paso aprox. C	Vidrio Transparente	Vidrio Decorado
				
ST2F08050	77,5 – 81	42	389	439
ST2F08560	82,5 – 86	52	394	444
ST2F09060	87,5 – 91	52	399	449
ST2F09560	92,5 – 96	52	404	454
ST2F10060	97,5 – 101	52	410	460
ST2F10565	102,5 – 106	57	415	465
ST2F11060	107,5 – 111	52	420	470
ST2F11565	112,5 – 116	57	425	475
ST2F12070	117,5 – 121	62	431	481
ST2F12570	122,5 – 126	62	436	496
ST2F13070	127,5 – 131	62	441	501
ST2F13575	132,5 – 136	67	446	506
ST2F14080	137,5 – 141	72	452	512





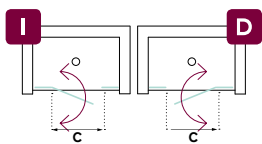
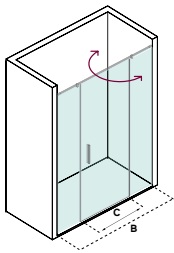

Los dos últimos dígitos de la referencia, son la medida de la puerta



ST3



Características generales

-  2 Fijos y Puerta abatible con cierre a fijo
-  Espesor vidrio 6mm
-  Tratamiento antical a dos caras
-  Impresión tipo 2,3,4,8,17,19 opción A
-  Altura mampara 1950
-  Cierre magnético
-  Apertura de puertas a 180°

Referencia	Rango Instalación	Paso aprox. C	Vidrio Transparente	Vidrio Decorado
				
ST310045	99,5 – 102,5	42,5	452	502
ST310550	104,5 – 107,5	47,5	458	508
ST311055	109,5 – 112,5	52,5	464	514
ST311555	114,5 – 117,5	52,5	470	520
ST312055	119,5 – 122,5	52,5	477	527
ST312560	124,5 – 127,5	57,5	483	543
ST313065	129,5 – 132,5	62,5	488	548
ST313565	134,5 – 137,5	62,5	494	554
ST314065	139,5 – 142,5	62,5	499	559
ST314565	144,5 – 147,5	62,5	505	565
ST315065	149,5 – 152,5	62,5	511	571
ST315565	154,5 – 157,5	62,5	518	578
ST316065	159,5 – 162,5	62,5	524	584
ST316560	164,5 – 167,5	57,5	530	590
ST317060	169,5 – 172,5	57,5	537	597
ST317560	174,5 – 177,5	57,5	543	613
ST318060	179,5 – 182,5	57,5	549	619
ST318575	184,5 – 187,5	72,5	555	625
ST319075	189,5 – 192,5	72,5	562	632
ST319575	194,5 – 197,5	72,5	568	638
ST320075	199,5 – 202,5	72,5	574	644

Los dos últimos dígitos de la referencia, son la medida de la puerta



STAR

ST4

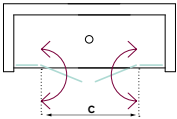
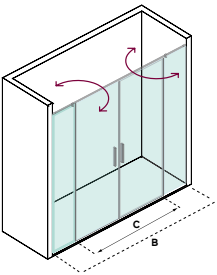

Referencia	Rango Instalación	Paso aprox. C	Vidrio Transparente	Vidrio Decorado
			BRILLO	BRILLO
ST413045	128 – 131	75	599	659
ST413545	133 – 136	75	606	666
ST414050	138 – 141	85	613	673
ST414550	143 – 146	85	621	681
ST415050	148 – 151	95	628	688
ST415555	153 – 156	95	635	705
ST416050	158 – 161	85	643	713
ST416550	163 – 166	95	650	720
ST417065	168 – 171	115	657	727
ST417555	173 – 176	95	665	735
ST418060	178 – 181	105	672	742
ST418570	183 – 186	125	679	749
ST419075	188 – 191	135	687	757
ST419575	193 – 196	135	694	764
ST420080	198 – 201	145	701	771
ST420575	203 – 206	135	709	784
ST421075	208 – 211	135	716	791
ST421575	213 – 216	135	723	798
ST422080	218 – 221	145	731	806

Los dos últimos dígitos de la referencia, son la medida de la puerta

Características generales

- 2 Fijos y 2 Puertas abatibles con cierre al centro
- Espesor vidrio 6mm
- Tratamiento antical a dos caras
- Impresión tipo 2,3,4,8,17,19 opción A
- Altura mampara 1950
- Cierre magnético
- Apertura de puertas a 180°



ST2AR

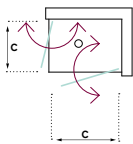
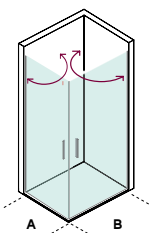

Referencia	Rango Instalación	Paso aprox. c	Vidrio Transpa-	Vidrio Decorado
			BRILLO	BRILLO
ST2AR070B	68 – 70	60	297	332
ST2AR075B	73 – 75	65	302	337
ST2AR080B	78 – 80	70	308	343
ST2AR085B	83 – 85	75	313	348
ST2AR090B	88 – 90	80	318	353

ST2AR070A	68 – 70	60	297	332
ST2AR075A	73 – 75	65	302	337
ST2AR080A	78 – 80	70	308	343
ST2AR085A	83 – 85	75	313	348
ST2AR090A	88 – 90	80	318	353

Características generales

- 2 Puertas abatibles con cierre en vértice
- Espesor vidrio 6mm
- Tratamiento antical a dos caras
- Impresión tipo 2,3,4,8,17,19 opción A
- Altura mampara 1950
- Cierre magnético
- Apertura de puertas a 180°

Los dos últimos dígitos de la referencia, son la medida de la puerta



ST2A

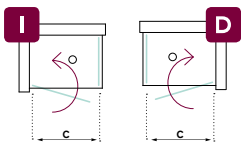
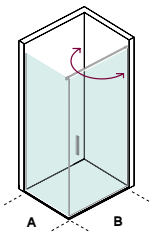







Referencia	Rango Instalación	Paso aprox. C	Vidrio Transparente	Vidrio Decorado
			B BRILLO	B BRILLO
ST2A070B	68,5 – 70,5	60	297	332
ST2A075B	73,5 – 75,5	65	302	337
ST2A080B	78,5 – 80,5	70	308	343
ST2A085B	83,5 – 85,5	75	313	348
ST2A090B	88,5 – 70,5	80	318	353

Los dos últimos dígitos de la referencia, son la medidad de la puerta

ST2A070A	70 – 71,5	-	199	234
ST2A075A	75 – 76,5	-	202	237
ST2A080A	80 – 81,5	-	205	240
ST2A085A	85 – 86,5	-	207	242
ST2A090A	90 – 91,5	-	210	245

Características generales





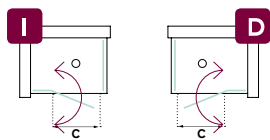
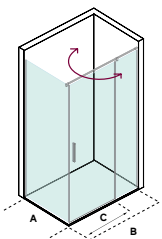

-  1 Puerta abatible con cierre a fijo lateral
-  Espesor vidrio 6mm
-  Tratamiento antical a dos caras
-  Impresión tipo 2,3,4,8,17,19 opción A
-  Altura mampara 1950
-  Cierre magnético
-  Apertura de puertas a 180°



ST3A



Características generales

-  2 Fijos y Puerta abatible con cierre a lateral
-  Espesor vidrio 6mm
-  Tratamiento antical a dos caras
-  Impresión tipo 2,3,4,8,17,19 opción A
-  Altura mampara 1950
-  Cierre magnético
-  Apertura de puertas a 180°

B

A

Referencia	Rango Instalación	Paso aprox. C	Vidrio Transparente	Vidrio Decorado
			 BRILLO	 BRILLO
ST3A08050B	80 – 81,5	470	389	439
ST3A08560B	85 – 86,5	520	394	444
ST3A09060B	90 – 91,5	520	399	449
ST3A09555B	95 – 96,5	470	404	454
ST3A10055B	100 – 101,5	470	410	460
ST3A10560B	105 – 106,5	520	415	465
ST3A11060B	110 – 111,5	520	420	470
ST3A11565B	115 – 116,5	570	425	475
ST3A12065B	120 – 121,5	570	431	481
ST3A12570B	125 – 126,5	620	436	496
ST3A13075B	130 – 131,5	670	441	501
ST3A13575B	135 – 136,5	670	446	506
ST3A14080B	140 – 141,5	720	452	512

Los dos últimos dígitos de la referencia, son la medida de la puerta

ST3A070A	69,5 – 71	-	199	234
ST3A075A	74,5 – 76	-	202	237
ST3A080A	79,5 – 81	-	205	240
ST3A085A	84,5 – 86	-	207	242
ST3A090A	89,5 – 91	-	210	245



ST4A

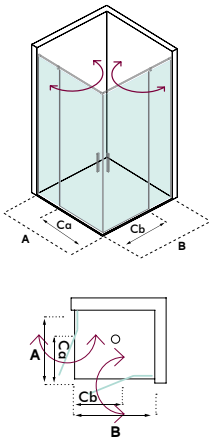

Características generales

- 2 Fijos y 2 puertas abatibles con cierre al vértice
- Espesor vidrio 6mm
- Tratamiento antical a dos caras
- Impresión tipo 2,3,4,8,17,19 opción A
- Altura mampara 1950
- Cierre magnético
- Apertura de puertas a 180°

Referencia	Rango Instalación	Paso aprox. Ca/Cb	Vidrio Transparente	Vidrio Decorado
			BRILLO	BRILLO
ST4A07045B	69,5 – 71	420	360	410
ST4A07550B	74,5 – 76	470	365	415
ST4A08050B	79,5 – 81	520	370	420
ST4A08560B	84,5 – 86	570	375	425
ST4A09065B	89,5 – 91	620	380	430
ST4A09560B	94,5 – 96	570	385	435
ST4A10065B	99,5 – 101	620	390	440
ST4A10570B	104,5 – 106	670	395	445
ST4A11075B	109,5 – 111	720	400	450
ST4A11580B	114,5 – 116	770	405	455
ST4A12085B	119,5 – 121	820	410	460

ST4A07045A	69,5 – 71	420	360	410
ST4A07550A	74,5 – 76	470	365	415
ST4A08050A	79,5 – 81	520	370	420
ST4A08560A	84,5 – 86	570	375	425
ST4A09065A	89,5 – 91	620	380	430
ST4A09560A	94,5 – 96	570	385	435
ST4A10065A	99,5 – 101	620	390	440
ST4A10570A	104,5 – 106	670	395	445
ST4A11075A	109,5 – 111	720	400	450
ST4A11580A	114,5 – 116	770	405	455
ST4A12085A	119,5 – 121	820	410	460

Los dos últimos dígitos de la referencia, son la medida de la puerta

WALL STANDARD

WALL

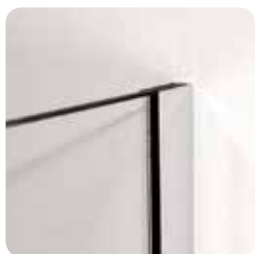

• Perfil de aluminio brillo



• Soporte a pared en acero articulable a 180°.



• Brazo extensible desde 645mm a 1000mm

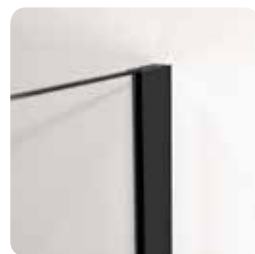

• Perfil a pared, en aluminio acabado negro mate



• Soporte a pared articulable a 180°. acabado negro mate



• Brazo extensible desde 645mm a 1000mm acabado negro mate

- B** BRILLO
- B** BRILLO
- B** BRILLO
- B** BRILLO
- BLACK LINE** **B** BRILLO
- B** BRILLO
- BLACK LINE** **B** BRILLO
- B** BRILLO
- B** BRILLO
- M** MATEADO **B** BRILLO
- M** MATEADO **B** BRILLO
- M** MATEADO **BLACK LINE** **B** BRILLO
- B** BRILLO
- B** BRILLO
- BLACK LINE** **B** BRILLO
- BLACK LINE** **B** BRILLO
- B** BRILLO
- B** BRILLO
- BLACK LINE** **B** BRILLO
- B** BRILLO
- BLACK LINE** **B** BRILLO
- BLACK LINE** **B** BRILLO
- M** MATEADO **B** BRILLO
- M** MATEADO **BLACK LINE**
- B** BRILLO
- B** BRILLO
- M** MATEADO
- M** MATEADO **BLACK LINE**
- M** MATEADO
- M** MATEADO **BLACK LINE**
- M** MATEADO **BLACK LINE** **B** BRILLO
- C** COBRE **BLACK LINE** **B** BRILLO

SOLID
SIDE
MOON
STAR
WALL
SOLID
SIDE
MOON
SUITE
PASS
DUNE
FORUM
NEXUS
INFINITI
ROLLING
COMBI
STAR
HANDI
FLEX
NOVA
OPEN
QUADRO
NATURE
STYLE
NEXUS
TECHNICAL
ROLLING
INVISIBLE
FRAME
CASSONETTO
CLICK
PACK
HIDRA
DATOS TÉCNICOS
DECORADOS

WALL



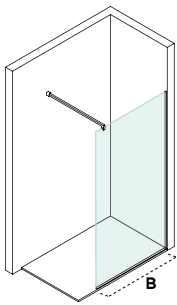

WL1



Características generales

-  1 Fijo con brazo a pared
-  Espesor vidrio 6 mm
-  Espesor vidrio 8 mm
-  Tratamiento antical a dos caras
-  Impresión tipo 2,3,4,8,17,19 opción A
-  Altura mampara 1950
-  Mampara en Stock, servicio inmediato



Referencia	Rango Instalación B	Vidrio Transparente	Vidrio Decorado
			
WL18070	67,5 – 68,5	216	251
WL18075	72,5 – 73,5	221	256
WL18080	77,5 – 78,5	227	262
WL18085	82,5 – 83,5	232	267
WL18090	89 – 90	241	276
WL18100	99 – 100	252	292
WL18110	109 – 110	263	303
WL18120	119 – 120	273	313

WL16070	67,5 – 68,5	199	234
WL16080	77,5 – 78,5	205	240
WL16090	89 – 90	210	245
WL16100	99 – 100	221	256



WL2

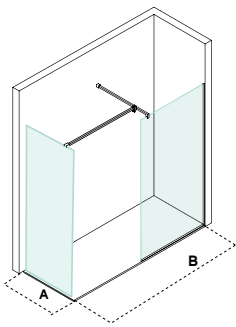

Características generales

- 2 Fijos con brazo a pared
- Espesor vidrio 6 mm
- Espesor vidrio 8 mm
- Tratamiento antical a dos caras
- Impresión tipo 2,3,4,8,17,19 opción A
- Altura mampara 1950

Referencia	Rango Instalación B	Vidrio Transparente	Vidrio Decorado
		B BRILLO	B BRILLO
WL18070	67,5 – 68,5	216	251
WL18075	72,5 – 73,5	221	256
WL18080	77,5 – 78,5	227	262
WL18085	82,5 – 83,5	232	267
WL18090	89 – 90	241	276
WL18100	99 – 100	252	292
WL18110	109 – 110	263	303
WL18120	119 – 120	273	313

WL28070	67,5 – 68,5	216	251
WL28075	72,5 – 73,5	221	256
WL28080	77,5 – 78,5	227	262
WL28085	82,5 – 83,5	232	267
WL28090	89 – 90	241	276
WL28100	99 – 100	252	292

WL16070	67,5 – 68,5	199	234
WL16080	77,5 – 78,5	205	240
WL16090	89 – 90	210	245
WL16100	99 – 100	221	256

WL26070	67,5 – 68,5	199	234
WL26080	77,5 – 78,5	205	240
WL26090	89 – 90	210	245
WL26100	99 – 100	221	256



WL1N

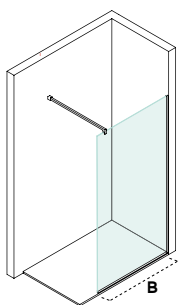



Características generales

-  1 Fijo con brazo a pared
-  Espesor vidrio 8 mm
-  Tratamiento antical a dos caras
-  Impresión tipo 2,3,4,8,17,19 opción A
-  Altura mampara 1950
-  Perfilera y herrajes en negro
-  Mampara en Stock, servicio inmediato

8 mm



Referencia	Rango Instalación B	Vidrio Transparente	Vidrio decorado
			
WL1N8070	67,5 – 68,5	259	294
WL1N8075	72,5 – 73,5	265	300
WL1N8080	77,5 – 78,5	272	307
WL1N8085	82,5 – 83,5	278	313
WL1N8090	89 – 90	289	324
WL1N8100	99 – 100	302	342
WL1N8110	109 – 110	316	356
WL1N8120	119 – 120	328	368

BLACK LINE
Perfilera y herrajes acabados negro





WL1NJ

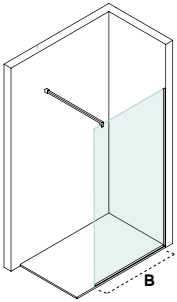

Características generales

- 1 Fijo con brazo a pared
- 8mm Espesor vidrio 8 mm
- X2 Tratamiento antical a dos caras
- 61 Impresión digital tipo 61 incluida.
- 1950mm Altura mampara 1950
- N Perfilera y herrajes en negro
- EXPRESS Mampara en Stock, servicio inmediato

Referencia	Rango Instalación B	Decorado 61
		61 BLACK LINE
WL1NJ8070	67,5 – 68,5	340
WL1NJ8075	72,5 – 73,5	346
WL1NJ8080	77,5 – 78,5	352
WL1NJ8085	82,5 – 83,5	358
WL1NJ8090	89 – 90	361
WL1NJ8100	99 – 100	384
WL1NJ8110	109 – 110	405
WL1NJ8120	119 – 120	419
WL1NJ8130	129 – 130	522
WL1NJ8140	139 – 140	541



61 Impresión digital tipo 61





WL2S

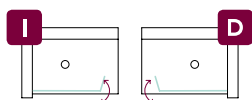
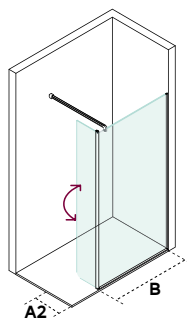

Referencia	Rango Instalación B+A2	Vidrio Transparente	Vidrio Decorado
		BRILLO	BRILLO
WL2S07025	92,5 – 94	321	376
WL2S08025	102,5 – 104	330	385
WL2S09025	112,5 – 114	341	396
WL2S10025	122,5 – 124	354	409
WL2S07040	107,5 – 709	329	384
WL2S08040	117,5 – 119	338	393
WL2S09040	127,5 – 129	349	404
WL2S10040	137,5 – 139	362	417

Características generales

- 1 Fijo con brazo a pared y aleta abatible
- Espesor vidrio 6 mm
- Tratamiento antical a dos caras
- Impresión tipo 2,3,4,8,17,19 opción A
- Altura mampara 1950
- Mampara en Stock, servicio inmediato



WL2SN

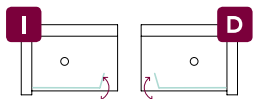
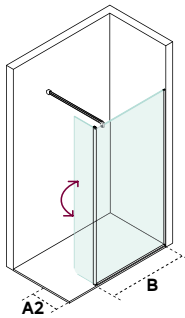

Referencia	Rango Instalación B+A2	Vidrio Transparente	Vidrio decorado
		BLACK LINE	BLACK LINE
WL2SN07025	92,5 – 94	369	433
WL2SN08025	102,5 – 104	380	443
WL2SN09025	112,5 – 114	392	455
WL2SN10025	122,5 – 124	407	470
WL2SN07040	107,5 – 709	379	442
WL2SN08040	117,5 – 119	389	452
WL2SN09040	127,5 – 129	401	464
WL2SN10040	137,5 – 139	416	480

Características generales

- 1 Fijo con brazo a pared y aleta abatible
- Espesor vidrio 6 mm
- Tratamiento antical a dos caras
- Impresión tipo 2,3,4,8,17,19 opción A
- Altura mampara 1950
- Perfilera y herrajes en negro



MAMPARAS A MEDIDA

Correderas

Solid
Pag:60



Side
Pag:68



Moon
Pag:76



Suite
Pag:84



Pass
Pag:94



Pag:112

Pag:118

Pag:118

Dune
Pag:100



Forum
Pag:108



Nexus
Pag:118



Infiniti
Pag:126



Rolling
Pag:132

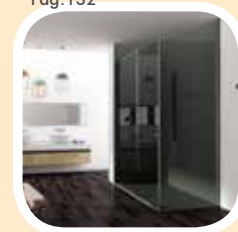

Batientes

Star
Pag:144



Handi
Pag:160



Flex
Pag:164



Nova
Pag:180



Open
Pag:198



Fijas

Nature
Pag: 216



Combi
Pag:138

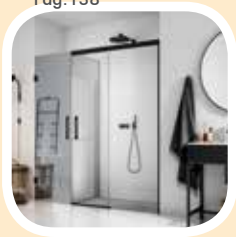

Quadro
Pag:204



		B BRILLO	SOLID
		B BRILLO	SIDE
		B BRILLO	MOON
		B BRILLO	STAR
		B BRILLO	WALL
	BLACK LINE	B BRILLO	SOLID
		B BRILLO	SIDE
	BLACK LINE	B BRILLO	MOON
		B BRILLO	SUITE
		B BRILLO	PASS
M MATEADO		B BRILLO	DUNE
M MATEADO		B BRILLO	FORUM
M MATEADO	BLACK LINE	B BRILLO	NEXUS
		B BRILLO	INFINITI
		B BRILLO	ROLLING
	BLACK LINE	B BRILLO	COMBI
	BLACK LINE	B BRILLO	STAR
		B BRILLO	HANDI
		B BRILLO	FLEX
	BLACK LINE	B BRILLO	NOVA
		B BRILLO	OPEN
	BLACK LINE	B BRILLO	QUADRO
	BLACK LINE	B BRILLO	NATURE
M MATEADO			STYLE
M MATEADO	BLACK LINE		NEXUS
		B BRILLO	TECHNICAL
		B BRILLO	ROLLING
M MATEADO			INVISIBLE
M MATEADO	BLACK LINE		FRAME
M MATEADO			CASSONETTO
M MATEADO	BLACK LINE		CLICK
M MATEADO	BLACK LINE	B BRILLO	PACK
C COBRE	BLACK LINE	B BRILLO	HIDRA
			DATOS TÉCNICOS
			DECORADOS

MAMPARAS A MEDIDA

SOLID

SOLID



• Ruedas superiores regulables



• Ruedas inferiores con liberador .



• Perfil a pared con imán y expansión de 20 mm



• Tirador metálico



• Esquinero superior

- B** BRILLO
- B** BRILLO
- B** BRILLO
- B** BRILLO
- B** BRILLO
- BLACK LINE** **B** BRILLO
- B** BRILLO
- B** BRILLO
- BLACK LINE** **B** BRILLO
- B** BRILLO
- B** BRILLO
- M** MATEADO **B** BRILLO
- M** MATEADO **B** BRILLO
- M** MATEADO **BLACK LINE** **B** BRILLO
- B** BRILLO
- B** BRILLO
- BLACK LINE** **B** BRILLO
- BLACK LINE** **B** BRILLO
- B** BRILLO
- B** BRILLO
- BLACK LINE** **B** BRILLO
- B** BRILLO
- BLACK LINE** **B** BRILLO
- BLACK LINE** **B** BRILLO
- M** MATEADO
- M** MATEADO **BLACK LINE**
- B** BRILLO
- B** BRILLO
- M** MATEADO
- M** MATEADO **BLACK LINE**
- M** MATEADO
- M** MATEADO **BLACK LINE**
- M** MATEADO **BLACK LINE** **B** BRILLO
- C** COBRE **BLACK LINE** **B** BRILLO

- SOLID
- SIDE
- MOON
- STAR
- WALL
- SOLID
- SIDE
- MOON
- SUITE
- PASS
- DUNE
- FORUM
- NEXUS
- INFINITI
- ROLLING
- COMBI
- STAR
- HANDI
- FLEX
- NOVA
- OPEN
- QUADRO
- NATURE
- STYLE
- NEXUS
- TECHNICAL
- ROLLING
- INVISIBLE
- FRAME
- CASSONETTO
- CLICK
- PACK
- HIDRA
- DATOS TÉCNICOS
- DECORADOS





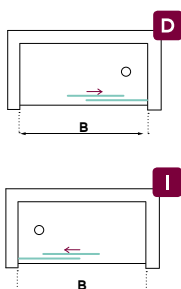
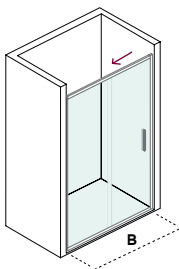

SOLID





SL2





Características

-  Fijo y puerta corredera
-  Espesor vidrio 6mm
-  Tratamiento antical a dos caras
-  Impresión digital, consultar pag:274
-  Altura 1950. Máxima hasta 2200mm
-  Ruedas con ajuste vertical
-  Cierre magnético
-  Mampara reversible en G0
-  Ancho máximo de la puerta 855 mm

Rango de medida B	G0 Transparente	G1 Mate, Extraclaro, Gris, Bronce	G2 Espejo, Negro
			
Hasta- 110	350	441	473
110 - 120	368	464	497
120 - 130	386	486	521
130 - 140	406	511	548
140 - 150	425	535	573
150 - 160	445	560	600
160 - 170	467	589	631
170 - 180	491	619	663
180 - 190	519	654	701
190 - 200	549	692	742

Opciones

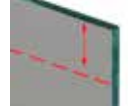
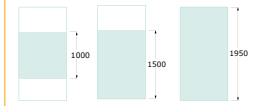
Cambio de tirador por uñero, +30	En bañera, h= 1500 al mismo precio	Incremento altura, +5% cada 5 cm	Impresión digital personalizada, ver pag:274
			 <p>Opción A Opción B Opción C</p>



SL3

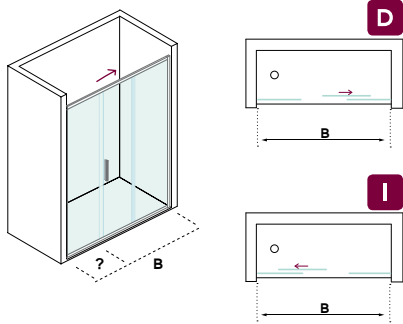

Rango de medida B	G0 Transparente	G1 Mate, Extraclaro, Gris, Bronce	G2 Espejo, Negro
	B BRILLO.....	B BRILLO.....	B BRILLO.....
Hasta- 140	450	567	608
140 - 150	465	586	628
150 - 160	480	605	648
160 - 170	498	627	672
170 - 180	515	649	695
180 - 190	533	671	719
190 - 200	550	693	743

Características

- 2 Fijo y 1puerta corredera
- Espesor vidrio 6mm
- Tratamiento antical a dos caras
- Impresión digital, consultar pag:274
- Altura 1950. Máxima hasta 2200mm
- Ruedas con ajuste vertical
- Mampara reversible en G0
- Ancho máximo de la puerta 855 mm

Opciones

Cambio de tirador por uñero, +30	En bañera,h= 1500 al mismo precio	Incremento altura, +5% cada 5 cm	Impresión digital personalizada, ver pag:274
			<p>Opcion A Opcion B Opcion C</p>



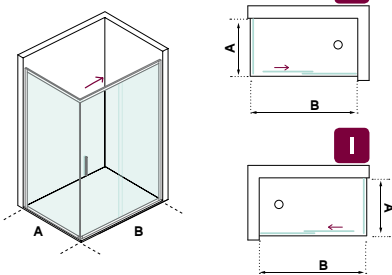

SL3A



Características

-  Fijo, puerta corredera y fijo lateral
-  Espesor vidrio 6mm
-  Tratamiento antical a dos caras
-  Impresión digital, consultar pag:274
-  Altura 1950. Máxima hasta 2200mm
-  Ruedas con ajuste vertical
-  Cierre magnético
-  Mampara reversible en G0
-  Ancho máximo de la puerta 855 mm

Rango de medida A + B	G0 Transparente	G1 Mate, Extraclaro, Gris, Bronce	G2 Espejo, Negro
	 BRILLO	 BRILLO	 BRILLO
Hasta- 180	531	669	717
180 - 190	541	682	731
190 - 200	553	696	746
200 - 210	574	723	775
210 - 220	584	736	788
220 - 230	616	776	832
230 - 240	639	805	862
240 - 250	661	833	893
250 - 260	684	862	923
260 - 270	708	891	955
270 - 280	730	920	986
280 - 290	746	940	1007
290 - 300	764	962	1031

Opciones

Cambio de tirador por uñero, +30	En bañera, h= 1500 al mismo precio	Incremento altura, +5% cada 5 cm	Impresión digital personalizada, ver pag:274
			



SL4

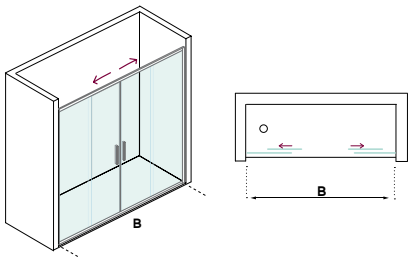

Características

- 2 Fijos, y 2 puertas correderas
- Espesor vidrio 6mm
- Tratamiento antical a dos caras
- Impresión digital, consultar pag:274
- Altura 1950. Máxima hasta 2200mm
- Ruedas con ajuste vertical
- Cierre magnético
- Mampara reversible en G0
- Ancho máximo de la puerta 855 mm

Rango de medida B	G0 Transparente	G1 Mate, Extraclaro, Gris, Bronce	G2 Espejo, Negro
Hasta- 140	495	624	668
140 - 150	511	644	690
150 - 160	528	665	712
160 - 170	548	690	739
170 - 180	566	713	764
180 - 190	586	739	791
190 - 200	605	762	817

Opciones

Cambio de tirador por uñero, +60	En bañera, h= 1500 al mismo precio	Incremento altura, +5% cada 5 cm	Impresión digital personalizada, ver pag:274

SOLID

SOLID



SL4A

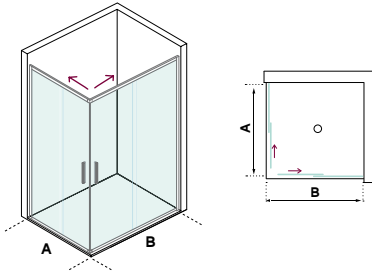

Características

- 2 Fijos +2 puertas correderas
- Espesor vidrio 6mm
- Tratamiento antical a dos caras
- Impresión digital, consultar pag:274
- Altura 1950. Máxima hasta 2200mm
- Ruedas con ajuste vertical
- Cierre magnético
- Mampara reversible en G0
- Ancho máximo de la puerta 600 mm

Rango de medida A + B	G0 Transparente	G1 Mate, Extraclaro, Gris, Bronce	G2 Espejo, Negro
Hasta- 150	512	645	691
150 - 160	528	665	712
160 - 170	543	685	734
170 - 180	559	704	755
180 - 190	575	724	776
190 - 200	591	744	797
200 - 210	606	764	819
210 - 220	622	784	840
220 - 230	638	804	861
230 - 240	654	824	882
240 - 250	669	843	904
250 - 260	685	863	925

Opciones

Cambio de tirador por uñero, +60	En bañera, h=1500 al mismo precio	Incremento altura, +5% cada 5 cm	Impresión digital personalizada, ver pag:274
			 Opcion A Opcion B Opcion C

SIDE



SIDE



• Ruedas regulables



• Tirador metálico



• Guiador metálico



• Vierteaguas y remates metálicos



• Esquinero superior en ABS

- B** BRILLO
- B** BRILLO
- B** BRILLO
- B** BRILLO
- BLACK LINE** **B** BRILLO
- B** BRILLO
- B** BRILLO
- BLACK LINE** **B** BRILLO
- B** BRILLO
- B** BRILLO
- M** MATEADO **B** BRILLO
- M** MATEADO **B** BRILLO
- M** MATEADO **BLACK LINE** **B** BRILLO
- B** BRILLO
- B** BRILLO
- BLACK LINE** **B** BRILLO
- BLACK LINE** **B** BRILLO
- B** BRILLO
- B** BRILLO
- BLACK LINE** **B** BRILLO
- B** BRILLO
- BLACK LINE** **B** BRILLO
- BLACK LINE** **B** BRILLO
- M** MATEADO
- M** MATEADO **BLACK LINE**
- B** BRILLO
- B** BRILLO
- M** MATEADO
- M** MATEADO **BLACK LINE**
- M** MATEADO
- M** MATEADO **BLACK LINE**
- M** MATEADO **BLACK LINE** **B** BRILLO
- C** COBRE **BLACK LINE** **B** BRILLO

- SOLID
- SIDE
- MOON
- STAR
- WALL
- SOLID
- SIDE
- MOON
- SUITE
- PASS
- DUNE
- FORUM
- NEXUS
- INFINITI
- ROLLING
- COMBI
- STAR
- HANDI
- FLEX
- NOVA
- OPEN
- QUADRO
- NATURE
- STYLE
- NEXUS
- TECHNICAL
- ROLLING
- INVISIBLE
- FRAME
- CASSONETTO
- CLICK
- PACK
- HIDRA
- DATOS TÉCNICOS
- DECORADOS

SIDE

SIDE



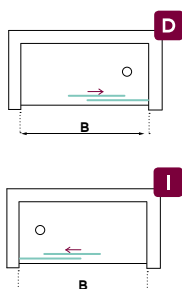
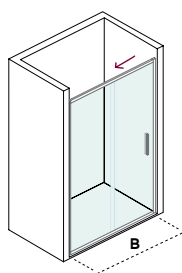

SIDE

SD2





Características

-  1 Fijo y 1 puerta corredera
-  Espesor vidrio 6mm
-  Tratamiento antical a dos caras
-  Impresión digital, consultar pag:274
-  Altura 1950. Máxima hasta 2200mm
-  Ruedas con ajuste vertical
-  Cierre magnético
-  Ancho máximo de la puerta 855 mm

Rango de medida B	G0 Transparente	G1 Mate, Extraclaro, Gris, Bronce	G2 Espejo, Negro
			
Hasta- 110	418	527	565
110 - 120	437	550	589
120 - 130	455	573	614
130 - 140	473	596	638
140 - 150	491	618	663
150 - 160	509	641	687
160 - 170	527	664	711
170 - 180	545	687	736
180 - 190	563	709	760
190 - 200	581	732	785

Opciones

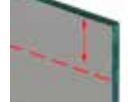
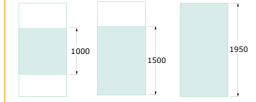
Cambio de tirador por uñero, +30	En bañera, h= 1500 al mismo precio	Incremento altura, +5% cada 5 cm	Impresión digital personalizada, ver pag:274
			



SIDE

SD2V

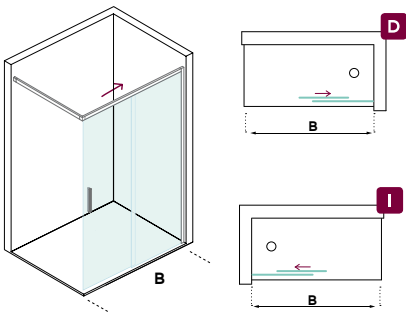

Rango de medida B	G0 Transparente	G1 Mate, Extraclaro, Gris, Bronce	G2 Espejo, Negro
	B BRILLO	B BRILLO	B BRILLO
Hasta- 100	387	488	523
100 - 110	406	511	547
110 - 120	424	534	572
120 - 130	442	557	596
130 - 140	460	579	621

Características

- 1 Fijo y 1 puerta corredera
- 6 mm Espesor vidrio 6mm
- X2 Tratamiento antical a dos caras
- Impresión digital Impresión digital pag:274
- 1950mm Altura 1950. Máxima hasta 2200
- ↕ Ruedas con ajuste vertical
- 500 mm Ancho máximo de la puerta 500 mm

Opciones			
Cambio de tirador por uñero, +30	En bañera, h= 1500 al mismo precio	Incremento altura, +5% cada 5 cm	Impresión digital personalizada, ver pag:274

SIDE







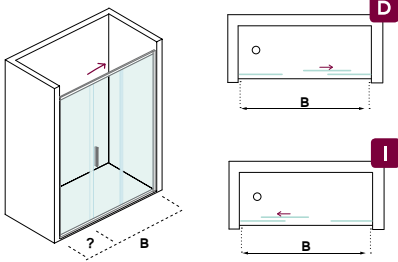

SIDE

SD3



Rango de medida B	G0 Transparente	G1 Mate, Extraclaro, Gris, Bronce	G2 Espejo.Negro
	B BRILLO	B BRILLO	B BRILLO
Hasta- 140	534	673	722
140 - 150	551	695	744
150 - 160	568	716	767
160 - 170	586	738	791
170 - 180	604	761	815
180 - 190	620	781	836
190 - 200	636	802	859

Características

-  2 Fijos y 1 puerta central corredera
-  Espesor vidrio 6mm
-  Tratamiento antical a dos caras
-  Impresión digital, consultar pag:274
-  Altura 1950. Máxima hasta 2200mm
-  Ruedas con ajuste vertical
-  Ancho máximo de la puerta 855 mm

Opciones

Cambio de tirador por uñero, +30	En bañera,h= 1500 al mismo precio	Incremento altura, +5% cada 5 cm	Impresión digital personalizada,ver pag:274
			 <p>Opción A Opción B Opción C</p>



SIDE

SD4

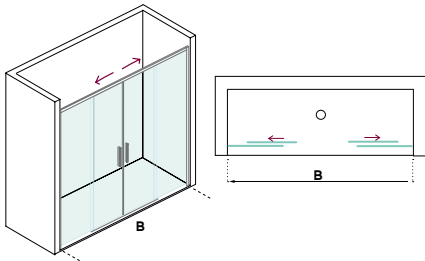

Rango de medida B	G0 Transparente	G1 Mate, Extraclaro, Gris, Bronce	G2 Espejo, Negro
	B BRILLO	B BRILLO	B BRILLO
Hasta- 140	588	741	794
140 - 150	607	765	819
150 - 160	625	787	843
160 - 170	645	812	870
170 - 180	665	837	897
180 - 190	681	859	920
190 - 200	701	884	947

Características

- 2 Fijos y 2 puertas correderas
- Espesor vidrio 6mm
- Tratamiento antical a dos caras
- Impresión digital, consultar pag:274
- Altura 1950. Máxima hasta 2200mm
- Ruedas con ajuste vertical
- Cierre magnético
- Ancho máximo de la puerta 600mm

Opciones

Cambio de tirador por uñero, +60	En bañera, h= 1500 al mismo precio	Incremento altura, +5% cada 5 cm	Impresión digital personalizada, ver pag:274

SIDE



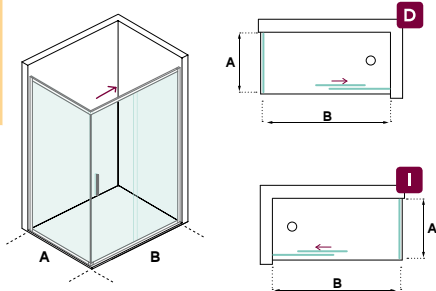

SIDE

SD3A



Características

-  2 Fijos y 1 puerta corredera
-  Espesor vidrio 6mm
-  Tratamiento antical a dos caras
-  Impresión digital, consultar pag:274
-  Altura 1950. Máxima hasta 2200mm
-  Ruedas con ajuste vertical
-  Cierre magnético
-  Ancho máximo de la puerta 855 mm

Rango de medida A+B	G0 Transparente	G1 Mate, Extraclaro, Gris, Bronce	G2 Espejo, Negro
			
Hasta- 180	581	732	784
180 - 190	598	754	808
190 - 200	616	776	832
200 - 210	634	799	857
210 - 220	654	824	883
220 - 230	671	845	905
230 - 240	688	867	929
240 - 250	706	889	952
250 - 260	722	910	975
260 - 270	737	929	996
270 - 280	757	954	1022
280 - 290	777	979	1048
290 - 300	796	1003	1075

Opciones

Cambio de tirador por uñero, +30	En bañera, h= 1500 al mismo precio	Incremento altura, +5% cada 5 cm	Impresión digital personalizada, ver pag:274
			



SIDE

SD4A

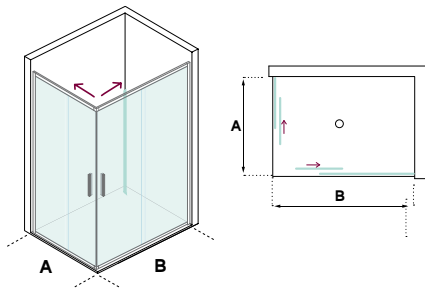

Rango de medida A+B	G0 Transparente	G1 Mate, Extraclaro, Gris, Bronce	G2 Espejo, Negro
	B BRILLO	B BRILLO	B BRILLO
Hasta- 150	534	672	720
150 - 160	549	692	741
160 - 170	564	711	762
170 - 180	582	733	786
180 - 190	597	753	806
190 - 200	613	772	827
200 - 210	628	792	848
210 - 220	647	815	873
220 - 230	664	837	897
230 - 240	680	857	918
240 - 250	695	876	939
250 - 260	711	895	959

Características

-  2 Fijos y 2 puertas correderas
-  Espesor vidrio 6mm
-  Tratamiento antical a dos caras
-  Impresión digital, consultar pag:274
-  Altura 1950. Máxima hasta 2200mm
-  Ruedas con ajuste vertical
-  Cierre magnético
-  Ancho máximo de la puerta 600 mm

Opciones

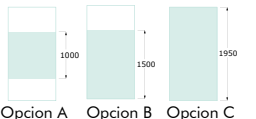
Cambio de tirador por uñero, +60	En bañera, h= 1500 al mismo precio	Incremento altura, +5% cada 5 cm	Impresión digital personalizada, ver pag:274
			

MOON

MOON



• Ruedas regulables



• Tirador metálico.



• Guiador metálico



• Vierteaguas y remates metálicos



• Cierre magnético a pared

- B BRILLO
- B BRILLO
- B BRILLO
- B BRILLO
- B BRILLO
- BLACK LINE B BRILLO
- B BRILLO
- B BRILLO
- BLACK LINE B BRILLO
- B BRILLO
- B BRILLO
- M MATEADO B BRILLO
- M MATEADO B BRILLO
- M MATEADO BLACK LINE B BRILLO
- B BRILLO
- B BRILLO
- BLACK LINE B BRILLO
- BLACK LINE B BRILLO
- B BRILLO
- B BRILLO
- BLACK LINE B BRILLO
- B BRILLO
- BLACK LINE B BRILLO
- BLACK LINE B BRILLO
- M MATEADO
- M MATEADO BLACK LINE
- B BRILLO
- B BRILLO
- M MATEADO
- M MATEADO BLACK LINE
- M MATEADO BLACK LINE
- M MATEADO BLACK LINE B BRILLO
- M MATEADO BLACK LINE B BRILLO
- C COBRE BLACK LINE B BRILLO

- SOLID
- SIDE
- MOON
- STAR
- WALL
- SOLID
- SIDE
- MOON
- SUITE
- PASS
- DUNE
- FORUM
- NEXUS
- INFINITI
- ROLLING
- COMBI
- STAR
- HANDI
- FLEX
- NOVA
- OPEN
- QUADRO
- NATURE
- STYLE
- NEXUS
- TECHNICAL
- ROLLING
- INVISIBLE
- FRAME
- CASSONETTO
- CLICK
- PACK
- HIDRA
- DATOS TÉCNICOS
- DECORADOS

NOON

MOON



MOON

MO2

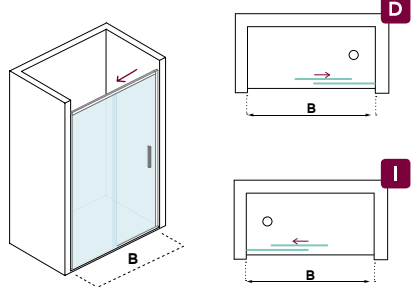

Características

- 1 Fijo y 1 puerta corredera
- Espesor vidrio 6mm
- Tratamiento antical a dos caras
- Impresión digital, consultar pag:274
- Altura 1950. Máxima hasta 2200mm
- Ruedas con ajuste vertical
- Cierre magnético
- Ancho máximo de la puerta 855 mm
- Mampara reversible en opción G0

Rango de medida B	G0 Transparente		G1 Mate, Extraclaro, Gris, Bronce		G2 Espejo, Negro	
	BRILLO	BLAK LINE	BRILLO	BLAK LINE	BRILLO	BLAK LINE
Hasta- 110	369	424	465	534	498	572
110 - 120	386	444	487	560	521	600
120 - 130	405	466	510	587	546	628
130 - 140	422	486	532	612	570	656
140 - 150	441	507	555	639	595	684
150 - 160	458	527	578	664	619	712
160 - 170	477	548	601	691	644	740
170 - 180	494	569	623	716	667	768
180 - 190	513	590	646	743	692	796
190 - 200	530	610	668	769	716	824

Opciones				
Cambio de tirador por uñero, +30	En bañera, h=1500 al mismo precio	Incremento altura, +5% cada 5 cm	Recortes especiales en el vidrio, +90	Impresión digital personalizada, ver pag:274



MO2V

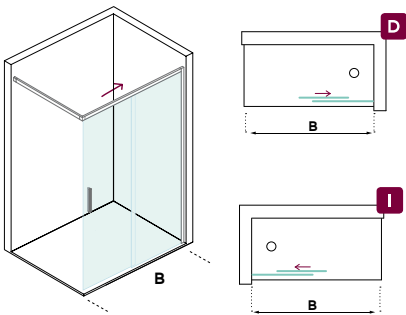

Rango de medida B	G0 Transparente		G1 Mate, Extraclaro, Gris, Bronce		G2 Espejo, Negro	
	B BRILLO	N BLAK LINE	B BRILLO	N BLAK LINE	B BRILLO	N BLAK LINE
Hasta- 100	347	398	437	502	468	538
100 - 110	362	417	456	525	489	562
110 - 120	381	438	480	552	514	591
120 - 130	399	459	503	578	539	619
130 - 140	417	480	526	605	563	648

Características

- 1 Fijo y 1 puerta corredera
- Espesor vidrio 6mm
- Tratamiento antical a dos caras
- Impresión digital pag:274
- Altura 1950. Máxima hasta 2200
- Ruedas con ajuste vertical
- Ancho máximo de la puerta 500 mm
- Mampara reversible en opción G0

Opciones

Cambio de tirador por uñero, +30	En bañera, h=1500 al mismo precio	Incremento altura, +5% cada 5 cm	Recortes especiales en el vidrio, +90	Impresión digital personalizada, ver pag:274
				 Opcion A Opcion B Opcion C

MOON



MOON

MO3

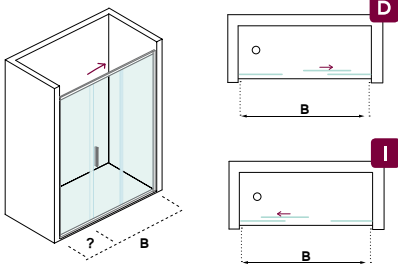





Rango de medida B	G0 Transparente		G1 Mate, Extraclaro, Gris, Bronce		G2 Espejo, Negro	
	B BRILLO	N BLAK LINE	B BRILLO	N BLAK LINE	B BRILLO	N BLAK LINE
Hasta- 140	497	572	627	721	672	772
140 - 150	515	592	649	746	695	800
150 - 160	531	611	670	770	717	825
160 - 170	549	631	692	795	741	852
170 - 180	567	651	714	821	765	879
180 - 190	583	670	735	845	787	905
190 - 200	598	688	754	867	808	929

Características

-  2 Fijos y 1 puerta central corredera
-  Espesor vidrio 6mm
-  Tratamiento antical a dos caras
-  Impresión digital, consultar pag:274
-  Altura 1950. Máxima hasta 2200mm
-  Ruedas con ajuste vertical
-  Ancho máximo de la puerta 855 mm
-  Mampara reversible en opción G0

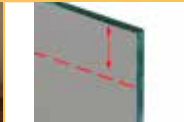
Opciones

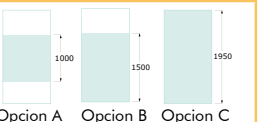
Cambio de tirador por uñero, +30	En bañera, h=1500 al mismo precio	Incremento altura, +5% cada 5 cm	Recortes especiales en el vidrio, +90	Impresión digital personalizada, ver pag:274
				
				Opción A Opción B Opción C



MO4

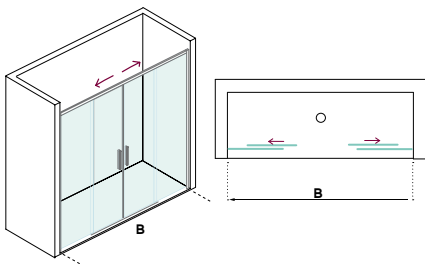

Características

- 2 Fijos y 2 puertas correderas
- Espesor vidrio 6mm
- Tratamiento antical a dos caras
- Impresión digital, consultar pag:274
- Altura 1950. Máxima hasta 2200mm
- Ruedas con ajuste vertical
- Cierre magnético
- Ancho máximo de la puerta 855 mm
- Mampara reversible en opción G0

Rango de medida B	G0 Transparente		G1 Mate, Extraclaro, Gris, Bronce		G2 Espejo, Negro	
	BRILLO	BLAK LINE	BRILLO	BLAK LINE	BRILLO	BLAK LINE
Hasta- 140	531	611	669	769	717	824
140 - 150	550	633	693	797	743	854
150 - 160	568	653	716	823	767	882
160 - 170	586	674	738	849	791	910
170 - 180	605	696	762	877	817	939
180 - 190	624	718	786	904	842	969
190 - 200	639	735	805	926	863	992

Opciones

Cambio de tirador por uñero, +60	En bañera, h=1500 al mismo precio	Incremento altura, +5% cada 5 cm	Recortes especiales en el vidrio, +90	Impresión digital personalizada, ver pag:274

MOON



MOON

MO3A

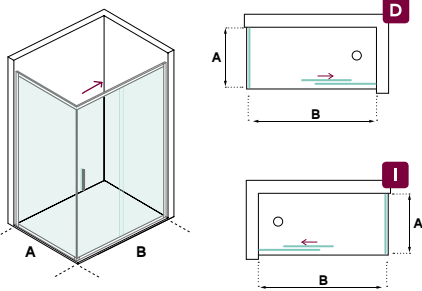

Características

- 2 Fijos y 1 puerta corredera
- Espesor vidrio 6mm
- Tratamiento antical a dos caras
- Impresión digital, consultar pag:274
- Altura 1950. Máxima hasta 2200mm
- Ruedas con ajuste vertical
- Cierre magnético
- Ancho máximo de la puerta 855 mm
- Mampara reversible en opción G0

Rango de medida A+B	G0 Transparente		G1 Mate, Extraclaro, Gris, Bronce		G2 Espejo, Negro	
	BRILLO	BLAK LINE	BRILLO	BLAK LINE	BRILLO	BLAK LINE
Hasta- 180	529	609	667	767	714	822
180 - 190	547	629	689	793	739	850
190 - 200	568	653	715	823	767	881
200 - 210	585	672	737	847	789	907
210 - 220	601	691	758	871	812	933
220 - 230	618	711	779	895	834	959
230 - 240	635	730	800	920	857	985
240 - 250	653	751	822	946	881	1013
250 - 260	670	770	844	970	904	1039
260 - 270	685	788	863	992	925	1063
270 - 280	704	810	887	1020	951	1093
280 - 290	725	834	913	1050	979	1125
290 - 300	744	856	938	1078	1005	1155

Opciones

Cambio de tirador por uñero, +30	En bañera, h=1500 al mismo precio	Incremento altura, +5% cada 5 cm	Recortes especiales en el vidrio, +90	Impresión digital personalizada, ver pag:274





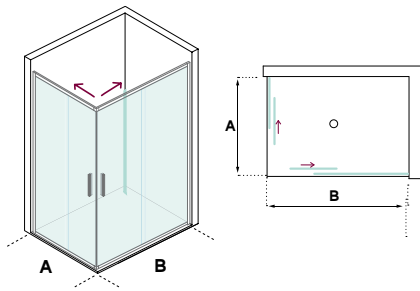



MO4A



Características

-  2 Fijos y 2 puertas correderas
-  Espesor vidrio 6mm
-  Tratamiento antical a dos caras
-  Impresión digital, consultar pag:274
-  Altura 1950. Máxima hasta 2200mm
-  Ruedas con ajuste vertical
-  Cierre magnético
-  Ancho máximo de la puerta 600 mm

Rango de medida A+B	G0 Transparente		G1 Mate, Extraclaro, Gris, Bronce		G2 Espejo, Negro	
	 BRILLO	 BLAK LINE	 BRILLO	 BLAK LINE	 BRILLO	 BLAK LINE
Hasta- 150	512	589	645	742	691	795
150 - 160	528	607	665	765	712	819
160 - 170	543	625	685	787	734	844
170 - 180	559	643	704	810	755	868
180 - 190	575	661	724	833	776	892
190 - 200	591	679	744	856	797	917
200 - 210	606	697	764	879	819	941
210 - 220	622	715	784	901	840	966
220 - 230	638	734	804	924	861	990
230 - 240	654	752	824	947	882	1015
240 - 250	669	770	843	970	904	1039
250 - 260	685	788	863	993	925	1064

Opciones

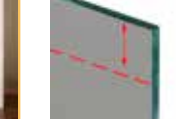
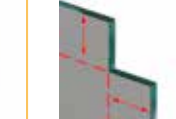
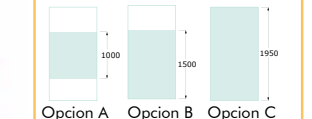
Cambio de tirador por uñero, +60	En bañera, h=1500 al mismo precio	Incremento altura, +5% cada 5 cm	Recortes especiales en el vidrio, +90	Impresión digital personalizada, ver pag:274
				

SUITE

SUITE



• Guía de aluminio alto brillo

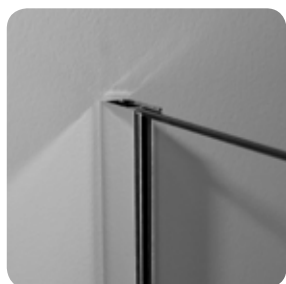

• Perfil a pared de aluminio acabado alto brillo.

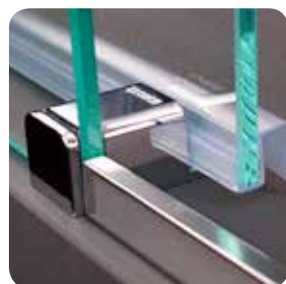

• Guiador en ABS cromado



• Cierre magnético a pared.



• Pomo metálico



• Freno con ajuste de posición.

- BRILLO
- BRILLO
- BRILLO
- BRILLO
- BLACK LINE
- BRILLO
- BRILLO
- BLACK LINE
- BRILLO
- BRILLO
- M MATEADO
- BRILLO
- M MATEADO
- BRILLO
- M MATEADO
- BLACK LINE
- BRILLO
- BRILLO
- BRILLO
- BLACK LINE
- BRILLO
- BLACK LINE
- BRILLO
- BRILLO
- BLACK LINE
- BRILLO
- BLACK LINE
- BRILLO
- M MATEADO
- M MATEADO
- BLACK LINE
- BRILLO
- BRILLO
- M MATEADO
- M MATEADO
- BLACK LINE
- M MATEADO
- BLACK LINE
- BRILLO
- M MATEADO
- BLACK LINE
- BRILLO
- C COBRE
- BLACK LINE
- BRILLO

- SOLID
- SIDE
- MOON
- STAR
- WALL
- SOLID
- SIDE
- MOON
- SUITE
- PASS
- DUNE
- FORUM
- NEXUS
- INFINITI
- ROLLING
- COMBI
- STAR
- HANDI
- FLEX
- NOVA
- OPEN
- QUADRO
- NATURE
- STYLE
- NEXUS
- TECHNICAL
- ROLLING
- INVISIBLE
- FRAME
- CASSONETTO
- CLICK
- PACK
- HIDRA
- DATOS TÉCNICOS
- DECORADOS

SUITE

SUITE



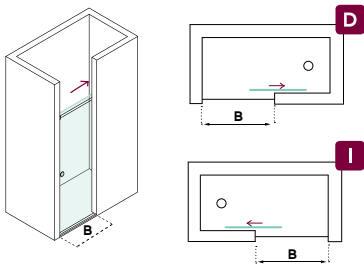

SUITE

SUI





Características

-  Puerta corredera
-  Espesor vidrio 6mm
-  Tratamiento antical a dos caras
-  Impresión digital, consultar pag:274
-  Altura 1950. Máxima hasta 2200mm
-  Ruedas con ajuste vertical
-  Cierre magnético
-  Ancho máximo de la puerta 900 mm

Rango de medida B	G0 Transparente	G1 Mate, Extraclaro, Gris, Bronce	G2 Espejo, Negro
			
Hasta- 70	374	430	505
70 - 90	401	461	541

Opciones

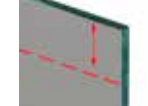
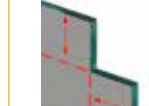
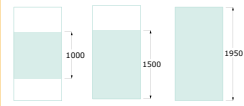
Cambio de tirador por uñero, +30	En bañera, h=1500 al mismo precio	Incremento altura, +5% cada 5 cm	Recortes especiales en el vidrio, +90	Impresión digital personalizada, ver pag:274
				



SU2

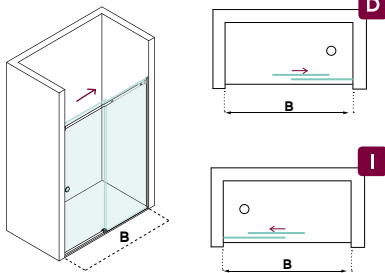



Características

-  1 Fijo y 1 puerta corredera
-  Espesor vidrio 6mm
-  Tratamiento antical a dos caras
-  Impresión digital, consultar pag:274
-  Altura 1950. Máxima hasta 2200mm
-  Ruedas con ajuste vertical
-  Cierre magnético
-  Ancho máximo de la puerta 900mm

Rango de medida B	G0 Transparente	G1 Mate, Extraclaro, Gris, Bronce	G2 Espejo, Negro
	B BRILLO	B BRILLO	B BRILLO
Hasta 100	457	526	617
100 - 110	474	545	640
110 - 120	486	559	656
120 - 130	517	595	698
130 - 140	529	608	714
140 - 150	539	620	728
150 - 160	556	639	751
160 - 170	568	653	767
170 - 180	580	667	783
180 - 190	593	682	801
190 - 200	605	696	817

Opciones

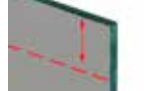
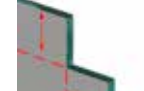
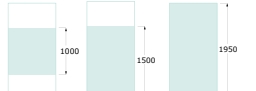
Cambio de tirador por uñero, +30	En bañera, h=1500 al mismo precio	Incremento altura, +5% cada 5 cm	Recortes especiales en el vidrio, +90	Impresión digital personalizada, ver pag:274
				 <p>Opcion A Opcion B Opcion C</p>

SUITE







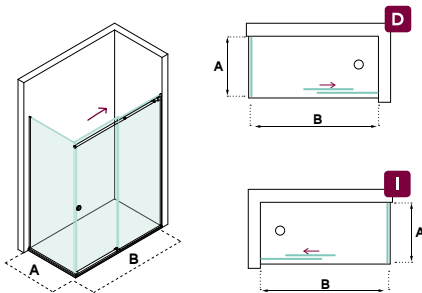

SUITE

SU3A





Rango de medida A + B	G0 Transparente	G1 Mate, Extraclaro, Gris, Bronce	G2 Espejo, Negro
		B BRILLO	B BRILLO
Hasta - 190	666	766	899
190 - 220	706	812	953
220 - 250	746	858	1008
250 - 280	787	905	1062
280 - 300	812	934	1097

Características

-  2 Fijos y 1 puerta corredera
-  Espesor vidrio 6mm
-  Tratamiento antical a dos caras
-  Impresión digital, consultar pag:274
-  Altura 1950. Máxima hasta 2200mm
-  Ruedas con ajuste vertical
-  Ancho máximo de la puerta 900 mm

Opciones

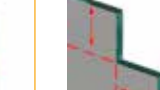
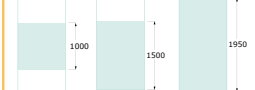
Cambio de tirador por uñero, +30	En bañera, h=1500 al mismo precio	Incremento altura, +5% cada 5 cm	Recortes especiales en el vidrio, +90	Impresión digital personalizada, ver pag:274
				 <p>Opción A Opción B Opción C</p>



SU3AM

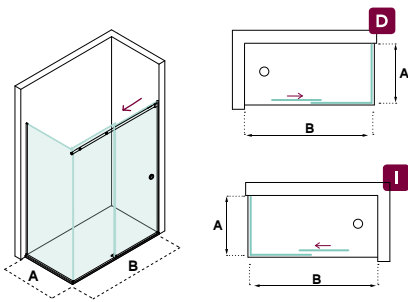

Rango de medida A+B	G0 Transparente	G1 Mate, Extraclaro, Gris, Bronce	G2 Espejo, Negro
	BRILLO	BRILLO	BRILLO
Hasta - 190	710	817	959
190 - 220	751	863	1013
220 - 250	791	910	1068
250 - 280	832	957	1124
280 - 300	855	983	1154

Características

- 2 Fijos y 1 puerta corredera
- Espesor vidrio 6mm
- Tratamiento antical a dos caras
- Impresión digital, consultar pag:274
- Altura 1950. Máxima hasta 2200mm
- Ruedas con ajuste vertical
- Cierre magnético
- Ancho máximo de la puerta 900 mm

Opciones

Cambio de tirador por uñero, +30	En bañera, h=1500 al mismo precio	Incremento altura, +5% cada 5 cm	Recortes especiales en el vidrio, +90	Impresión digital personalizada, ver pag:274
				 Opcion A Opcion B Opcion C

SUITE



SUITE

SU3

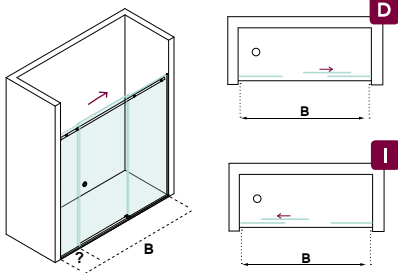

Rango de medida B	G0 Transparente	G1 Mate, Extraclaro, Gris, Bronce	G2 Espejo, Negro
		B BRILLO	B BRILLO
Hasta- 120	607	698	820
120 - 140	619	712	836
140 - 160	643	740	868
160 - 180	667	767	901
180 - 200	691	795	933

Características

-  2 Fijos y 1 puerta central corredera
-  Espesor vidrio 6mm
-  Tratamiento antical a dos caras
-  Impresión digital, consultar pag:274
-  Altura 1950. Máxima hasta 2200mm
-  Ruedas con ajuste vertical
-  Ancho máximo de la puerta 900 mm

Opciones

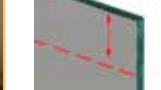
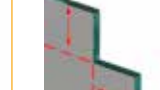
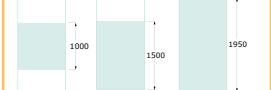
Cambio de tirador por uñero, +30	En bañera, h=1500 al mismo precio	Incremento altura, +5% cada 5 cm	Recortes especiales en el vidrio, +90	Impresión digital personalizada, ver pag:274
				



SU4

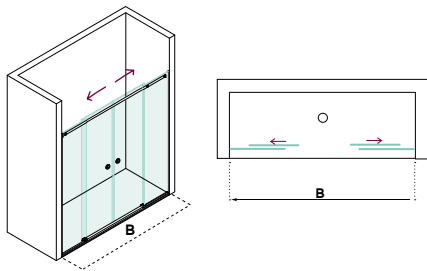

Rango de medida B	G0 Transparente	G1 Mate, Extraclaro, Gris, Bronce	G2 Espejo, Negro
	B BRILLO	B BRILLO	B BRILLO
Hasta- 120	662	762	894
120 - 140	674	776	910
140 - 160	698	803	943
160 - 180	727	836	982
180 - 200	751	864	1014

Características

- 2 Fijos y 2 puertas correderas
- Espesor vidrio 6mm
- Tratamiento antical a dos caras
- Impresión digital, consultar pag:274
- Altura 1950. Máxima hasta 2200mm
- Ruedas con ajuste vertical
- Cierre magnético
- Ancho máximo de la puerta 600 mm

Opciones

Cambio de tirador por uñero, +60	En bañera, h=1500 al mismo precio	Incremento altura, +5% cada 5 cm	Recortes especiales en el vidrio, +90	Impresión digital personalizada, ver pag:274
				<p>Opcion A Opcion B Opcion C</p>

SUITE

SUITE



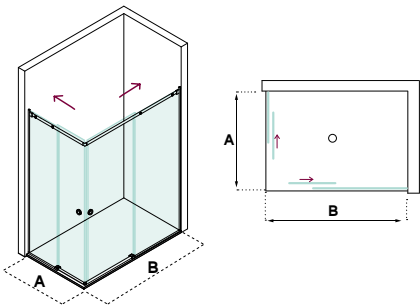

SU4A







Características

-  2 Fijos y 2 puertas corredera
-  Espesor vidrio 6mm
-  Tratamiento antical a dos caras
-  Impresión digital, consultar pag:274
-  Altura 1950. Máxima hasta 2200mm
-  Ruedas con ajuste vertical
-  Cierre magnético
-  Ancho máximo de la puerta 600mm

Rango de medida A+B	G0 Transparente	G1 Mate, Extraclaro, Gris, Bronce	G2 Espejo, Negro
			
Hasta- 150	699	804	943
150 - 170	727	837	982
170 - 190	756	869	1021
190 - 210	785	902	1059
210 - 230	799	919	1079
230 - 250	858	987	1158
250 - 270	887	1020	1197

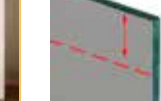
Opciones

Cambio de tirador por uñero, +60	En bañera, h=1500 al mismo precio	Incremento altura, +5% cada 5 cm	Recortes especiales en el vidrio, +90	Impresión digital personalizada, ver pag:274
				



SU3AR

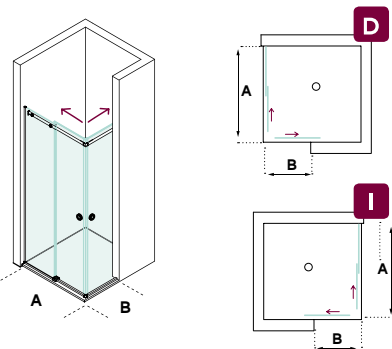

Características

- 1 Fijo y 2 puertas correderas
- Espesor vidrio 6mm
- Tratamiento antical a dos caras
- Impresión digital, consultar pag:274
- Altura 1950. Máxima hasta 2200mm
- Ruedas con ajuste vertical
- Cierre magnético
- Ancho máximo de la puerta 600 mm

Rango de medida A+B	G0 Transparente	G1 Mate, Extraclaro, Gris, Bronce	G2 Espejo, Negro
Hasta- 130	636	731	858
130 - 150	660	759	891
150 - 170	684	787	924
170 - 190	729	839	985
190 - 210	769	884	1038
210 - 230	793	912	1071
230 - 250	817	940	1103

Opciones

Cambio de tirador por uñero, +60	En bañera, h=1500 al mismo precio	Incremento altura, +5% cada 5 cm	Recortes especiales en el vidrio, +90	Impresión digital personalizada, ver pag:274
				 Opcion A Opcion B Opcion C

PASS

PASS



• Uñero metálico



• Tirador metálico



- B** BRILLO
- B** BRILLO
- B** BRILLO
- B** BRILLO
- BLACK LINE** **B** BRILLO
- B** BRILLO
- B** BRILLO
- BLACK LINE** **B** BRILLO
- B** BRILLO
- B** BRILLO
- M** MATEADO **B** BRILLO
- M** MATEADO **B** BRILLO
- M** MATEADO **BLACK LINE** **B** BRILLO
- B** BRILLO
- B** BRILLO
- BLACK LINE** **B** BRILLO
- BLACK LINE** **B** BRILLO
- B** BRILLO
- B** BRILLO
- BLACK LINE** **B** BRILLO
- B** BRILLO
- BLACK LINE** **B** BRILLO
- BLACK LINE** **B** BRILLO
- M** MATEADO
- M** MATEADO **BLACK LINE**
- B** BRILLO
- B** BRILLO
- M** MATEADO
- M** MATEADO **BLACK LINE**
- M** MATEADO
- M** MATEADO **BLACK LINE**
- M** MATEADO **BLACK LINE** **B** BRILLO
- C** COBRE **BLACK LINE** **B** BRILLO

- SOLID
- SIDE
- MOON
- STAR
- WALL
- SOLID
- SIDE
- MOON
- SUITE
- PASS
- DUNE
- FORUM
- NEXUS
- INFINITI
- ROLLING
- COMBI
- STAR
- HANDI
- FLEX
- NOVA
- OPEN
- QUADRO
- NATURE
- STYLE
- NEXUS
- TECHNICAL
- ROLLING
- INVISIBLE
- FRAME
- CASSONETTO
- CLICK
- PACK
- HIDRA
- DATOS TÉCNICOS
- DECORADOS

PASS

PASS



PASS

PS2T

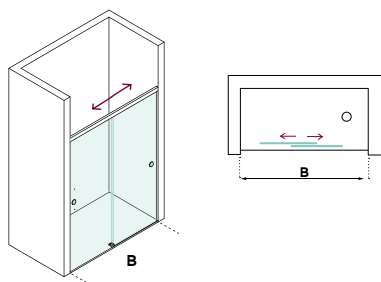

Rango de medida B	G0 Transparente	G1 Mate, Extraclaro, Gris, Bronce	G2 Espejo, Negro
	B BRILLO	B BRILLO	B BRILLO
Hasta 100	494	623	668
100 - 120	523	658	705
120 - 140	550	692	742
140 - 160	588	741	794

Características

-  2 Puertas correderas en doble sentido
-  Espesor vidrio 6mm
-  Tratamiento antical a dos caras
-  Impresión digital, consultar pag:274
-  Altura 1950. Máxima hasta 2200mm
-  Ruedas con ajuste vertical
-  Cierre magnético
-  Ancho máximo de la puerta 800 mm

Opciones

En bañera, h=1500 al mismo precio	Incremento altura, +5% cada 5 cm	Recortes especiales en el vidrio, +90	Impresión digital personalizada, ver pag:274
			 <p>Opcion A Opcion B Opcion C</p>



PS3AT

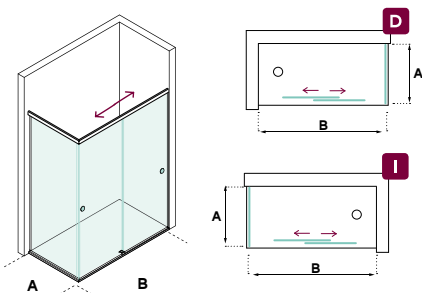

Rango de medida A + B	G0 Transparente	G1 Mate, Extraclaro, Gris, Bronce	G2 Espejo, Negro
	B BRILLO	B BRILLO	B BRILLO
Hasta 190	736	927	993
190 - 200	744	937	1004
200 - 210	764	962	1031
210 - 220	777	979	1049
220 - 230	791	996	1067

Características

- 2 Puertas correderas en doble sentido
- Espesor vidrio 6mm
- Tratamiento antical a dos caras
- Impresión digital, consultar pag:274
- Altura 1950. Máxima hasta 2200mm
- Ruedas con ajuste vertical
- Cierre magnético
- Ancho máximo de la puerta 800mm

Opciones

En bañera, h=1500 al mismo precio	Incremento altura, +5% cada 5 cm	Recortes especiales en el vidrio, +90	Impresión digital personalizada, ver pag:274
			 Opcion A Opcion B Opcion C

PASS

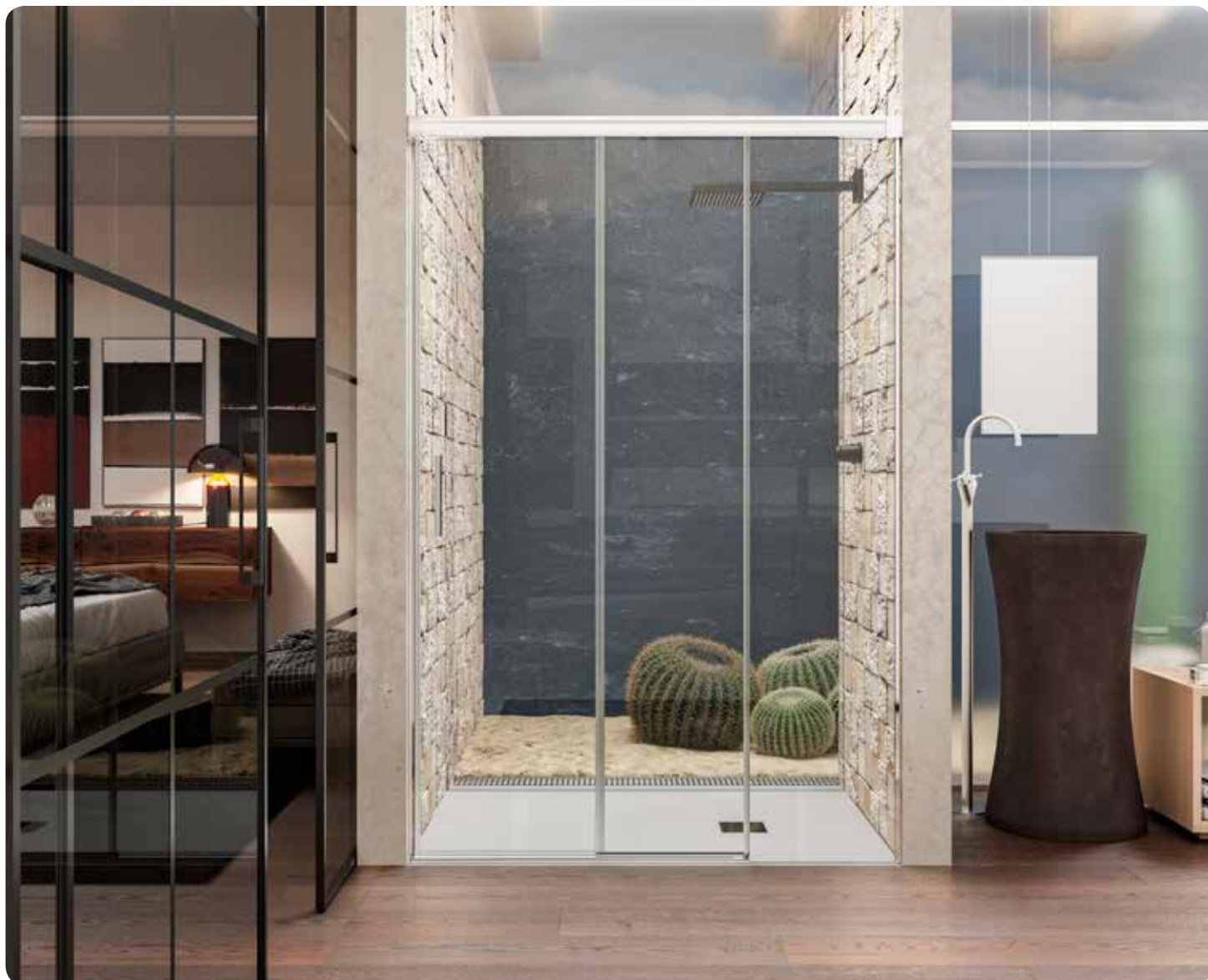



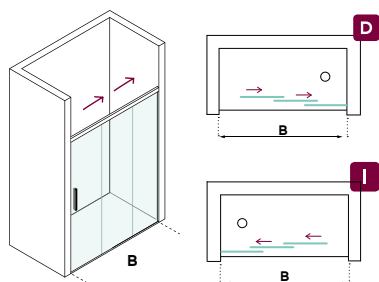

PASS

PS3T



Características

-  2 Puertas correderas doble mas 1 fijo
-  Espesor vidrio 6mm
-  Tratamiento antical a dos caras
-  Impresión digital, consultar pag:274
-  Altura 1950. Máxima hasta 2200mm
-  Ruedas con ajuste vertical
-  Cierre magnético
-  Ancho máximo de la puerta 500 mm

Rango de medida B	G0 Transparente	G1 Mate, Extraclaro, Gris, Bronce	G2 Espejo, Negro
			
Hasta 100	449	565	606
100 - 120	464	585	627
120 - 140	484	609	653

Opciones

En bañera, h=1500 al mismo precio	Incremento altura, +5% cada 5 cm	Recortes especiales en el vidrio, +90	Impresión digital personalizada, ver pag:274
			 <p>Opcion A Opcion B Opcion C</p>



PASS

PS4AT

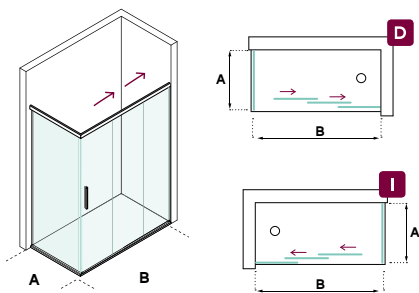

Rango de medida A + B	G0 Transparente	G1 Mate, Extraclaro, Gris, Bronce	G2 Espejo, Negro
Hasta 190	674	849	909
190 - 200	688	867	929
200 - 210	701	883	946
210 - 220	714	899	964
220 - 230	725	913	978

Características

- 2 Puertas correderas doble con 2 fijos
- Espesor vidrio 6mm
- Tratamiento antical a dos caras
- Impresión digital, consultar pag:274
- Altura 1950. Máxima hasta 2200mm
- Ruedas con ajuste vertical
- Cierre magnético
- Ancho máximo de la puerta 500mm

Opciones

En bañera, h=1500 al mismo precio	Incremento altura, +5% cada 5 cm	Recortes especiales en el vidrio, +90	Impresión digital personalizada, ver pag:274
			Opcion A Opcion B Opcion C

DUNE

DUNE



• Guía de acero inox.



• Perfil a pared de acero inox.



• Guiador acero inox



• Cierre magnético a pared.



• Pomo en acero inox.

	BRILLO	SOLID
	BRILLO	SIDE
	BRILLO	MOON
	BRILLO	STAR
	BLACK LINE	WALL
	BRILLO	SOLID
	BRILLO	SIDE
	BLACK LINE	MOON
	BRILLO	SUITE
	BRILLO	PASS
M MATEADO	BRILLO	DUNE
M MATEADO	BRILLO	FORUM
M MATEADO	BLACK LINE	NEXUS
	BRILLO	INFINITI
	BRILLO	ROLLING
	BLACK LINE	COMBI
	BLACK LINE	STAR
	BRILLO	HANDI
	BRILLO	FLEX
	BLACK LINE	NOVA
	BRILLO	OPEN
	BLACK LINE	QUADRO
	BLACK LINE	NATURE
M MATEADO		STYLE
M MATEADO	BLACK LINE	NEXUS
	BRILLO	TECHNICAL
	BRILLO	ROLLING
M MATEADO		INVISIBLE
M MATEADO	BLACK LINE	FRAME
M MATEADO	BLACK LINE	CASSONETTO
M MATEADO	BLACK LINE	CLICK
M MATEADO	BLACK LINE	PACK
C COBRE	BLACK LINE	HIDRA
	BRILLO	DATOS TÉCNICOS
		DECORADOS

DUNE

DUNE



DUNE

DN2

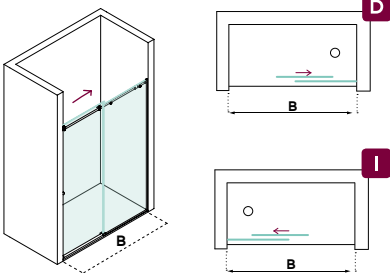



Rango de medida B	G0 Transparente		G1 Mate, Extraclaro, Gris, Bronce		G2 Espejo, Negro	
	B BRILLO	M MATE	B BRILLO	M MATE	B BRILLO	M MATE
Hasta - 120	615	676	689	758	738	812
120 - 140	671	738	751	826	805	885
140 - 160	698	768	782	860	838	922
160 - 180	742	816	831	914	890	979
180 - 200	785	863	879	967	942	1036

Características

-  1 Fijo y 1 puerta corredera
-  Espesor vidrio 8mm
-  Tratamiento antical a dos caras
-  Impresión digital, consultar pag:274
-  Altura 1950. Máxima hasta 2400mm
-  Ruedas con ajuste vertical
-  Cierre magnético
-  Ancho máximo de la puerta 900mm

Opciones

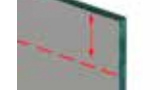
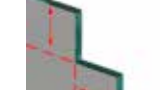
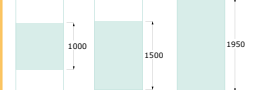
Cambio de pomo por tirador, +30	En bañera, h=1500 al mismo precio	Incremento altura, +5% cada 5 cm	Recortes especiales en el vidrio, +90	Impresión digital personalizada, ver pag:274
				
				Opción A Opción B Opción C



DN3

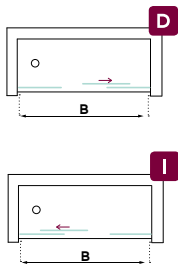
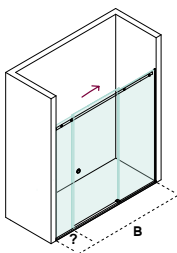

Rango de medida B	G0 Transparente		G1 Mate, Extraclaro, Gris, Bronce		G2 Espejo, Negro	
	B BRILLO	M MATE	B BRILLO	M MATE	B BRILLO	M MATE
Hasta - 160	771	849	864	950	926	1018
160 - 180	809	889	906	996	970	1067
180 - 200	844	928	945	1039	1012	1114
200 - 220	896	986	1004	1104	1075	1183
220 - 240	928	1021	1039	1143	1114	1225

Características

- 2 Fijos y 1 puerta corredera
- Espesor vidrio 8mm
- Tratamiento antical a dos caras
- Impresión digital, consultar pag:274
- Altura 1950. Máxima hasta 2400mm
- Ruedas con ajuste vertical
- Ancho máximo de la puerta 900mm

Opciones

Cambio de pomo por tirador, +30	En bañera, h= 1500 al mismo precio	Incremento altura, +5% cada 5 cm	Recortes especiales en el vidrio, +90	Impresión digital personalizada, ver pag:274

DUNE

DUNE





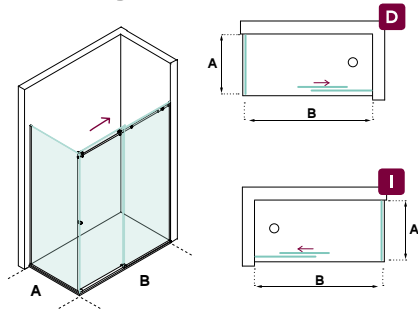



DN3A





Características

-  2 Fijos y 1 puerta corredera
-  Espesor vidrio 8mm
-  Tratamiento antical a dos caras
-  Impresión digital, consultar pag:274
-  Altura 1950. Máxima hasta 2400mm
-  Ruedas con ajuste vertical
-  Ancho máximo de la puerta 900mm

Rango de medida A+B	G0 Transparente		G1 Mate, Extraclaro, Gris, Bronce		G2 Espejo, Negro	
	 BRILLO	 MATE	 BRILLO	 MATE	 BRILLO	 MATE
Hasta - 160	805	886	902	992	966	1063
160 - 180	840	924	941	1035	1008	1109
180 - 200	879	967	984	1083	1055	1160
200 - 220	915	1006	1025	1127	1098	1208
220 - 240	958	1054	1073	1180	1149	1264
240 - 260	998	1098	1118	1230	1198	1317
260 - 280	1039	1143	1163	1280	1246	1371
280 - 300	1077	1184	1206	1326	1292	1421

Opciones

Cambio de pomo por tirador, +30	En bañera, h=1500 al mismo precio	Incremento altura, +5% cada 5 cm	Recortes especiales en el vidrio, +90	Impresión digital personalizada, ver pag:274
				
				Opción A Opción B Opción C



DN3AM

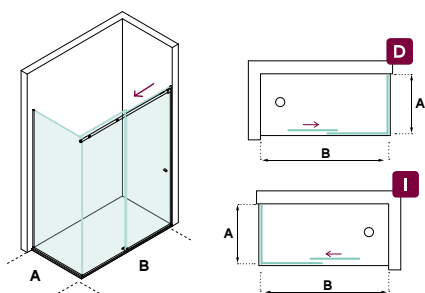

Características

- 2 Fijos y 1 puerta corredera
- Espesor vidrio 8mm
- Tratamiento antical a dos caras
- Impresión digital, consultar pag:274
- Altura 1950. Máxima hasta 2400mm
- Ruedas con ajuste vertical
- Cierre magnético
- Ancho máximo de la puerta 900mm

Rango de medida A+B	G0 Transparente		G1 Mate, Extraclaro, Gris, Bronce		G2 Espejo, Negro	
	B BRILLO	M MATE	B BRILLO	M MATE	B BRILLO	M MATE
Hasta - 160	858	944	961	1057	1029	1132
160 - 180	893	983	1000	1101	1072	1179
180 - 200	932	1026	1044	1149	1119	1231
200 - 220	969	1066	1085	1194	1163	1279
220 - 240	1012	1113	1134	1247	1215	1336
240 - 260	1053	1158	1179	1297	1263	1390
260 - 280	1094	1203	1225	1348	1313	1444
280 - 300	1132	1245	1268	1395	1359	1495

Opciones

Cambio de pomo por tirador, +30	En bañera, h=1500 al mismo precio	Incremento altura, +5% cada 5 cm	Recortes especiales en el vidrio, +90	Impresión digital personalizada, ver pag:274

DUNE

DUNE



DN4

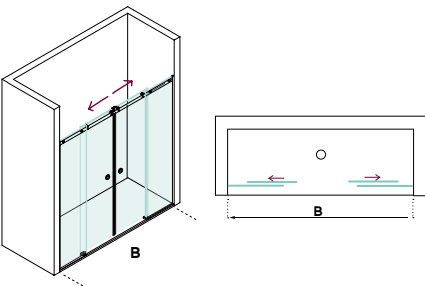



Rango de medida B	G0 Transparente		G1 Mate, Extraclaro, Gris, Bronce		G2 Espejo, Negro	
	B BRILLO	M MATE	B BRILLO	M MATE	B BRILLO	M MATE
Hasta - 120	876	963	981	1079	1051	1156
120 - 140	919	1011	1029	1132	1103	1213
140 - 160	965	1062	1081	1189	1158	1274
160 - 180	990	1089	1109	1219	1188	1307
180 - 200	1023	1125	1146	1260	1227	1350

Características

-  2 Fijos y 2 puertas corredera
-  Espesor vidrio 8mm
-  Tratamiento antical a dos caras
-  Impresión digital, consultar pag:274
-  Altura 1950. Máxima hasta 2400mm
-  Ruedas con ajuste vertical
-  Cierre magnético
-  Ancho máximo de la puerta 500mm

Opciones

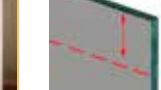
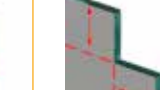
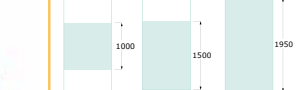
Cambio de pomo por tirador, +60	En bañera, h=1500 al mismo precio	Incremento altura, +5% cada 5 cm	Recortes especiales en el vidrio, +90	Impresión digital personalizada, ver pag:274
				
				Opción A Opción B Opción C



DN4U

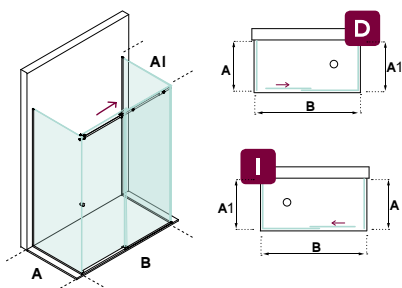

Rango de medida A+A1+B	G0 Transparente		G1 Mate, Extraclaro, Gris, Bronce		G2 Espejo, Negro	
	B BRILLO	M MATE	B BRILLO	M MATE	B BRILLO	M MATE
	Hasta - 260	1177	1294	1318	1450	1412
260 - 300	1231	1354	1379	1517	1477	1625
300 - 340	1329	1462	1489	1637	1595	1754
340 - 380	1425	1567	1596	1756	1710	1881

Características

- 3 Fijos y 1 puerta corredera
- Espesor vidrio 8mm
- Tratamiento antical a dos caras
- Impresión digital, consultar pag:274
- Altura 1950. Máxima hasta 2400mm
- Ruedas con ajuste vertical
- Ancho máximo de la puerta 900mm

Opciones

Cambio de pomo por tirador, +30	En bañera, h=1500 al mismo precio	Incremento altura, +5% cada 5 cm	Recortes especiales en el vidrio, +90	Impresión digital personalizada, ver pag:274

FORUM

FORUM



• Guía de acero inox.



• Perfil a pared de acero inox.



• Guiador acero inox



• Cierre magnético a pared.



• Tirador metálico.



• Soporte guía en acero.

- BRILLO
- BRILLO
- BRILLO
- BRILLO
- BLACK LINE
- BRILLO
- BRILLO
- BLACK LINE
- BRILLO
- BRILLO
- M MATEADO
- BRILLO
- M MATEADO
- BRILLO
- M MATEADO
- BLACK LINE
- BRILLO
- BRILLO
- BLACK LINE
- BRILLO
- BRILLO
- BLACK LINE
- BRILLO
- BRILLO
- BLACK LINE
- BRILLO
- BLACK LINE
- BRILLO
- M MATEADO
- M MATEADO
- BLACK LINE
- BRILLO
- BRILLO
- M MATEADO
- M MATEADO
- BLACK LINE
- M MATEADO
- BLACK LINE
- M MATEADO
- BLACK LINE
- BRILLO
- M MATEADO
- BLACK LINE
- BRILLO
- C COBRE
- BLACK LINE
- BRILLO

- SOLID
- SIDE
- MOON
- STAR
- WALL
- SOLID
- SIDE
- MOON
- SUITE
- PASS
- DUNE
- FORUM
- NEXUS
- INFINITI
- ROLLING
- COMBI
- STAR
- HANDI
- FLEX
- NOVA
- OPEN
- QUADRO
- NATURE
- STYLE
- NEXUS
- TECHNICAL
- ROLLING
- INVISIBLE
- FRAME
- CASSONETTO
- CLICK
- PACK
- HIDRA
- DATOS TÉCNICOS
- DECORADOS

FORUM



FR2

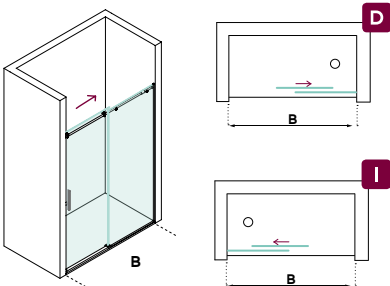





Rango de medida B	G0 Transparente		G1 Mate, Extraclaro, Gris, Bronce		G2 Espejo, Negro	
	B BRILLO	M MATE	B BRILLO	M MATE	B BRILLO	M MATE
Hasta - 120	641	705	725	797	770	846
120 - 140	679	747	768	844	815	897
140 - 160	700	770	791	870	840	924
160 - 180	759	834	857	943	910	1001
180 - 200	796	875	899	989	955	1050

Características

-  1 Fijo y 1 puerta corredera
-  Espesor vidrio 8mm
-  Tratamiento antical a dos caras
-  Impresión digital, consultar pag:274
-  Altura 1950. Máxima hasta 2400mm
-  Ruedas con ajuste vertical
-  Cierre magnético
-  Ancho máximo de la puerta 900mm

Opciones

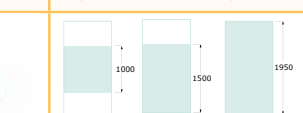
Cambio de tirador por pomo+30	En bañera, h=1500 al mismo precio	Incremento altura, +5% cada 5 cm	Recortes especiales en el vidrio, +90	Impresión digital personalizada, ver pag:274
				
				Opción A Opción B Opción C



FR3

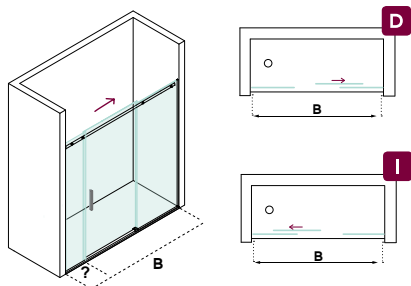

Rango de medida B	G0 Transparente		G1 Mate, Extraclaro, Gris, Bronce		G2 Espejo, Negro	
	B BRILLO	M MATE	B BRILLO	M MATE	B BRILLO	M MATE
Hasta - 160	794	873	889	978	953	1048
160 - 180	825	907	923	1016	989	1088
180 - 200	852	937	954	1050	1022	1125
200 - 220	895	984	1002	1102	1074	1181
220 - 240	934	1028	1046	1151	1121	1233

Características

- 2 Fijos y 1 puerta corredera
- Espesor vidrio 8mm
- Tratamiento antical a dos caras
- Impresión digital, consultar pag:274
- Altura 1950. Máxima hasta 2400mm
- Ruedas con ajuste vertical
- Ancho máximo de la puerta 900mm

Opciones

Cambio de tirador por pomo +30	En bañera, h=1500 al mismo precio	Incremento altura, +5% cada 5 cm	Recortes especiales en el vidrio, +90	Impresión digital personalizada, ver pag:274





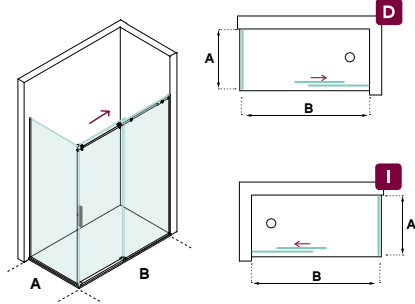



FR3A





Características

-  2 Fijos y 1 puerta corredera
-  Espesor vidrio 8mm
-  Tratamiento antical a dos caras
-  Impresión digital, consultar pag:274
-  Altura 1950. Máxima hasta 2400mm
-  Ruedas con ajuste vertical
-  Ancho máximo de la puerta 900mm

Rango de medida A+B	G0 Transparente		G1 Mate, Extraclaro, Gris, Bronce		G2 Espejo, Negro	
	 BRILLO	 MATE	 BRILLO	 MATE	 BRILLO	 MATE
Hasta - 160	764	840	856	941	917	1008
160 - 180	791	870	885	974	949	1044
180 - 200	820	902	919	1010	984	1083
200 - 220	847	931	948	1043	1016	1118
220 - 240	879	967	985	1083	1055	1161
240 - 260	909	1000	1018	1120	1091	1200
260 - 280	938	1032	1051	1156	1126	1239
280 - 300	965	1062	1081	1189	1158	1274

Opciones

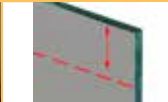
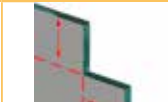
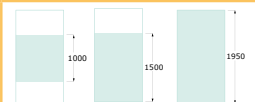
Cambio de tirador por pomo +30	En bañera, h=1500 al mismo precio	Incremento altura, +5% cada 5 cm	Recortes especiales en el vidrio, +90	Impresión digital personalizada, ver pag:274
				
				Opción A Opción B Opción C



FR3AM

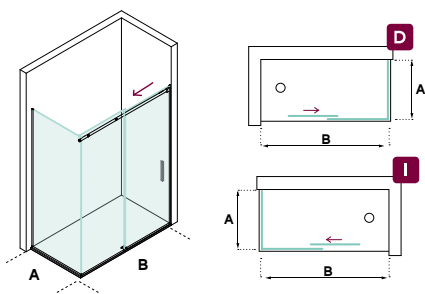



Características

-  2 Fijos y 1 puerta corredera
-  Espesor vidrio 8mm
-  Tratamiento antical a dos caras
-  Impresión digital, consultar pag:274
-  Altura 1950. Máxima hasta 2400mm
-  Ruedas con ajuste vertical
-  Cierre magnético
-  Ancho máximo de la puerta 900mm

Rango de medida A+B	G0 Transparente		G1 Mate, Extraclaro, Gris, Bronce		G2 Espejo, Negro	
	B BRILLO	M MATE	B BRILLO	M MATE	B BRILLO	M MATE
	Hasta - 160	814	895	911	1002	976
160 - 180	840	924	941	1035	1008	1109
180 - 200	870	957	974	1072	1044	1148
200 - 220	896	986	1004	1104	1076	1183
220 - 240	929	1022	1040	1145	1115	1226
240 - 260	959	1054	1074	1181	1150	1265
260 - 280	988	1087	1107	1217	1186	1304
280 - 300	1015	1116	1137	1250	1218	1340

Opciones

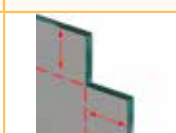
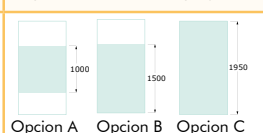
Cambio de tirador por pomo +30	En bañera, h=1500 al mismo precio	Incremento altura, +5% cada 5 cm	Recortes especiales en el vidrio, +90	Impresión digital personalizada, ver pag:274
				





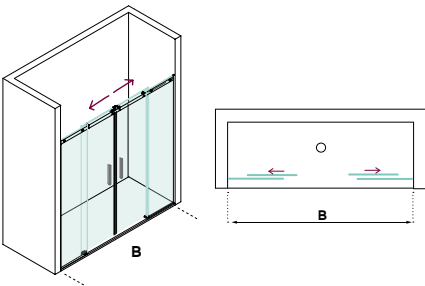



FR4





Características

-  2 Fijos y 2 puertas corredera
-  Espesor vidrio 8mm
-  Tratamiento antical a dos caras
-  Impresión digital, consultar pag:274
-  Altura 1950. Máxima hasta 2400mm
-  Ruedas con ajuste vertical
-  Cierre magnético
-  Ancho máximo de la puerta 600mm

Rango de medida B	G0 Transparente		G1 Mate, Extraclaro, Gris, Bronce		G2 Espejo, Negro	
	 BRILLO	 MATE	 BRILLO	 MATE	 BRILLO	 MATE
Hasta - 120	880	968	986	1084	1056	1162
120 - 140	914	1005	1023	1126	1097	1206
140 - 160	950	1045	1064	1171	1140	1254
160 - 180	966	1062	1082	1190	1159	1275
180 - 200	996	1096	1116	1227	1196	1315
200 - 220	1039	1143	1164	1280	1247	1371

Opciones

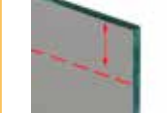
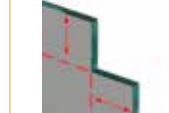
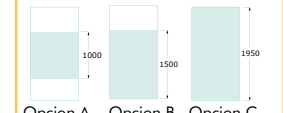
Cambio de tirador por pomo +60	En bañera, h=1500 al mismo precio	Incremento altura, +5% cada 5 cm	Recortes especiales en el vidrio, +90	Impresión digital personalizada, ver pag:274
				
				Opción A Opción B Opción C



FR4U

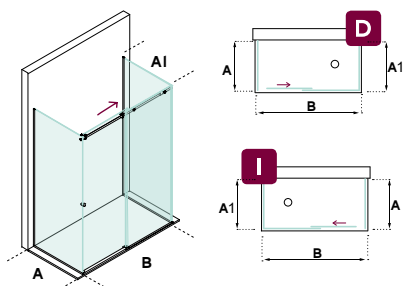

Características

- 3 Fijos y 1 puerta corredera
- Espesor vidrio 8mm
- Tratamiento antical a dos caras
- Impresión digital, consultar pag:274
- Altura 1950. Máxima hasta 2400mm
- Ruedas con ajuste vertical
- Ancho máximo de la puerta 900mm

Rango de medida A+A1+B	G0 Transparente		G1 Mate, Extraclaro, Gris, Bronce		G2 Espejo, Negro	
	Hasta - 260	1267	1394	1420	1561	1521
260 - 300	1330	1463	1490	1639	1596	1756
300 - 340	1441	1585	1614	1775	1729	1902
340 - 380	1548	1703	1734	1907	1857	2043

Opciones

Cambio de tirador por pomo +30	En bañera, h=1500 al mismo precio	Incremento altura, +5% cada 5 cm	Recortes especiales en el vidrio, +90	Impresión digital personalizada, ver pag:274

FORUM

FORUM



FR4A

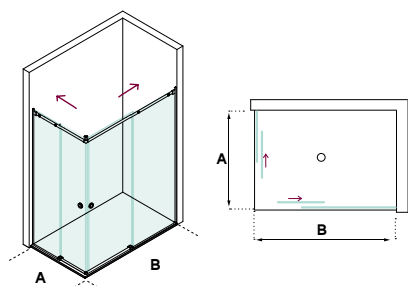

Rango de medida A + B	G0 Transparente		G1 Mate, Extraclaro, Gris, Bronce		G2 Espejo, Negro	
	B BRILLO	M MATE	B BRILLO	M MATE	B BRILLO	M MATE
Hasta - 160	962	1058	1078	1185	1155	1270
160 - 180	977	1075	1094	1204	1173	1290
180 - 200	1013	1114	1134	1248	1215	1337
200 - 220	1051	1156	1177	1295	1261	1387
220 - 240	1083	1192	1213	1335	1300	1430
240 - 260	1157	1273	1296	1426	1389	1528

Características

- 2 Fijos y 2 puertas correderas
- Espesor vidrio 8mm
- Tratamiento antical a dos caras
- Impresión digital, consultar pag:274
- Altura 1950. Máxima hasta 2400mm
- Ruedas con ajuste vertical
- Cierre magnético
- Ancho máximo de la puerta 600mm

Opciones			
En bañera, h=1500 al mismo precio	Incremento altura, +5% cada 5 cm	Recortes especiales en el vidrio, +90	Impresión digital personalizada, ver pag:274
			 Opcion A Opcion B Opcion C

NEXUS

NEXUS



• Ruedas de pinzas con antivuelco



• Guía superior de aluminio.

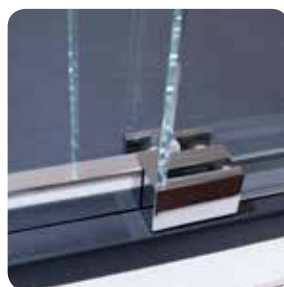

• Guiador metálico.





















































• Freno ralentizado



• Tirador metálico



• Uñero metálico

-  
-  
-  
-  
-  
-  
-  
-  
-   
-  
-  
-  
-  
-  
-  
-  
-  
-   
-  
-  
-  
-   
-   

- SOLID
- SIDE
- MOON
- STAR
- WALL
- SOLID
- SIDE
- MOON
- SUITE
- PASS
- DUNE
- FORUM
- NEXUS
- INFINITI
- ROLLING
- COMBI
- STAR
- HANDI
- FLEX
- NOVA
- OPEN
- QUADRO
- NATURE
- STYLE
- NEXUS
- TECHNICAL
- ROLLING
- INVISIBLE
- FRAME
- CASSONETTO
- CLICK
- PACK
- HIDRA
- DATOS TÉCNICOS
- DECORADOS

NEXUS

NEXUS

NEXUS



NX2

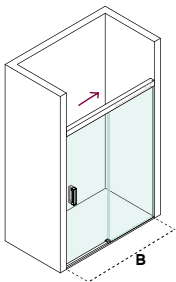



Rango de medida B	G0 Transparente			G1 Mate, Extraclaro, Gris, Bronce			G2 Espejo, Negro		
	M MATE	B BRILLO	BLACK LINE	M MATE	B BRILLO	BLACK LINE	M MATE	B BRILLO	BLACK LINE
Hasta-120	838	972	972	946	1098	1098	1005	1166	1166
120 - 140	857	991	991	968	1120	1120	1028	1189	1189
140 - 160	874	1008	1008	987	1139	1139	1048	1210	1210
160 - 180	893	1027	1027	1009	1161	1161	1071	1233	1233
180 - 200	912	1046	1046	1031	1182	1182	1094	1256	1256

Características

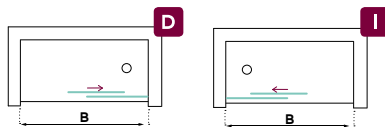
-  1 Fijo y 1 puerta corredera
-  Espesor vidrio 8mm
-  Tratamiento antical a dos caras
-  Impresión digital, consultar pag:274
-  Altura 2000. Máxima hasta 2400mm
-  Ruedas con ajuste vertical
-  Cierre magnético
-  Cierre amortiguado
-  Ancho máximo de la puerta 1200mm

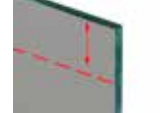
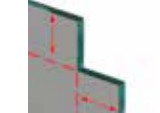
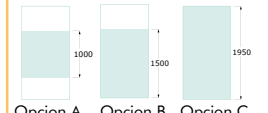

Opciones

Cambio de tirador por uñero+30	En bañera,h=1500 al mismo precio	Incremento altura, +5% cada 5 cm	Recortes especiales en el vidrio, +90	Impresión digital personalizada,ver pag:274
				
				Opción A Opción B Opción C



NX3

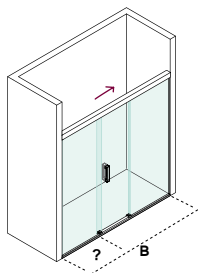

Características

- 2 Fijos 1 puerta corredera
- Espesor vidrio 8mm
- Tratamiento antical a dos caras
- Impresión digital, consultar pag:274
- Altura 2000. Máxima hasta 2400mm
- Ruedas con ajuste vertical
- Cierre amortiguado
- Ancho máximo de la puerta 1200mm

Rango de medida B	G0 Transparente			G1 Mate, Extraclaro, Gris, Bronce			G2 Espejo, Negro		
	M MATE	B BRILLO	BLACK LINE	M MATE	B BRILLO	BLACK LINE	M MATE	B BRILLO	BLACK LINE
Hasta-160	991	1122	1122	1120	1268	1268	1189	1347	1347
160 - 180	1010	1150	1150	1142	1299	1299	1212	1380	1380
180 - 200	1025	1172	1172	1158	1325	1325	1230	1407	1407
200 - 220	1079	1239	1239	1219	1401	1401	1295	1487	1487
220 - 240	1096	1265	1265	1239	1430	1430	1315	1518	1518
240 - 260	1140	1291	1291	1289	1459	1459	1369	1549	1549
260 - 280	1161	1319	1319	1312	1490	1490	1393	1583	1583
280 - 300	1196	1362	1362	1352	1539	1539	1436	1634	1634

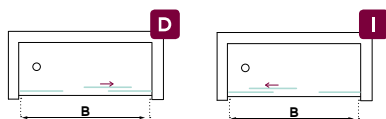

Opciones

Cambio de tirador por uñero+30	En bañera,h=1500 al mismo precio	Incremento altura, +5% cada 5 cm	Recortes especiales en el vidrio, +90	Impresión digital personalizada,ver pag:274
				<p>Opción A Opción B Opción C</p>

NEXUS

NEXUS



NX3A

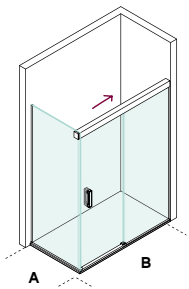

Rango de medida A+B	G0 Transparente			G1 Mate, Extraclaro, Gris, Bronce			G2 Espejo, Negro		
	M MATE	B BRILLO	BLACK LINE	M MATE	B BRILLO	BLACK LINE	M MATE	B BRILLO	BLACK LINE
Hasta-160	1028	1134	1134	1162	1281	1281	1234	1360	1360
160 - 180	1043	1224	1224	1178	1383	1383	1251	1468	1468
180 - 200	1095	1241	1241	1237	1402	1402	1314	1489	1489
200 - 220	1110	1256	1256	1254	1419	1419	1331	1507	1507
220 - 240	1129	1276	1276	1276	1442	1442	1355	1531	1531
240 - 260	1147	1294	1294	1296	1462	1462	1376	1552	1552
260 - 280	1192	1332	1332	1347	1505	1505	1431	1598	1598
280 - 300	1208	1347	1347	1364	1522	1522	1449	1617	1617

Características

- 2 Fijos 1 puerta corredera
- Espesor vidrio 8mm
- Tratamiento antical a dos caras
- Impresión digital, consultar pag:274
- Altura 2000. Máxima hasta 2400mm
- Ruedas con ajuste vertical
- Cierre amortiguado
- Ancho máximo de la puerta 1200mm

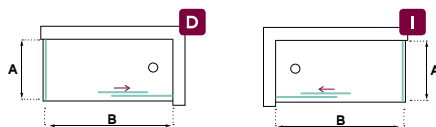

Opciones

Cambio de tirador por uñero+30	En bañera,h=1500 al mismo precio	Incremento altura, +5% cada 5 cm	Recortes especiales en el vidrio, +90	Impresión digital personalizada,ver pag:274



NX3AM

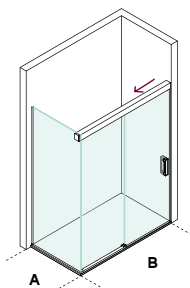

Características

- 2 Fijos y 1 puerta
- Espesor vidrio 8mm
- Tratamiento antical a dos caras
- Impresión digital, consultar pag:274
- Altura 2000. Máxima hasta 2400mm
- Ruedas con ajuste vertical
- Cierre magnético
- Cierre amortiguado
- Ancho máximo de la puerta 1200mm

Rango de medida A+B	G0 Transparente			G1 Mate, Extraclaro, Gris, Bronce			G2 Espejo, Negro		
	M MATE	B BRILLO	BLACK LINE	M MATE	B BRILLO	BLACK LINE	M MATE	B BRILLO	BLACK LINE
Hasta-160	1068	1209	1209	1206	1366	1366	1281	1451	1451
160 - 180	1088	1260	1260	1229	1424	1424	1305	1512	1512
180 - 200	1103	1275	1275	1246	1441	1441	1323	1530	1530
200 - 220	1123	1306	1306	1268	1475	1475	1347	1567	1567
220 - 240	1140	1324	1324	1288	1496	1496	1368	1588	1588
240 - 260	1158	1341	1341	1308	1516	1516	1389	1610	1610
260 - 280	1196	1383	1383	1352	1563	1563	1436	1660	1660
280 - 300	1219	1407	1407	1378	1589	1589	1463	1688	1688

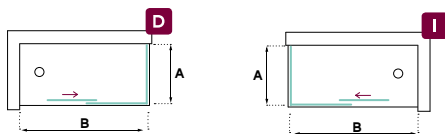

Opciones

Cambio de tirador por uñero+30	En bañera,h=1500 al mismo precio	Incremento altura, +5% cada 5 cm	Recortes especiales en el vidrio, +90	Impresión digital personalizada,ver pag:274
				Opción A Opción B Opción C

NEXUS



NEXUS

NX4

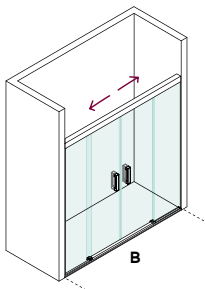



Características

-  2 Fijos y 2 puertas
-  Espesor vidrio 8mm
-  Tratamiento antical a dos caras
-  Impresión digital, consultar pag:274
-  Altura 2000. Máxima hasta 2400mm
-  Ruedas con ajuste vertical
-  Cierre magnético
-  Cierre amortiguado
-  Ancho máximo de la puerta 750mm

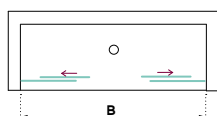
Rango de medida B	G0 Transparente			G1 Mate, Extraclaro, Gris, Bronce			G2 Espejo, Negro		
	M MATE	B BRILLO	BLACK LINE	M MATE	B BRILLO	BLACK LINE	M MATE	B BRILLO	BLACK LINE
Hasta-160	1302	1490	1490	1432	1639	1639	1575	1803	1803
160 - 180	1325	1513	1513	1457	1664	1664	1603	1830	1830
180 - 200	1348	1535	1535	1482	1688	1688	1631	1857	1857
200 - 220	1382	1548	1548	1520	1702	1702	1672	1873	1873
220 - 240	1384	1575	1575	1523	1732	1732	1675	1905	1905
240 - 260	1428	1597	1597	1571	1757	1757	1728	1932	1932
260 - 280	1434	1615	1615	1577	1776	1776	1735	1954	1954
280 - 300	1445	1625	1625	1589	1788	1788	1748	1966	1966

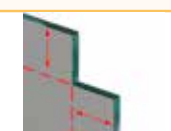
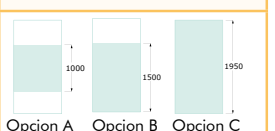

Opciones

Cambio de tirador por uñero+60	En bañera, h=1500 al mismo precio	Incremento altura, +5% cada 5 cm	Recortes especiales en el vidrio, +90	Impresión digital personalizada, ver pag:274
				
				Opción A Opción B Opción C



NX4A

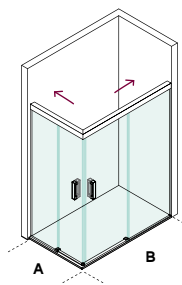



Características

-  2 Fijos y 2 puertas
-  Espesor vidrio 8mm
-  Tratamiento antical a dos caras
-  Impresión digital, consultar pag:274
-  Altura 2000. Máxima hasta 2400mm
-  Ruedas con ajuste vertical
-  Cierre magnético
-  Cierre amortiguado
-  Ancho máximo de la puerta 600mm

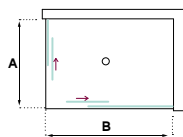
Rango de medida A+B	G0 Transparente			G1 Mate, Extraclaro, Gris, Bronce			G2 Espejo, Negro		
	M MATE	B BRILLO	BLACK LINE	M MATE	B BRILLO	BLACK LINE	M MATE	B BRILLO	BLACK LINE
Hasta-160	1420	1636	1636	1562	1800	1800	1719	1980	1980
160 - 180	1442	1657	1657	1586	1823	1823	1745	2005	2005
180 - 200	1464	1678	1678	1610	1846	1846	1771	2031	2031
200 - 220	1488	1718	1718	1637	1890	1890	1801	2079	2079
220 - 240	1491	1721	1721	1640	1893	1893	1804	2082	2082
240 - 260	1542	1776	1776	1696	1953	1953	1866	2149	2149
260 - 280	1547	1781	1781	1702	1959	1959	1872	2155	2155
280 - 300	1557	1791	1791	1713	1970	1970	1884	2167	2167

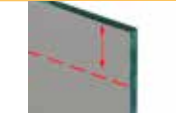
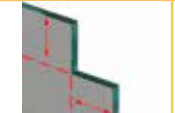
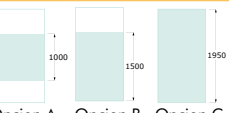

Opciones

Cambio de tirador por uñero+60	En bañera,h=1500 al mismo precio	Incremento altura, +5% cada 5 cm	Recortes especiales en el vidrio, +90	Impresión digital personalizada,ver pag:274
				
				Opcion A Opcion B Opcion C

INFINITI

INFINITI



• Ruedas de pinzas metálicas



• Soporte regulable de guía



• Freno ralentizado incorporado



• Guiador de policarbonato



• Guía superior de aluminio



• Tirador metálico

- B** BRILLO
- B** BRILLO
- B** BRILLO
- B** BRILLO
- BLACK LINE** **B** BRILLO
- B** BRILLO
- B** BRILLO
- BLACK LINE** **B** BRILLO
- B** BRILLO
- B** BRILLO
- M** MATEADO **B** BRILLO
- M** MATEADO **B** BRILLO
- M** MATEADO **BLACK LINE** **B** BRILLO
- B** BRILLO
- B** BRILLO
- BLACK LINE** **B** BRILLO
- BLACK LINE** **B** BRILLO
- B** BRILLO
- B** BRILLO
- BLACK LINE** **B** BRILLO
- B** BRILLO
- BLACK LINE** **B** BRILLO
- BLACK LINE** **B** BRILLO
- M** MATEADO
- M** MATEADO **BLACK LINE**
- B** BRILLO
- B** BRILLO
- M** MATEADO
- M** MATEADO **BLACK LINE**
- M** MATEADO
- M** MATEADO **BLACK LINE**
- M** MATEADO **BLACK LINE** **B** BRILLO
- C** COBRE **BLACK LINE** **B** BRILLO

- SOLID
- SIDE
- MOON
- STAR
- WALL
- SOLID
- SIDE
- MOON
- SUITE
- PASS
- DUNE
- FORUM
- NEXUS
- INFINITI
- ROLLING
- COMBI
- STAR
- HANDI
- FLEX
- NOVA
- OPEN
- QUADRO
- NATURE
- STYLE
- NEXUS
- TECHNICAL
- ROLLING
- INVISIBLE
- FRAME
- CASSONETTO
- CLICK
- PACK
- HIDRA
- DATOS TÉCNICOS
- DECORADOS







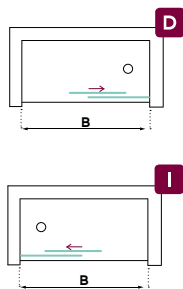
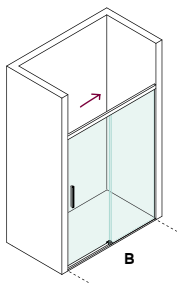

INFINITI





IN2



Características

-  1 Fijo y 1 puerta corredera
-  Espesor vidrio 8mm
-  Tratamiento antical a dos caras
-  Impresión digital, consultar pag:274
-  Altura 2000. Máxima hasta 2400mm
-  Ruedas con ajuste vertical
-  Cierre magnético
-  Cierre amortiguado
-  Ancho máximo de la puerta 885mm

Rango de medida B	G0 Transparente	G1 Mate, Extraclaro, Gris, Bronce	G2 Espejo, Negro
	 BRILLO	 BRILLO	 BRILLO
Hasta 110	1078	1218	1293
110 - 120	1096	1238	1315
120 - 130	1114	1259	1337
130 - 140	1132	1279	1359
140 - 150	1150	1300	1380
150 - 160	1277	1443	1532
160 - 170	1289	1457	1547

Opciones

En bañera, h=1500 al mismo precio	Incremento altura, +5% cada 5 cm	Recortes especiales en el vidrio, +90	Impresión digital personalizada, ver pag:274
			



IN3A

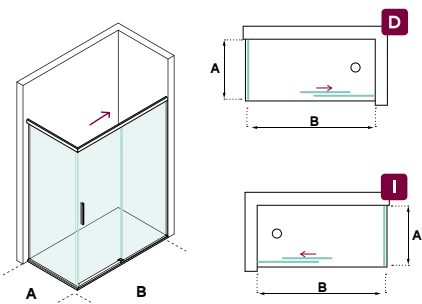

Rango de medida A+B	G0 Transparente	G1 Mate, Extraclaro, Gris, Bronce	G2 Espejo, Negro
	B BRILLO	B BRILLO	B BRILLO
Hasta 170	1523	1721	1827
170 - 190	1548	1750	1858
190 - 210	1579	1784	1895
210 - 230	1607	1816	1928
230 - 250	1635	1848	1962

Características

- 2 Fijos y 1 puerta corredera
- Espesor vidrio 8mm
- Tratamiento antical a dos caras
- Impresión digital, consultar pag:274
- Altura 2000. Máxima hasta 2400mm
- Ruedas con ajuste vertical
- Cierre amortiguado
- Ancho máximo de la puerta 885mm

Opciones





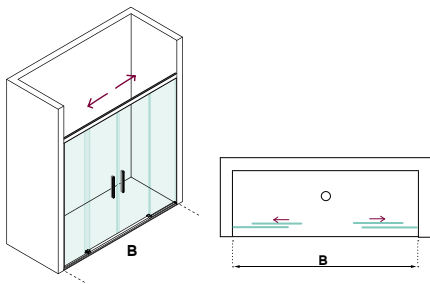

En bañera, h=1500 al mismo precio	Incremento altura, +5% cada 5 cm	Recortes especiales en el vidrio, +90	Impresión digital personalizada, ver pag:274
			<p>Opcion A Opcion B Opcion C</p>







IN4



Características

-  1 Fijo y 1 puerta corredera
-  Espesor vidrio 8mm
-  Tratamiento antical a dos caras
-  Impresión digital, consultar pag:274
-  Altura 2000. Máxima hasta 2400mm
-  Ruedas con ajuste vertical
-  Cierre magnético
-  Cierre amortiguado
-  Ancho máximo de la puerta 500mm

Rango de medida B	G0 Transparente	G1 Mate, Extraclaro, Gris, Bronce	G2 Espejo, Negro
			
Hasta 160	1625	1788	1967
160 - 180	1659	1825	2008
180 - 200	1693	1862	2048

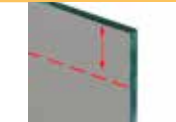
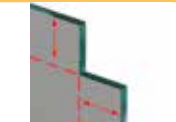
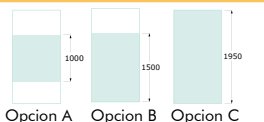
Opciones			
En bañera, h=1500 al mismo precio	Incremento altura, +5% cada 5 cm	Recortes especiales en el vidrio, +90	Impresión digital personalizada, ver pag:274
			 Opcion A Opcion B Opcion C



INFINITI

IN4A

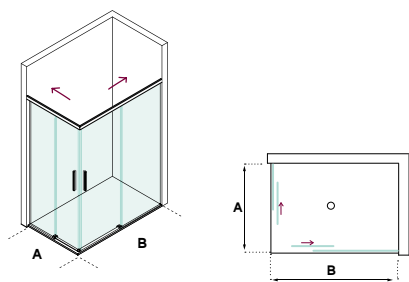

Rango de medida A+B	G0 Transparente	G1 Mate, Extraclaro, Gris, Bronce	G2 Espejo, Negro
	B BRILLO	B BRILLO	B BRILLO
Hasta 160	1845	2029	2232
160 - 180	1878	2066	2272
180 - 200	1911	2102	2312
200 - 220	1922	2115	2326
220 - 240	1934	2128	2340
240 - 260	1951	2146	2360
260 - 280	1965	2162	2378
280 - 300	1985	2184	2402

Características

- 2 Fijos y 2 puertas correderas
- Espesor vidrio 8mm
- Tratamiento antical a dos caras
- Impresión digital, consultar pag:274
- Altura 2000. Máxima hasta 2400mm
- Ruedas con ajuste vertical
- Cierre amortiguado
- Ancho máximo de la puerta 500mm

Opciones

En bañera, h=1500 al mismo precio	Incremento altura, +5% cada 5 cm	Recortes especiales en el vidrio, +90	Impresión digital personalizada, ver pag:274
			 Opcion A Opcion B Opcion C

ROLLING

ROLLING



• Ruedas inferiores guiadas



• Soporte a pared metálico



• Perfil lateral con emnellecedor



• Uñero metálico



• Guiador superior

- B BRILLO
- B BRILLO
- B BRILLO
- B BRILLO
- BLACK LINE
- B BRILLO
- B BRILLO
- BLACK LINE
- B BRILLO
- B BRILLO
- M MATEADO
- B BRILLO
- M MATEADO
- B BRILLO
- M MATEADO
- BLACK LINE
- B BRILLO
- B BRILLO
- BLACK LINE
- B BRILLO
- B BRILLO
- BLACK LINE
- B BRILLO
- BLACK LINE
- B BRILLO
- BLACK LINE
- B BRILLO
- M MATEADO
- B BRILLO
- M MATEADO
- BLACK LINE
- B BRILLO
- B BRILLO
- M MATEADO
- B BRILLO
- M MATEADO
- BLACK LINE
- M MATEADO
- BLACK LINE
- M MATEADO
- BLACK LINE
- M MATEADO
- BLACK LINE
- B BRILLO
- M MATEADO
- BLACK LINE
- B BRILLO
- C COBRE
- BLACK LINE
- B BRILLO

- SOLID
- SIDE
- MOON
- STAR
- WALL
- SOLID
- SIDE
- MOON
- SUITE
- PASS
- DUNE
- FORUM
- NEXUS
- INFINITI
- ROLLING
- COMBI
- STAR
- HANDI
- FLEX
- NOVA
- OPEN
- QUADRO
- NATURE
- STYLE
- NEXUS
- TECHNICAL
- ROLLING
- INVISIBLE
- FRAME
- CASSONETTO
- CLICK
- PACK
- HIDRA
- DATOS TÉCNICOS
- DECORADOS

ROLLING

ROLLING

ROLLING



RL2V

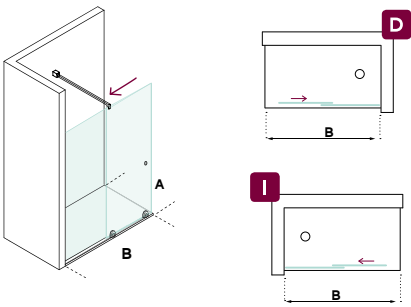

Rango de medida B	G0 Transparente	G1 Mate, Extraclaro, Gris, Bronce	G2 Espejo, Negro
	B BRILLO	B BRILLO	B BRILLO
Hasta 120	595	672	714
120 - 140	633	715	759
140 - 160	660	746	792
160 - 180	695	785	833
180 - 200	736	831	883

Características

-  1 Fijo y 1 puerta corredera
-  Espesor vidrio 8mm
-  Tratamiento antical a dos caras
-  Impresión digital, consultar pag:274
-  Altura 1950. Máxima hasta 2200mm
-  Ruedas con ajuste vertical
-  Ancho máximo de la puerta 1000mm

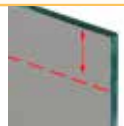
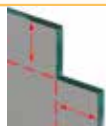
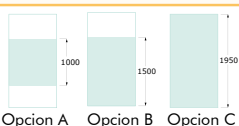
Opciones		
Incremento altura, +5% cada 5 cm	Recortes especiales en el vidrio, +90	Impresión digital personalizada, ver pag:274
		 Opcion A Opcion B Opcion C



RL2

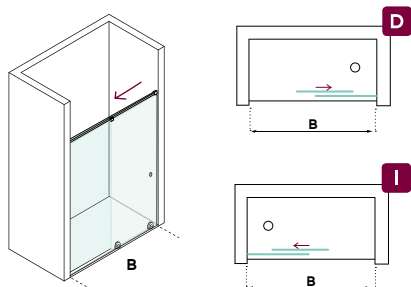

Rango de medida B	G0 Transparente	G1 Mate, Extraclaro, Gris, Bronce	G2 Espejo, Negro
	B BRILLO	B BRILLO	B BRILLO
Hasta 120	650	735	780
120 - 140	688	777	826
140 - 160	716	809	859
160 - 180	750	847	900
180 - 200	791	894	949

Características

-  1 Fijo y 1 puerta corredera
-  Espesor vidrio 8mm
-  Tratamiento antical a dos caras
-  Impresión digital, consultar pag:274
-  Altura 1950. Máxima hasta 2200mm
-  Ruedas con ajuste vertical
-  Cierre magnético
-  Ancho máximo de la puerta 1000mm

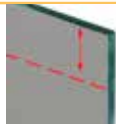
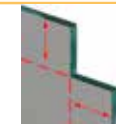
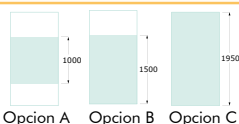
Opciones		
Incremento altura, +5% cada 5 cm	Recortes especiales en el vidrio, +90	Impresión digital personalizada, ver pag:274
		

ROLLING

ROLLING

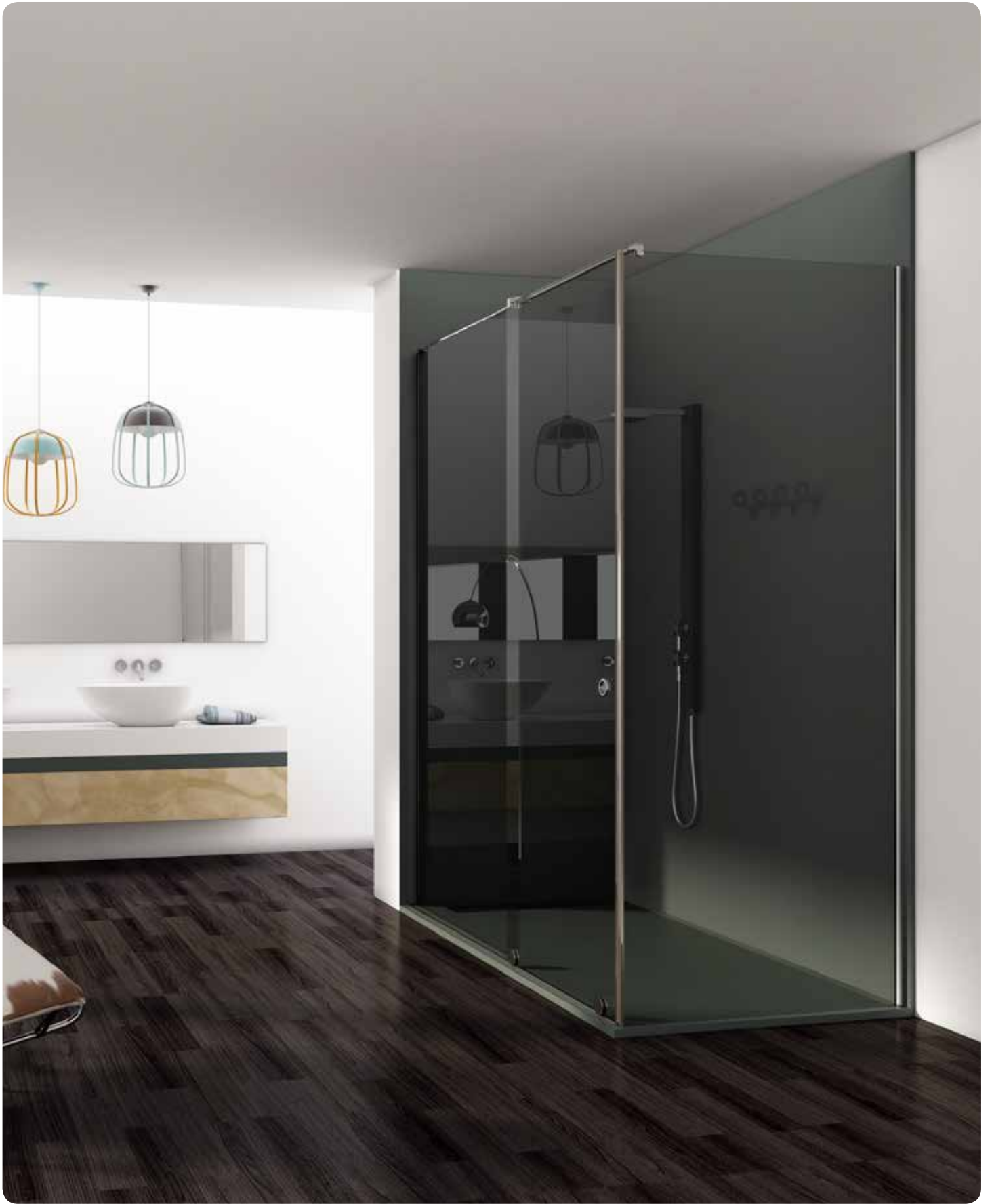

RL3A

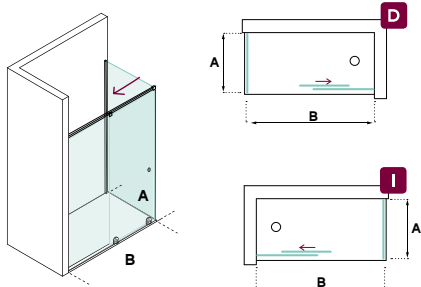

Rango de medida A + B	G0 Transparente	G1 Mate, Extraclaro, Gris, Bronce	G2 Espejo, Negro
Hasta 180	900	1.017	1.080
180 - 200	935	1.056	1.121
200 - 220	965	1.091	1.158
220 - 240	1.003	1.133	1.204
240 - 260	1.037	1.172	1.245
260 - 280	1.072	1.211	1.286
280 - 300	1.102	1.246	1.323

Características

- 2 Fijos y 1 puerta corredera
- Espesor vidrio 8mm
- Tratamiento antical a dos caras
- Impresión digital, consultar pag:274
- Altura 1950. Máxima hasta 2200mm
- Ruedas con ajuste vertical
- Ancho máximo de la puerta 1000mm

Opciones		
Incremento altura, +5% cada 5 cm	Recortes especiales en el vidrio, +90	Impresión digital personalizada, ver pag:274
		 Opcion A Opcion B Opcion C

COMBI

COMBI



• Brazo largo de refuerzo en acero



• Perfil lateral en aluminio brillo



• Bisagras en acero



• Guiador metálico.



• Guía superior de aluminio.



• Tirador metálico

- B** BRILLO
- B** BRILLO
- B** BRILLO
- B** BRILLO
- BLACK LINE** **B** BRILLO
- B** BRILLO
- B** BRILLO
- BLACK LINE** **B** BRILLO
- B** BRILLO
- B** BRILLO
- M** MATEADO **B** BRILLO
- M** MATEADO **B** BRILLO
- M** MATEADO **BLACK LINE** **B** BRILLO
- B** BRILLO
- B** BRILLO
- BLACK LINE** **B** BRILLO
- BLACK LINE** **B** BRILLO
- B** BRILLO
- B** BRILLO
- BLACK LINE** **B** BRILLO
- B** BRILLO
- BLACK LINE** **B** BRILLO
- BLACK LINE** **B** BRILLO
- M** MATEADO
- M** MATEADO **BLACK LINE**
- B** BRILLO
- B** BRILLO
- M** MATEADO
- M** MATEADO **BLACK LINE**
- M** MATEADO **BLACK LINE**
- M** MATEADO **BLACK LINE** **B** BRILLO
- M** MATEADO **BLACK LINE** **B** BRILLO
- C** COBRE **BLACK LINE** **B** BRILLO

- SOLID
- SIDE
- MOON
- STAR
- WALL
- SOLID
- SIDE
- MOON
- SUITE
- PASS
- DUNE
- FORUM
- NEXUS
- INFINITI
- ROLLING
- COMBI
- STAR
- HANDI
- FLEX
- NOVA
- OPEN
- QUADRO
- NATURE
- STYLE
- NEXUS
- TECHNICAL
- ROLLING
- INVISIBLE
- FRAME
- CASSONETTO
- CLICK
- PACK
- HIDRA
- DATOS TÉCNICOS
- DECORADOS







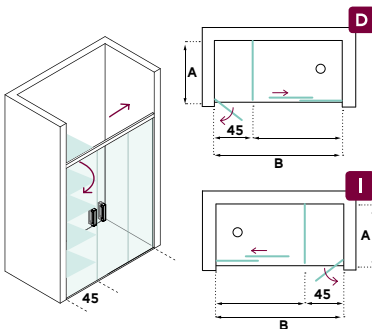

COMBI



CC4S



Características

-  1 Fijo ,1 puerta corredera y 1 puerta batiente
-  Espesor vidrio 8mm
-  Tratamiento antical a dos caras
-  Impresión digital, consultar pag:274
-  Altura 2000.
-  Ruedas con ajuste vertical
-  Cierre magnético
-  Cierre amortiguado
-  Armario de 45 cm con 4 estantes y tapa superior

Rango de medida A + B	G0 Transparente		G1 Mate, Extraclaro, Gris, Bronce		G2 Espejo, Negro	
	 MATE	 BLACK LINE	 MATE	 BLACK LINE	 MATE	 BLACK LINE
Hasta 240	1858	2137	2100	2414	2230	2564
240 - 260	1881	2163	2126	2444	2257	2596
260 - 280	1918	2206	2167	2492	2302	2647
280 - 300	1935	2225	2187	2515	2322	2670







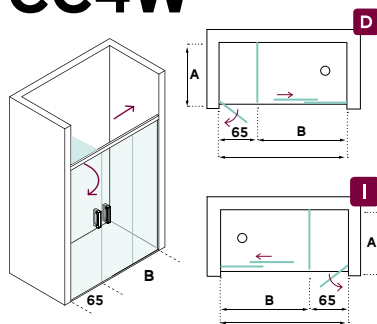



COMBI

CC4W



Rango de medida B	G0 Transparente		G1 Mate, Extraclaro, Gris, Bronce		G2 Espejo, Negro	
	M MATE	N BLACK LINE	M MATE	N BLACK LINE	M MATE	N BLACK LINE
Hasta 240	1547	1779	1748	2010	1856	2135
240 - 260	1570	1806	1774	2040	1884	2167
260 - 280	1607	1848	1816	2088	1928	2218
280 - 300	1624	1868	1835	2110	1949	2241

Características

-  1 Fijo ,1 puerta corredera y 1 puerta batiente
-  Espesor vidrio 8mm
-  Tratamiento antical a dos caras
-  Impresión digital, consultar pag:274
-  Altura 2000.
-  Ruedas con ajuste vertical
-  Cierre magnético
-  Cierre amortiguado
-  Armario de 65cm con tapa superior

COMBI





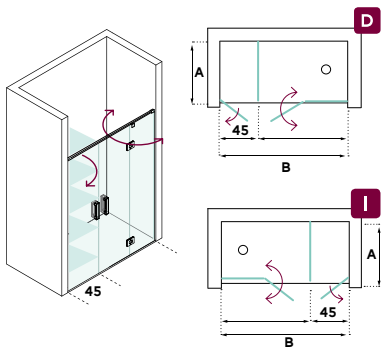

COMBI



CB4S



Características

-  1 Fijo y 2 puertas batientes
-  Espesor de vidrio 8 mm
-  Tratamiento antical a dos caras
-  Impresión digital, consultar pag:274
-  Altura 2000
-  Cierre magnético
-  Armario de 45 cm con 4 estantes y tapa superior

Rango de medida A+B	G0 Transparente		G1 Mate, Extraclaro, Gris, Bronce		G2 Espejo, Negro	
	 BRILLO	 BLACK LINE	 BRILLO	 BLACK LINE	 BRILLO	 BLACK LINE
Hasta 240	1755	2019	1984	2281	2106	2422
240 - 260	1777	2044	2008	2309	2132	2452
260 - 280	1812	2084	2047	2354	2174	2500
280 - 300	1828	2102	2065	2375	2193	2522



CB4W

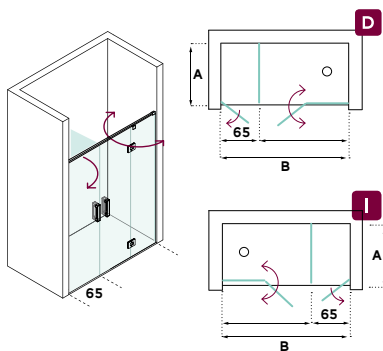

Rango de medida A + B	G0 Transparente		G1 Mate, Extraclaro, Gris, Bronce		G2 Espejo, Negro	
	B BRILLO	N BLACK LINE	B BRILLO	N BLACK LINE	B BRILLO	N BLACK LINE
Hasta 240	1444	1661	1632	1877	1733	1993
240 - 260	1466	1686	1657	1905	1759	2023
260 - 280	1501	1726	1696	1950	1801	2071
280 - 300	1517	1744	1714	1971	1820	2093

Características

-  1 Fijo y 2 puertas batientes
-  Espesor de vidrio 8 mm
-  Tratamiento antical a dos caras
-  Impresión digital, consultar pag:274
-  Altura 2000
-  Cierre magnético
-  Armario de 65 cm con tapa superior

STAR

STAR



• Brazos de refuerzo en acero



• Perfil lateral en aluminio brillo



• Remates inferiores metálicos





















































• Perfil rotación con elevación



• Pomo cónico metálico



• Tirador metálico

-  B BRILLO
-  B BRILLO
-  B BRILLO
-  B BRILLO
-  BLACK LINE
-  B BRILLO
-  B BRILLO
-  B BRILLO
-  BLACK LINE
-  B BRILLO
-  B BRILLO
-  B BRILLO
-  M MATEADO
-  B BRILLO
-  M MATEADO
-  B BRILLO
-  M MATEADO
-  BLACK LINE
-  B BRILLO
-  B BRILLO
-  B BRILLO
-  BLACK LINE
-  B BRILLO
-  BLACK LINE
-  B BRILLO
-  B BRILLO
-  B BRILLO
-  BLACK LINE
-  B BRILLO
-  B BRILLO
-  BLACK LINE
-  B BRILLO
-  M MATEADO
-  M MATEADO
-  BLACK LINE
-  B BRILLO
-  B BRILLO
-  M MATEADO
-  M MATEADO
-  BLACK LINE
-  M MATEADO
-  BLACK LINE
-  M MATEADO
-  BLACK LINE
-  B BRILLO
-  M MATEADO
-  BLACK LINE
-  B BRILLO
-  C COBRE
-  BLACK LINE
-  B BRILLO

- SOLID
- SIDE
- MOON
- STAR
- WALL
- SOLID
- SIDE
- MOON
- SUITE
- PASS
- DUNE
- FORUM
- NEXUS
- INFINITI
- ROLLING
- COMBI
- STAR
- HANDI
- FLEX
- NOVA
- OPEN
- QUADRO
- NATURE
- STYLE
- NEXUS
- TECHNICAL
- ROLLING
- INVISIBLE
- FRAME
- CASSONETTO
- CLICK
- PACK
- HIDRA
- DATOS TÉCNICOS
- DECORADOS

STAR



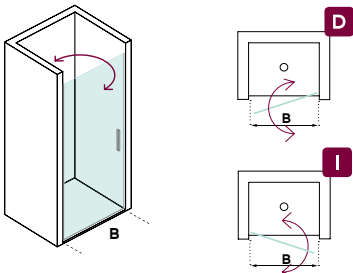

STI



Rango de medida B	G0 Transparente		G1 Mate, Extraclaro, Gris, Bronce		G2 Espejo, Negro	
	B BRILLO	N BLACK LINE	B BRILLO	N BLACK LINE	B BRILLO	N BLACK LINE
Hasta 70	379	417	428	471	514	565
70 - 80	393	433	445	489	534	587
80 - 90	401	441	453	498	543	598

Características

-  1 puerta con apertura 180 °
-  Espesor vidrio 6mm
-  Tratamiento antical a dos caras
-  Impresión digital, consultar pag:274
-  Altura 1950. Máxima hasta 2200mm
-  Cierre magnético
-  Ancho máximo de la puerta 900mm

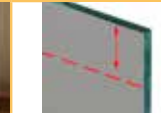
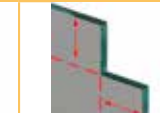
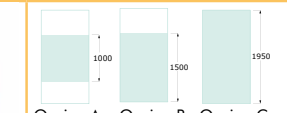
Opciones				
Cambio de tirador por pomo +30	En bañera, h=1500 al mismo precio	Incremento altura, +5% cada 5 cm	Recortes especiales en el vidrio, +90	Impresión digital personalizada, ver pag:274
				
				Opción A Opción B Opción C



ST2A

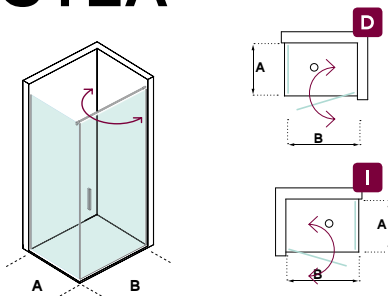

Rango de medida A+B	G0 Transparente		G1 Mate, Extraclaro, Gris, Bronce		G2 Espejo, Negro	
	B BRILLO	BLACK LINE	B BRILLO	BLACK LINE	B BRILLO	BLACK LINE
Hasta 130	572	629	646	711	775	853
130 - 160	612	673	691	760	830	913
160 - 190	645	709	729	801	874	962
190 - 210	682	751	771	848	925	1018
210 - 220	719	791	813	894	975	1073

Características

- 1 puerta con apertura 180°
- Espesor vidrio 6mm
- Tratamiento antical a dos caras
- Impresión digital, consultar pag:274
- Altura 1950. Máxima hasta 2200mm
- Cierre magnético
- Ancho máximo de la puerta 900mm





Opciones				
Cambio de tirador por pomo+30	En bañera,h= 1500 al mismo precio	Incremento altura, +5% cada 5 cm	Recortes especiales en el vidrio, +90	Impresión digital personalizada,ver pag:274

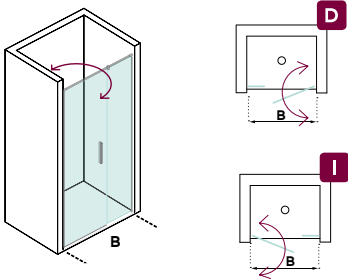

ST2F







Características

-  1 fijo y 1 puerta con apertura 180°
-  Espesor vidrio 6mm
-  Tratamiento antical a dos caras
-  Impresión digital, consultar pag:274
-  Altura 1950. Máxima hasta 2200mm
-  Cierre magnético
-  Ancho máximo de la puerta 900mm

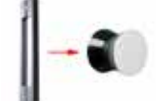
Rango de medida B	G0 Transparente		G1 Mate, Extraclaro, Gris, Bronce		G2 Espejo, Negro	
	B BRILLO	N BLACK LINE	B BRILLO	N BLACK LINE	B BRILLO	N BLACK LINE
Hasta 80	479	527	541	595	649	714
80 - 100	504	554	569	626	683	751
100 - 120	533	586	602	662	722	794
120 - 140	554	610	626	689	751	827
140 - 160	576	633	651	716	781	859
160 - 180	614	675	694	763	832	916
180 - 200	641	705	724	796	869	956

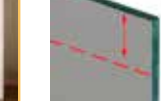
Opciones

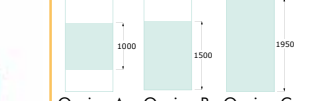
Cambio de tirador por pomo+30	En bañera, h=1500 al mismo precio	Incremento altura, +5% cada 5 cm	Recortes especiales en el vidrio, +90	Impresión digital personalizada, ver pag:274
				
				Opción A Opción B Opción C



ST2

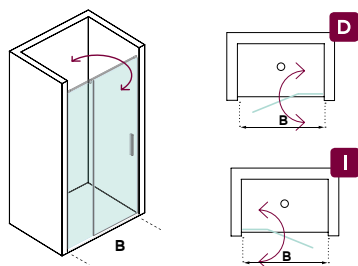

Rango de medida B	G0 Transparente		G1 Mate, Extraclaro, Gris, Bronce		G2 Espejo, Negro	
	B BRILLO	BLACK LINE	B BRILLO	BLACK LINE	B BRILLO	BLACK LINE
Hasta 80	502	552	541	595	649	714
80 - 100	528	581	569	626	683	751
100 - 120	558	614	602	662	722	794
120 - 140	581	639	626	689	751	827
140 - 160	604	664	651	716	781	859
160 - 180	644	708	694	763	832	916
180 - 200	672	739	724	796	869	956

Características

- 1 fijo y 1 puerta con apertura 180 °
- Espesor vidrio 6mm
- Tratamiento antical a dos caras
- Impresión digital, consultar pag:274
- Altura 1950. Máxima hasta 2200mm
- Cierre magnético
- Ancho máximo de la puerta 900mm

Opciones				
Cambio de tirador por pomo+30	En bañera,h=1500 al mismo precio	Incremento altura, +5% cada 5 cm	Recortes especiales en el vidrio, +90	Impresión digital personalizada,ver pag:274



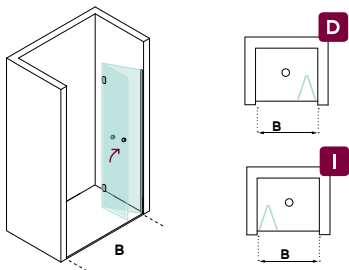

STAR

ST2P



Rango de medida B	G0 Transparente		G1 Mate, Extraclaro, Gris, Bronce		G2 Espejo, Negro	
	B BRILLO	N BLACK LINE	B BRILLO	N BLACK LINE	B BRILLO	N BLACK LINE
Hasta 60	517	569	584	643	701	771
60 - 80	548	603	619	681	743	817
80 - 90	580	638	655	721	786	865

Características

-  2 puertas plegables
-  Espesor vidrio 6mm
-  Tratamiento antical a dos caras
-  Impresión digital, consultar pag:274
-  Altura 1950. Máxima hasta 2200mm
-  Cierre magnético
-  Ancho máximo de la puerta 900mm

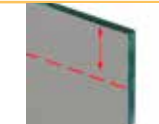
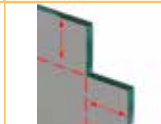
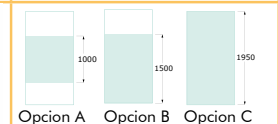
Opciones			
En bañera, h= 1500 al mismo precio	Incremento altura, +5% cada 5 cm	Recortes especiales en el vidrio, +90	Impresión digital personalizada, ver pag:274
			



ST2R

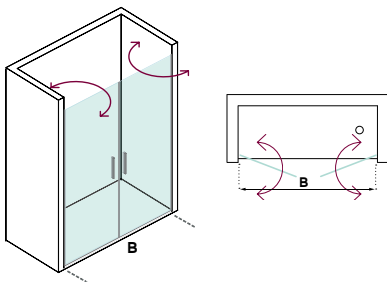

Rango de medida B	G0 Transparente		G1 Mate, Extraclaro, Gris, Bronce		G2 Espejo, Negro	
	B BRILLO	BLACK LINE	B BRILLO	BLACK LINE	B BRILLO	BLACK LINE
Hasta 70	529	582	598	658	718	790
70 - 100	565	622	639	703	767	843
100 - 130	620	682	701	771	841	925
130 - 160	657	723	743	817	891	980
160 - 180	694	764	784	863	941	1035

Características

- 2 puertas con apertura 180 °
- Espesor vidrio 6mm
- Tratamiento antical a dos caras
- Impresión digital, consultar pag:274
- Altura 1950. Máxima hasta 2200mm
- Cierre magnético
- Ancho máximo de la puerta 900mm

Opciones				
Cambio de tirador por pomo +60	En bañera, h=1500 al mismo precio	Incremento altura, +5% cada 5 cm	Recortes especiales en el vidrio, +90	Impresión digital personalizada, ver pag:274





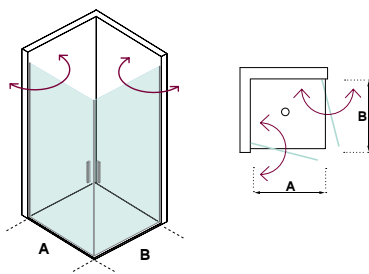

ST2AR



Rango de medida A+B	G0 Transparente		G1 Mate, Extraclaro, Gris, Bronce		G2 Espejo, Negro	
	B BRILLO	N BLACK LINE	B BRILLO	N BLACK LINE	B BRILLO	N BLACK LINE
Hasta 140	664	731	751	826	901	991
140 - 160	696	766	787	865	944	1039
160 - 180	714	785	807	887	968	1065

Características

-  2 puertas batientes a 180°
-  Espesor vidrio 6mm
-  Tratamiento antical a dos caras
-  Impresión digital, consultar pag:274
-  Altura 1950. Máxima hasta 2200mm
-  Cierre magnético
-  Ancho máximo de la puerta 900mm

Opciones

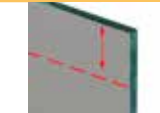
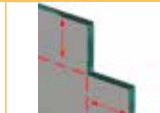
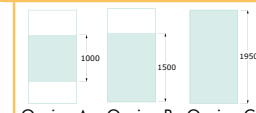
Cambio de tirador por pomo +60	En bañera, h=1500 al mismo precio	Incremento altura, +5% cada 5 cm	Recortes especiales en el vidrio, +90	Impresión digital personalizada, ver pag:274
				 Opcion A Opcion B Opcion C



ST3A

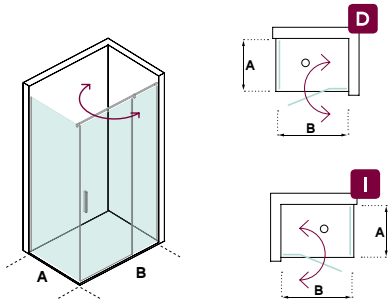

Características

- 2 puertas con apertura 180 °
- Espesor vidrio 6mm
- Tratamiento antical a dos caras
- Impresión digital, consultar pag:274
- Altura 1950. Máxima hasta 2200mm
- Cierre magnético
- Ancho máximo de la puerta 900mm

Rango de medida A+B	G0 Transparente		G1 Mate, Extraclaro, Gris, Bronce		G2 Espejo, Negro	
	B BRILLO	BLACK LINE	B BRILLO	BLACK LINE	B BRILLO	BLACK LINE
Hasta 160	710	781	802	883	963	1059
160 - 180	734	808	830	913	996	1095
180 - 200	755	831	854	939	1024	1127
200 - 220	789	868	892	981	1070	1177
220 - 240	813	895	919	1011	1103	1213
240 - 260	904	994	1021	1123	1226	1348
260 - 280	948	1043	1072	1179	1286	1415

Opciones				
Cambio de tirador por pomo+30	En bañera, h=1500 al mismo precio	Incremento altura, +5% cada 5 cm	Recortes especiales en el vidrio, +90	Impresión digital personalizada, ver pag:274



STAR



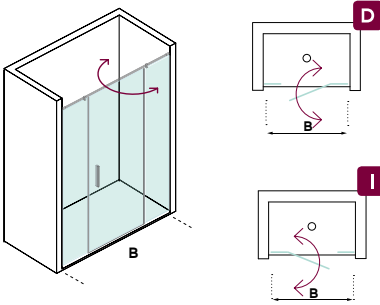

ST3



Rango de medida B	G0 Transparente		G1 Mate, Extraclaro, Gris, Bronce		G2 Espejo, Negro	
	B BRILLO	N BLACK LINE	B BRILLO	N BLACK LINE	B BRILLO	N BLACK LINE
Hasta 120	599	659	677	745	812	894
120 - 140	625	688	706	777	848	932
140 - 160	673	741	761	837	913	1004
160 - 180	691	760	780	858	936	1030
180 - 200	719	791	813	894	975	1073

Características

-  2 fijos y 1 puerta batiente a 180°
-  Espesor vidrio 6mm
-  Tratamiento antical a dos caras
-  Impresión digital, consultar pag:274
-  Altura 1950. Máxima hasta 2200mm
-  Cierre magnético
-  Ancho máximo de la puerta 900mm

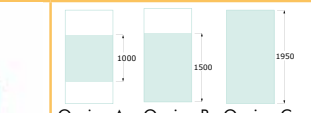
Opciones				
Cambio de tirador por pomo +30	En bañera, h=1500 al mismo precio	Incremento altura, +5% cada 5 cm	Recortes especiales en el vidrio, +90	Impresión digital personalizada, ver pag:274
				
				Opción A Opción B Opción C



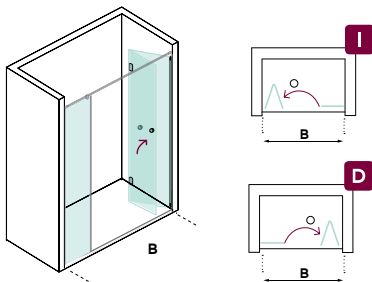

ST3PF



Rango de medida B	G0 Transparente		G1 Mate, Extraclaro, Gris, Bronce		G2 Espejo, Negro	
	B BRILLO	BLACK LINE	B BRILLO	BLACK LINE	B BRILLO	BLACK LINE
Hasta 120	689	758	778	856	934	1027
120- 140	737	811	833	916	999	1099
140 - 160	783	861	885	973	1062	1168

Características

-  1 fijo y 2 puertas plegables
-  Espesor vidrio 6mm
-  Tratamiento antical a dos caras
-  Impresión digital, consultar pag:274
-  Altura 1950. Máxima hasta 2200mm
-  Cierre magnético
-  Ancho máximo de la puerta 900mm

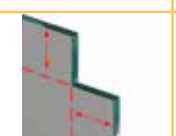
Opciones			
En bañera, h=1500 al mismo precio	Incremento altura, +5% cada 5 cm	Recortes especiales en el vidrio, +90	Impresión digital personalizada, ver pag:274
			 Opcion A Opcion B Opcion C







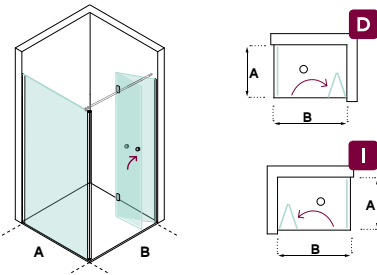

STAR

ST3AP





Rango de medida A+B	G0 Transparente		G1 Mate, Extraclaro, Gris, Bronce		G2 Espejo, Negro	
	B BRILLO	N BLACK LINE	B BRILLO	N BLACK LINE	B BRILLO	N BLACK LINE
Hasta 120	726	799	821	903	985	1083
120 - 140	750	825	847	932	1017	1118
140 - 160	776	854	877	965	1053	1158
160 - 180	800	880	904	994	1085	1193
180 - 200	826	909	934	1027	1120	1233

Características

-  1 fijos y 2 puertas plegables
-  Espesor vidrio 6mm
-  Tratamiento antical a dos caras
-  Impresión digital, consultar pag:274
-  Altura 1950. Máxima hasta 2200mm
-  Cierre magnético
-  Ancho máximo de la puerta 900mm

Opciones

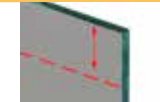
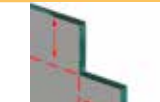
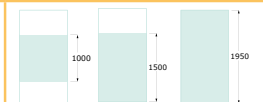
Cambio de tirador por pomo+30	En bañera,h=1500 al mismo precio	Incremento altura, +5% cada 5 cm	Recortes especiales en el vidrio, +90	Impresión digital personalizada,ver pag:274
				
				Opcion A Opcion B Opcion C





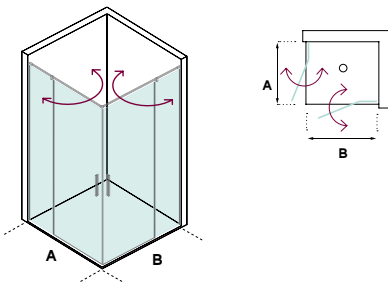







ST4A



Rango de medida A+B	G0 Transparente		G1 Mate, Extraclaro, Gris, Bronce		G2 Espejo, Negro	
	B BRILLO	BLACK LINE	B BRILLO	BLACK LINE	B BRILLO	BLACK LINE
Hasta 160	845	929	954	1050	1145	1260
160- 180	873	960	987	1085	1184	1302
180 - 200	902	992	1019	1121	1223	1345
200- 220	927	1020	1048	1153	1258	1383

Características

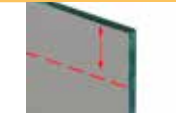
-  1 fijo y 2 puertas batientes
-  Espesor vidrio 6mm
-  Tratamiento antical a dos caras
-  Impresión digital, consultar pag:274
-  Altura 1950. Máxima hasta 2200mm
-  Cierre magnético
-  Ancho máximo de la puerta 900mm

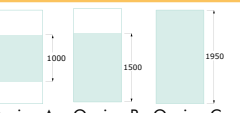
Opciones				
Cambio de tirador por pomo+60	En bañera,h= 1500 al mismo precio	Incremento altura, +5% cada 5 cm	Recortes especiales en el vidrio, +90	Impresión digital personalizada,ver pag:274
				
				Opcion A Opcion B Opcion C



ST4

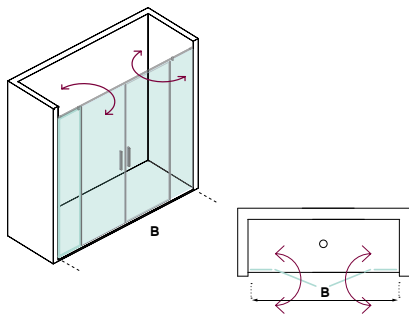

Rango de medida B	G0 Transparente		G1 Mate, Extraclaro, Gris, Bronce		G2 Espejo, Negro	
	B BRILLO	N BLACK LINE	B BRILLO	N BLACK LINE	B BRILLO	N BLACK LINE
Hasta 140	797	877	901	991	1081	1189
140 - 160	822	904	929	1022	1115	1226
160 - 180	850	935	960	1056	1153	1268
180 - 200	878	966	992	1091	1190	1309
200 - 220	903	993	1020	1122	1224	1347

Características

-  2 fijos y 2 puertas batientes a 180°
-  Espesor vidrio 6mm
-  Tratamiento antical a dos caras
-  Impresión digital, consultar pag:274
-  Altura 1950. Máxima hasta 2200mm
-  Cierre magnético
-  Ancho máximo de la puerta 900mm

Opciones

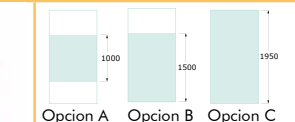
Cambio de tirador por pomo+60	En bañera, h=1500 al mismo precio	Incremento altura, +5% cada 5 cm	Recortes especiales en el vidrio, +90	Impresión digital personalizada, ver pag:274
				
				Opción A Opción B Opción C



ST4AP

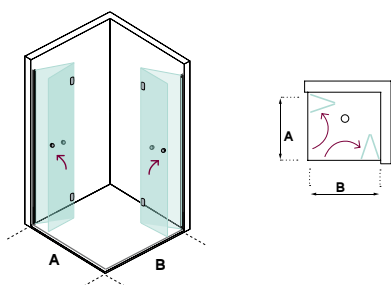

Rango de medida A+B	G0 Transparente		G1 Mate, Extraclaro, Gris, Bronce		G2 Espejo, Negro	
	B BRILLO	BLACK LINE	B BRILLO	BLACK LINE	B BRILLO	BLACK LINE
Hasta 140	849	934	959	1055	1151	1266
140 - 160	882	970	996	1096	1196	1315
160 - 180	915	1006	1034	1137	1240	1364

Características

-  4 puertas plegables
-  Espesor vidrio 6mm
-  Tratamiento antical a dos caras
-  Impresión digital, consultar pag:274
-  Altura 1950. Máxima hasta 2200mm
-  Cierre magnético
-  Ancho máximo de la puerta 900mm

Opciones			
En bañera, h=1500 al mismo precio	Incremento altura, +5% cada 5 cm	Recortes especiales en el vidrio, +90	Impresión digital personalizada, ver pag:274
			 Opcion A Opcion B Opcion C

HANDI

HANDI



HN2

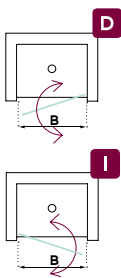
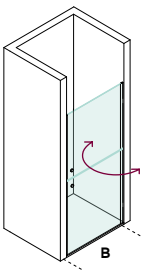

Rango de medida B	G0 Transparente	G1 Mate, Extraclaro, Gris, Bronce	G2 Espejo, Negro
	Hasta 70	621	701
70 - 90	652	737	884

Características

-  2 puertas batientes a 180°
-  Espesor vidrio 6mm
-  Tratamiento antical a dos caras
-  Impresión digital, consultar pag:274
-  Altura 1950. Máxima hasta 2100mm
-  Cierre magnético
-  Ancho máximo de la puerta 900mm

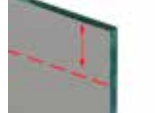
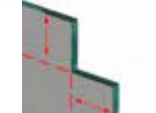
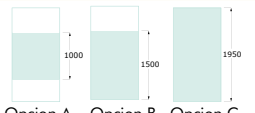
Opciones		
Incremento altura, +5% cada 5 cm	Recortes especiales en el vidrio, +90	Impresión digital personalizada, ver pag:274
		



HN4A

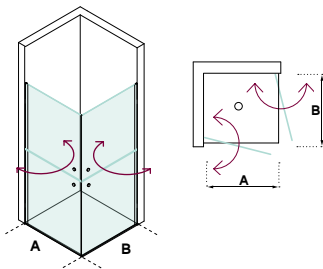

Rango de medida A + B	G0 Transparente	G1 Mate, Extraclaro, Gris, Bronce	G2 Espejo, Negro
	B BRILLO	B BRILLO	B BRILLO
Hasta 140	1068	1207	1449
140 - 160	1103	1246	1495
160 - 180	1120	1265	1518
180 - 200	1148	1297	1557

Características

- 4 puertas batientes a 180°
- Espesor vidrio 6mm
- Tratamiento antical a dos caras
- Impresión digital, consultar pag:274
- Altura 1950. Máxima hasta 2100mm
- Cierre magnético
- Ancho máximo de la puerta 900mm

Opciones		
Incremento altura, +5% cada 5 cm	Recortes especiales en el vidrio, +90	Impresión digital personalizada, ver pag:274
		 Opcion A Opcion B Opcion C

HANDI

HANDI





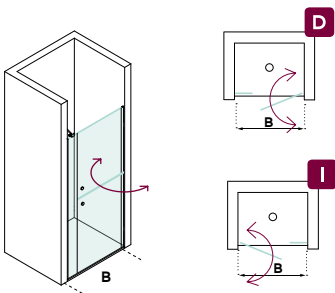

HN3



Rango de medida B	G0 Transparente	G1 Mate, Extraclaro, Gris, Bronce	G2 Espejo, Negro
	B BRILLO	B BRILLO	B BRILLO
Hasta 100	761	860	1032
100 - 130	797	900	1081
130 - 160	835	944	1133

Características

-  1 fijo y 2 puertas batientes a 180°
-  Espesor vidrio 6mm
-  Tratamiento antical a dos caras
-  Impresión digital, consultar pag:274
-  Altura 1950. Máxima hasta 2100mm
-  Cierre magnético
-  Ancho máximo de la puerta 900mm

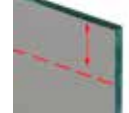
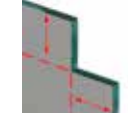
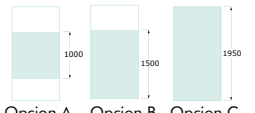
Opciones		
Incremento altura, +5% cada 5 cm	Recortes especiales en el vidrio, +90	Impresión digital personalizada, ver pag:274
		 Opcion A Opcion B Opcion C



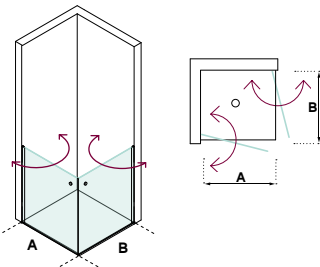

HN2A



Rango de medida A + B	G0 Transparente	G1 Mate, Extraclaro, Gris, Bronce	G2 Espejo, Negro
	B BRILLO	B BRILLO	B BRILLO
Hasta 140	624	705	847
140 - 160	637	720	864
160 - 180	650	735	881
180 - 200	669	756	907

Características

-  2 puertas batientes a 180°
-  Espesor vidrio 6mm
-  Tratamiento antical a dos caras
-  Impresión digital, consultar pag:274
-  Altura 1950. Máxima hasta 2100mm
-  Cierre magnético
-  Ancho máximo de la puerta 900mm

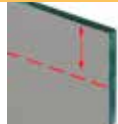
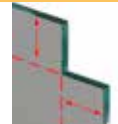
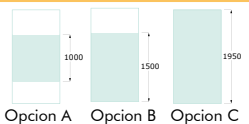
Opciones		
Incremento altura, +5% cada 5 cm	Recortes especiales en el vidrio, +90	Impresión digital personalizada, ver pag:274
		 <p>Opcion A Opcion B Opcion C</p>

FLEX

FLEX



• Brazo largo de refuerzo en acero



• Perfil lateral en aluminio brillo



• Brazo corto para vidrios menores de 40cm



• Bisagras en acero



• Pomo cónico metálico



• Tirador metálico

- B BRILLO
- B BRILLO
- B BRILLO
- B BRILLO
- BLACK LINE
- B BRILLO
- B BRILLO
- BLACK LINE
- B BRILLO
- B BRILLO
- M MATEADO
- B BRILLO
- M MATEADO
- B BRILLO
- M MATEADO
- BLACK LINE
- B BRILLO
- B BRILLO
- BLACK LINE
- B BRILLO
- BLACK LINE
- B BRILLO
- BLACK LINE
- B BRILLO
- BLACK LINE
- B BRILLO
- BLACK LINE
- B BRILLO
- BLACK LINE
- B BRILLO
- M MATEADO
- B BRILLO
- M MATEADO
- BLACK LINE
- B BRILLO
- B BRILLO
- M MATEADO
- BLACK LINE
- M MATEADO
- BLACK LINE
- M MATEADO
- BLACK LINE
- B BRILLO
- M MATEADO
- BLACK LINE
- B BRILLO
- C COBRE
- BLACK LINE
- B BRILLO

- SOLID
- SIDE
- MOON
- STAR
- WALL
- SOLID
- SIDE
- MOON
- SUITE
- PASS
- DUNE
- FORUM
- NEXUS
- INFINITI
- ROLLING
- COMBI
- STAR
- HANDI
- FLEX
- NOVA
- OPEN
- QUADRO
- NATURE
- STYLE
- NEXUS
- TECHNICAL
- ROLLING
- INVISIBLE
- FRAME
- CASSONETTO
- CLICK
- PACK
- HIDRA
- DATOS TÉCNICOS
- DECORADOS

FLEX

FLEX



FLEX

FLI

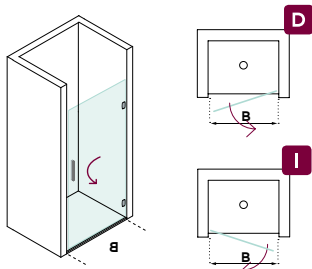

Rango de medida B	G0 Transparente	G1 Mate, Extraclaro, Gris, Bronce	G2 Espejo, Negro
		B BRILLO	B BRILLO
Hasta 70	395	446	474
70 - 80	415	499	540
80 - 90	439	527	570

Hasta 70	454	513	544
70 - 80	478	573	621
80 - 90	504	605	656

Características

- 1 puerta con apertura 90°
- Espesor vidrio 6 mm
- Espesor vidrio 8 mm
- Tratamiento antical a dos caras
- Impresión digital, consultar pag:274
- Altura 1950. Máxima hasta 2200mm
- Cierre magnético
- Ancho máximo de la puerta 900mm

Opciones

Cambio de tirador por pomo+30	Incremento altura, +5% cada 5 cm	Recortes especiales en el vidrio, +90	Impresión digital personalizada, ver pag:274



FL2

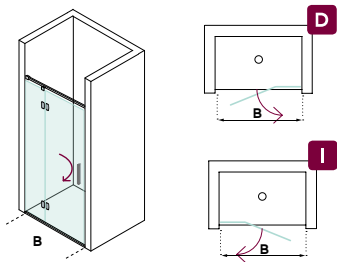

Rango de medida B	G0 Transparente	G1 Mate, Extraclaro, Gris, Bronce	G2 Espejo, Negro
		B BRILLO	B BRILLO
Hasta 80	519	586	622
80 - 100	544	615	653
100 - 120	567	640	680
120 - 140	603	681	724
140 - 160	646	730	775

Hasta 80	596	674	715
80 - 100	626	707	751
100 - 120	651	736	782
120 - 140	693	783	832
140 - 160	743	839	891

Características

- 1 puerta solapada con apertura 90°
- Espesor vidrio 6 mm
- Espesor vidrio 8 mm
- Tratamiento antical a dos caras
- Impresión digital, consultar pag:274
- Altura 1950. Máxima hasta 2200mm
- Cierre magnético
- Ancho máximo de la puerta 900mm

Opciones

Cambio de tirador por pomo+30	Incremento altura, +5% cada 5 cm	Recortes especiales en el vidrio, +90	Impresión digital personalizada, ver pag:274



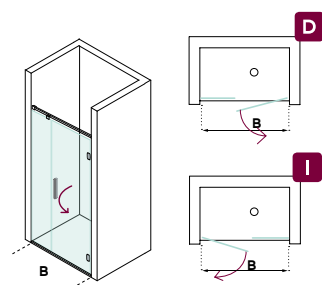

FL2F



Características

-  1 fijo y 1 puerta con apertura 90°
-  Espesor de vidrio 6 mm
-  Espesor de vidrio 8 mm
-  Tratamiento antical a dos caras
-  Impresión digital, consultar pag:274
-  Altura 1950. Máxima hasta 2200mm
-  Cierre magnético
-  Ancho máximo de la puerta 900mm



Rango de medida B	G0 Transparente	G1 Mate, Extraclaro, Gris, Bronce	G2 Espejo, Negro
			
Hasta 80	497	562	597
80 - 100	525	594	630
100 - 120	546	617	656
120 - 140	585	661	702
140 - 160	623	704	748

Hasta 80	572	646	686
80 - 100	604	682	725
100 - 120	628	710	754
120 - 140	672	760	807
140 - 160	716	809	860

Opciones

Cambio de tirador por pomo +30	Incremento altura, +5% cada 5 cm	Recortes especiales en el vidrio, +90	Impresión digital personalizada, ver pag:274
			



FL2R

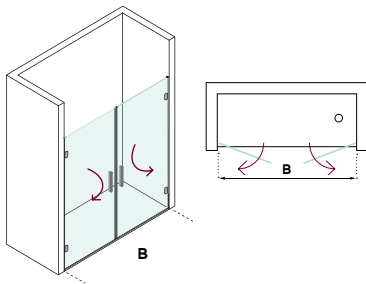

Características

- 2 puertas con apertura 90°
- Espesor vidrio 6 mm
- Espesor vidrio 8 mm
- Tratamiento antical a dos caras
- Impresión digital, consultar pag:274
- Altura 1950. Máxima hasta 2200mm
- Cierre magnético
- Ancho máximo de la puerta 900mm

Rango de medida B	G0 Transparente	G1 Mate, Extraclaro, Gris, Bronce	G2 Espejo, Negro
Hasta 100	631	713	757
100 - 120	653	784	849
120 - 140	696	836	905
140 - 160	735	882	955
160 - 180	782	938	1016

Hasta 100	725	820	870
100 - 120	751	901	976
120 - 140	800	960	1040
140 - 160	845	1014	1098
160 - 180	899	1078	1168

Opciones

Cambio de tirador por pomo+60	Incremento altura, +5% cada 5 cm	Recortes especiales en el vidrio, +90	Impresión digital personalizada, ver pag:274



FL2AR

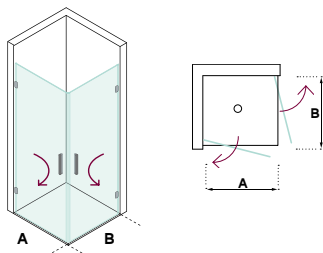

Rango de medida A + B	G0 Transparente	G1 Mate, Extraclaro, Gris, Bronce	G2 Espejo, Negro
		B BRILLO	B BRILLO
Hasta 160	730	825	876
160 - 180	776	877	931



Hasta 160	839	948	1007
160 - 180	892	1008	1070

Características

-  2 puertas con apertura 90°
-  Espesor de vidrio 6 mm
-  Espesor de vidrio 8 mm
-  Tratamiento antical a dos caras
-  Impresión digital, consultar pag:274
-  Altura 1950. Máxima hasta 2200mm
-  Cierre magnético
-  Ancho máximo de la puerta 900mm

Opciones

Cambio de tirador por pomo+60	Incremento altura, +5% cada 5 cm	Recortes especiales en el vidrio, +90	Impresión digital personalizada, ver pag:274
			
			Opcion A Opcion B Opcion C





FLEX

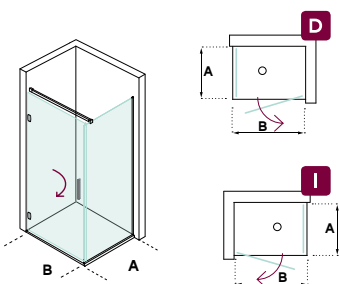

FL2A



Características

-  1 puerta y 1 fijo lateral
-  Espesor vidrio 6 mm
-  Espesor vidrio 8 mm
-  Tratamiento anticorrosión a dos caras
-  Impresión digital, consultar pag:274
-  Altura 1950. Máxima hasta 2200mm
-  Cierre magnético
-  Ancho máximo de la puerta 900mm



Rango de medida A + B	G0 Transparente	G1 Mate, Extraclaro, Gris, Bronce	G2 Espejo, Negro
			
Hasta 160	672	759	806
160 - 180	710	802	852
180 - 200	751	849	902
200 - 220	789	892	947

Hasta 160	772	873	927
160 - 180	816	922	979
180 - 200	864	976	1036
200 - 220	907	1025	1089

Opciones

Cambio de tirador por pomo+30	Incremento altura, +5% cada 5 cm	Recortes especiales en el vidrio, +90	Impresión digital personalizada, ver pag:274
			 <p>Opción A Opción B Opción C</p>



FL2P

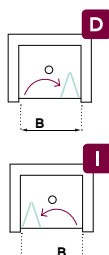
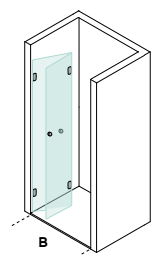

Rango de medida B	G0 Transparente	G1 Mate, Extraclaro, Gris, Bronce	G2 Espejo, Negro
		B BRILLO	B BRILLO
Hasta 70	562	635	674
70 - 80	603	723	783
80 - 90	640	768	832



Hasta 70	646	730	775
70 - 80	693	831	901
80 - 90	735	882	956

Características

- 2 puertas plegables a interior
- Espesor de vidrio 6 mm
- Espesor de vidrio 8 mm
- Tratamiento antical a dos caras
- Impresión digital, consultar pag:274
- Altura 1950. Máxima hasta 2200mm
- Cierre magnético
- Ancho máximo de la puerta 900mm

Opciones		
Incremento altura, +5% cada 5 cm	Recortes especiales en el vidrio, +90	Impresión digital personalizada, ver pag:274
Opcion A	Opcion B	Opcion C



FLEX

FL3P

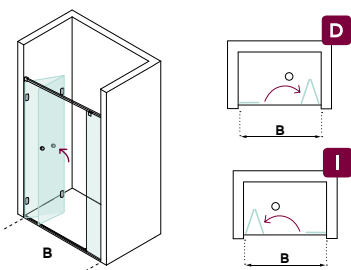

Características

-  1 Fijo y 2 puertas plegables a interior
-  Espesor vidrio 6 mm
-  Espesor vidrio 8 mm
-  Tratamiento antical a dos caras
-  Impresión digital, consultar pag:274
-  Altura 1950. Máxima hasta 2200mm
-  Cierre magnético
-  Ancho máximo de la puerta 900mm

Rango de medida B	G0 Transparente	G1 Mate, Extraclaro, Gris, Bronce	G2 Espejo, Negro
		B BRILLO	B BRILLO
Hasta 120	734	829	881
120 - 140	766	865	919
140 - 160	790	893	948
160 - 180	834	942	1000

Hasta 120	843	953	1012
120 - 140	880	995	1056
140 - 160	908	1026	1090
160 - 180	958	1083	1150

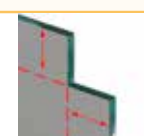
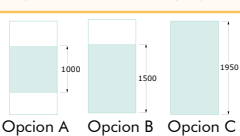



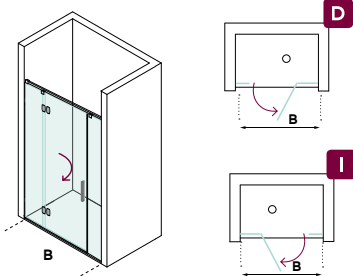

Opciones		
Incremento altura, +5% cada 5 cm	Recortes especiales en el vidrio, +90	Impresión digital personalizada, ver pag:274
		





FL3



Características

-  2 fijos y 1 puerta con apertura 90°
-  Espesor de vidrio 6 mm
-  Espesor de vidrio 8 mm
-  Tratamiento antical a dos caras
-  Impresión digital, consultar pag:274
-  Altura 1950. Máxima hasta 2200mm
-  Cierre magnético
-  Ancho máximo de la puerta 900mm



Rango de medida B	G0 Transparente	G1 Mate, Extraclaro, Gris, Bronce	G2 Espejo, Negro
			
Hasta 120	722	816	867
120 - 140	753	851	904
140 - 160	770	870	924
160 - 180	786	888	943

Hasta 120	830	938	996
120 - 140	866	978	1039
140 - 160	885	1000	1062
160 - 180	903	1021	1084

Opciones

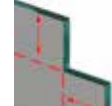
Cambio de tirador por pomo +30	Incremento altura, +5% cada 5 cm	Recortes especiales en el vidrio, +90	Impresión digital personalizada, ver pag:274
			 <p>Opcion A Opcion B Opcion C</p>



FL3A

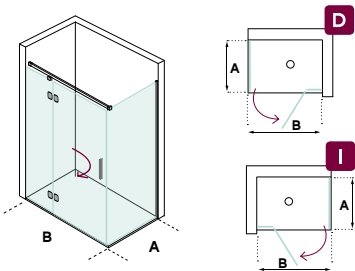



Características

-  2 Fijos y 1 puerta con apertura 90°
-  Espesor vidrio 6 mm
-  Espesor vidrio 8 mm
-  Tratamiento antical a dos caras
-  Impresión digital, consultar pag:274
-  Altura 1950. Máxima hasta 2200mm
-  Cierre magnético
-  Ancho máximo de la puerta 900mm

 6mm

 8mm

Rango de medida A + B	G0 Transparente	G1 Mate, Extraclaro, Gris, Bronce	G2 Espejo, Negro
		 BRILLO	 BRILLO
Hasta 180	761	860	913
180 - 200	784	885	940
200 - 220	820	927	985
220 - 240	850	961	1020

Hasta 180	875	988	1049
180 - 200	901	1018	1081
200 - 220	943	1066	1132
220 - 240	977	1104	1173

Opciones







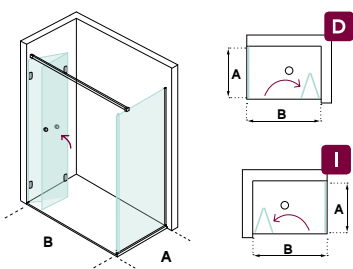

Cambio de tirador por pomo +30	Incremento altura, +5% cada 5 cm	Recortes especiales en el vidrio, +90	Impresión digital personalizada, ver pag:274
			 Opción A Opción B Opción C



FL3AP





Características

-  1 fijo y 2 puertas plegables
-  Espesor de vidrio 6 mm
-  Espesor de vidrio 8 mm
-  Tratamiento antical a dos caras
-  Impresión digital, consultar pag:274
-  Altura 1950. Máxima hasta 2200mm
-  Cierre magnético
-  Ancho máximo de la puerta 900mm



Rango de medida A + B	G0 Transparente	G1 Mate, Extraclaro, Gris, Bronce	G2 Espejo, Negro
			
Hasta 160	775	875	929
160 - 180	788	890	945
180 - 200	827	935	993
200 - 220	867	979	1040

Hasta 160	890	1006	1068
160 - 180	905	1023	1086
180 - 200	951	1074	1141
200 - 220	996	1126	1195

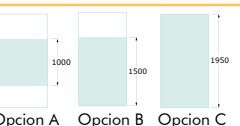
Opciones		
Incremento altura, +5% cada 5 cm	Recortes especiales en el vidrio, +90	Impresión digital personalizada, ver pag:274
		
		Opcion A Opcion B Opcion C



FL4

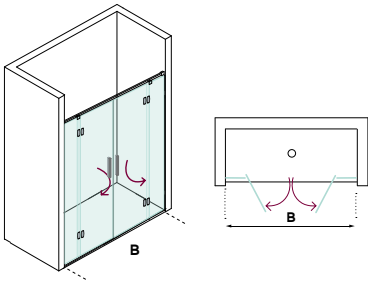

Características

-  2 Fijos y 2 puertas con apertura 90°
-  Espesor vidrio 6 mm
-  Espesor vidrio 8 mm
-  Tratamiento antical a dos caras
-  Impresión digital, consultar pag:274
-  Altura 1950. Máxima hasta 2200mm
-  Cierre magnético
-  Ancho máximo de la puerta 900mm

 6mm

 8mm

Rango de medida B	G0 Transparente	G1 Mate, Extraclaro, Gris, Bronce	G2 Espejo, Negro
			
Hasta 160	899	1016	1079
160 - 180	915	1034	1098
180 - 200	957	1082	1149
200 - 220	988	1117	1186

Hasta 160	1033	1168	1240
160 - 180	1052	1189	1263
180 - 200	1100	1243	1320
200 - 220	1136	1283	1363

Opciones

Cambio de tirador por pomo +60	Incremento altura, +5% cada 5 cm	Recortes especiales en el vidrio, +90	Impresión digital personalizada, ver pag:274
			 Opción A Opción B Opción C



FL4AP

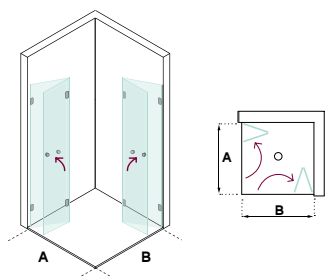

Rango de medida A + B	G0 Transparente	G1 Mate, Extraclaro, Gris, Bronce	G2 Espejo, Negro
		B BRILLO	B BRILLO
Hasta 160	985	1113	1182
160 - 180	1019	1151	1222



Hasta 160	1132	1279	1358
160 - 180	1171	1323	1405

Características

- 4 puertas plegables a interior
- Espesor de vidrio 6 mm
- Espesor de vidrio 8 mm
- Tratamiento antical a dos caras
- Impresión digital, consultar pag:274
- Altura 1950. Máxima hasta 2200mm
- Cierre magnético
- Ancho máximo de la puerta 900mm

Opciones		
Incremento altura, +5% cada 5 cm	Recortes especiales en el vidrio, +90	Impresión digital personalizada, ver pag:274
		Opcion A Opcion B Opcion C



FLEX

FL4A

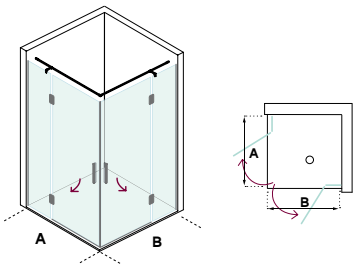

Características

-  2 Fijos y 2 puertas con apertura 90°
-  Espesor vidrio 6 mm
-  Espesor vidrio 8 mm
-  Tratamiento antical a dos caras
-  Impresión digital, consultar pag:274
-  Altura 1950. Máxima hasta 2200mm
-  Cierre magnético
-  Ancho máximo de la puerta 900mm

Rango de medida A + B	G0 Transparente	G1 Mate, Extraclaro, Gris, Bronce	G2 Espejo, Negro
			
Hasta 160	925	1045	1110
160 - 180	941	1063	1129
180 - 200	983	1110	1179
200 - 220	1013	1145	1216



Hasta 160	1063	1201	1276
160 - 180	1082	1222	1298
180 - 200	1129	1276	1355
200 - 220	1165	1316	1398



Opciones

Cambio de tirador por pomo+60	Incremento altura, +5% cada 5 cm	Recortes especiales en el vidrio, +90	Impresión digital personalizada, ver pag:274
			 Opción A Opción B Opción C

NOVA

NOVA



• Brazo largo de refuerzo en acero



• Perfil lateral en aluminio brillo



• Brazo corto para vidrios menores de 40cm

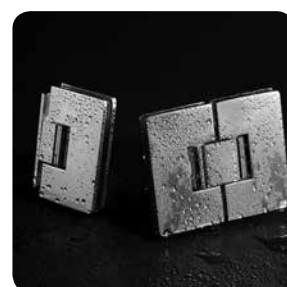

• Bisagras cromadas



• Pomo cónico metálico



• Tirador metálico

- BRILLO
- BRILLO
- BRILLO
- BRILLO
- BLACK LINE
- BRILLO
- BRILLO
- BLACK LINE
- BRILLO
- BRILLO
- MATEADO
- BRILLO
- MATEADO
- BRILLO
- MATEADO
- BLACK LINE
- BRILLO
- BRILLO
- BRILLO
- BLACK LINE
- BRILLO
- BLACK LINE
- BRILLO
- BRILLO
- BLACK LINE
- BRILLO
- BLACK LINE
- BRILLO
- MATEADO
- MATEADO
- BLACK LINE
- BRILLO
- BRILLO
- MATEADO
- MATEADO
- BLACK LINE
- MATEADO
- BLACK LINE
- MATEADO
- BLACK LINE
- BRILLO
- MATEADO
- BLACK LINE
- BRILLO
- COBRE
- BLACK LINE
- BRILLO

- SOLID
- SIDE
- MOON
- STAR
- WALL
- SOLID
- SIDE
- MOON
- SUITE
- PASS
- DUNE
- FORUM
- NEXUS
- INFINITI
- ROLLING
- COMBI
- STAR
- HANDI
- FLEX
- NOVA
- OPEN
- QUADRO
- NATURE
- STYLE
- NEXUS
- TECHNICAL
- ROLLING
- INVISIBLE
- FRAME
- CASSONETTO
- CLICK
- PACK
- HIDRA
- DATOS TÉCNICOS
- DECORADOS

NOVA

NOVA







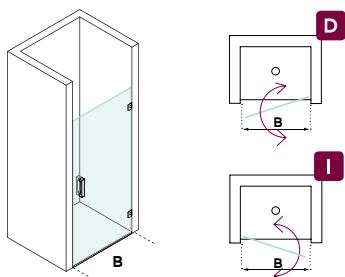

NOVA

NVI





Características

-  1 puerta con apertura 180°
-  Espesor de vidrio 8 mm
-  Tratamiento antical a dos caras
-  Impresión digital, consultar pag:274
-  Altura 1950. Máxima hasta 2200mm
-  Cierre magnético
-  Ancho máximo de la puerta 900mm

Rango de medida B	G0 Transparente		G1 Mate, Extraclaro, Gris, Bronce		G2 Espejo, Negro	
	 BRILLO	 BLACK LINE	 BRILLO	 BLACK LINE	 BRILLO	 BLACK LINE
Hasta 70	456	525	516	593	548	630
70 - 90	471	542	532	612	565	650

Opciones

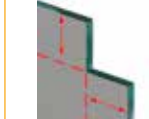
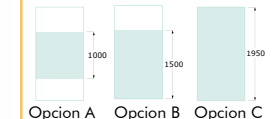
Cambio de tirador por pomo+30	En bañera, h=1500 al mismo precio	Incremento altura, +5% cada 5 cm	Recortes especiales en el vidrio, +90	Impresión digital personalizada, ver pag:274
				



NV2

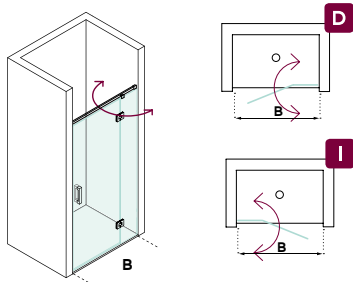

Rango de medida B	G0 Transparente		G1 Mate, Extraclaro, Gris, Bronce		G2 Espejo, Negro	
	B BRILLO	BLACK LINE	B BRILLO	BLACK LINE	B BRILLO	BLACK LINE
Hasta 80	590	747	667	844	709	896
80 - 100	605	765	684	865	726	919
100 - 120	632	800	715	904	759	960
120 - 140	655	828	740	936	786	994

Características

- 1 fijo y 1 puerta con apertura 180 °
- Espesor de vidrio 8 mm
- Tratamiento antical a dos caras
- Impresión digital, consultar pag:274
- Altura 1950. Máxima hasta 2200mm
- Cierre magnético
- Ancho máximo de la puerta 900mm

Opciones

Cambio de tirador por pomo+30	En bañera,h=1500 al mismo precio	Incremento altura, +5% cada 5 cm	Recortes especiales en el vidrio, +90	Impresión digital personalizada,ver pag:274

NOVA



NOVA

NV2F

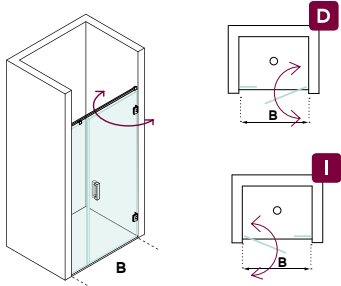

Características

- 1 Fijo y 1 puerta con apertura 180 °
- Espesor de vidrio 8 mm
- Tratamiento antical a dos caras
- Impresión digital, consultar pag:274
- Altura 1950. Máxima hasta 2200mm
- Cierre magnético
- Ancho máximo de la puerta 900mm

Rango de medida B	G0 Transparente		G1 Mate, Extraclaro, Gris, Bronce		G2 Espejo, Negro	
	BRILLO	BLACK LINE	BRILLO	BLACK LINE	BRILLO	BLACK LINE
Hasta 80	565	650	639	735	679	780
80 - 100	599	689	677	779	719	827
100 - 120	640	736	723	831	768	883
120 - 140	655	753	740	851	786	904
140 - 160	679	780	767	882	814	936
160 - 180	715	823	808	930	859	987

Opciones

Cambio de tirador por pomo+30	En bañera, h=1500 al mismo precio	Incremento altura, +5% cada 5 cm	Recortes especiales en el vidrio, +90	Impresión digital personalizada, ver pag:274
				Opción A Opción B Opción C

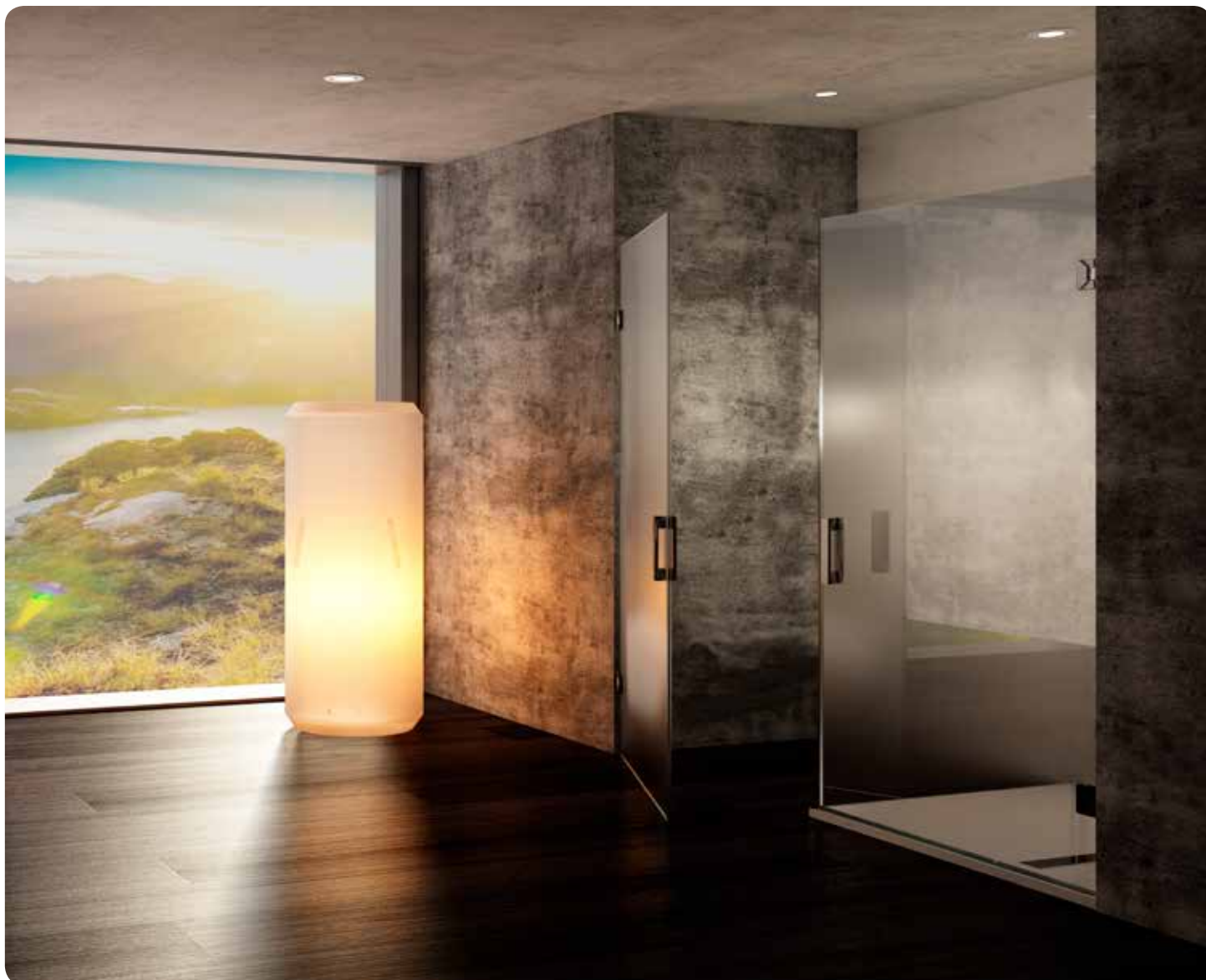

NV2R

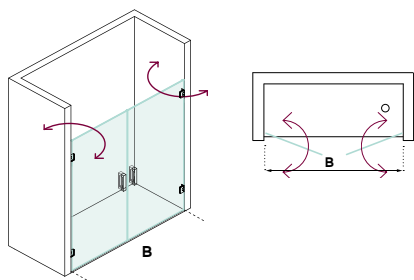

Rango de medida B	G0 Transparente		G1 Mate, Extraclaro, Gris, Bronce		G2 Espejo, Negro	
	B BRILLO	BLACK LINE	B BRILLO	BLACK LINE	B BRILLO	BLACK LINE
Hasta - 100	724	832	818	941	869	999
100 - 120	748	860	845	972	898	1033
120 - 140	783	901	885	1018	940	1081
140 - 160	819	942	926	1065	983	1131
160 - 180	864	994	976	1123	1037	1192

Características

- 2 puertas con apertura 180°
- Espesor de vidrio 8 mm
- Tratamiento antical a dos caras
- Impresión digital, consultar pag:274
- Altura 1950. Máxima hasta 2200mm
- Cierre magnético
- Ancho máximo de la puerta 900mm

Opciones

Cambio de tirador por pomo+60	En bañera, h=1500 al mismo precio	Incremento altura, +5% cada 5 cm	Recortes especiales en el vidrio, +90	Impresión digital personalizada, ver pag:274





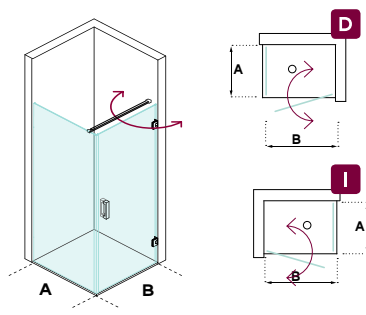







NV2A



Características

-  1 Fijo y 1 puerta con apertura 180 °
-  Espesor de vidrio 8 mm
-  Tratamiento antical a dos caras
-  Impresión digital, consultar pag:274
-  Altura 1950. Máxima hasta 2200mm
-  Cierre magnético
-  Ancho máximo de la puerta 900mm

Rango de medida A + B	G0 Transparente		G1 Mate, Extraclaro, Gris, Bronce		G2 Espejo, Negro	
	 BRILLO	 BLACK LINE	 BRILLO	 BLACK LINE	 BRILLO	 BLACK LINE
Hasta 140	671	772	758	872	805	926
140 - 160	693	797	783	901	832	956
160 - 180	695	800	786	904	834	960

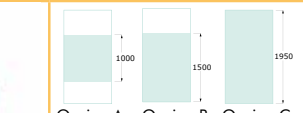
Opciones				
Cambio de tirador por pomo+30	En bañera, h=1500 al mismo precio	Incremento altura, +5% cada 5 cm	Recortes especiales en el vidrio, +90	Impresión digital personalizada, ver pag:274
				
				Opción A Opción B Opción C

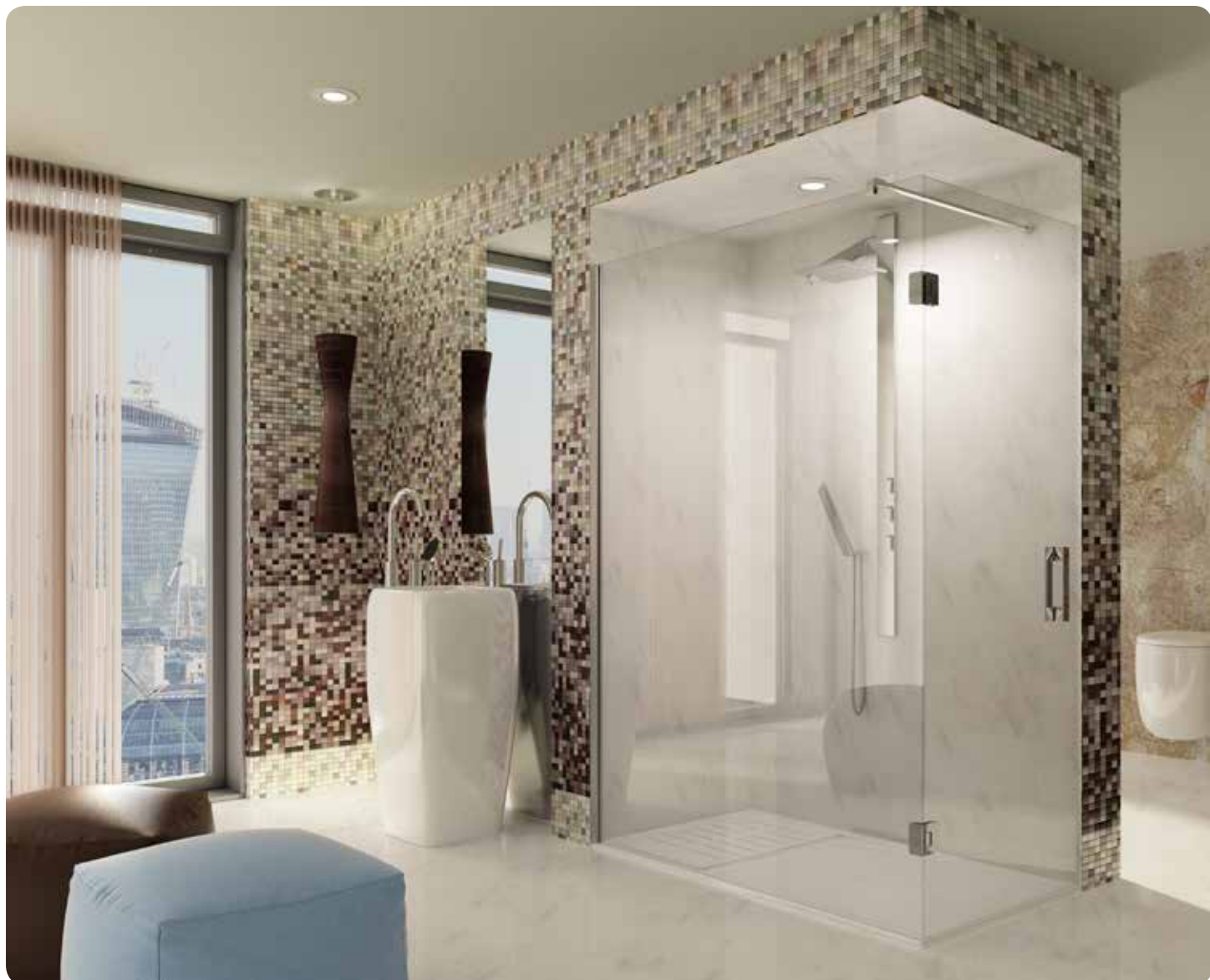

NV2AM

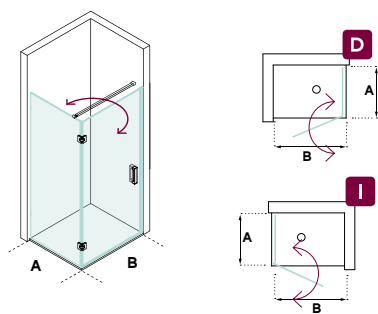

Rango de medida A + B	G0 Transparente		G1 Mate, Extraclaro, Gris, Bronce		G2 Espejo, Negro	
	BRILLO	BLACK LINE	BRILLO	BLACK LINE	BRILLO	BLACK LINE
Hasta 160	843	970	953	1096	1012	1164
160 - 180	861	990	973	1119	1033	1188
180 - 200	881	1014	996	1145	1058	1216

Características

- 1 Fijo y 1 puerta con apertura 180 °
- Espesor de vidrio 8 mm
- Tratamiento antical a dos caras
- Impresión digital, consultar pag:274
- Altura 1950. Máxima hasta 2200mm
- Cierre magnético
- Ancho máximo de la puerta 900mm

Opciones

Cambio de tirador por pomo+30	En bañera, h=1500 al mismo precio	Incremento altura, +5% cada 5 cm	Recortes especiales en el vidrio, +90	Impresión digital personalizada, ver pag:274



NV2AR

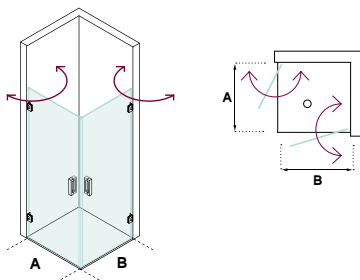



Rango de medida A + B	G0 Transparente		G1 Mate, Extraclaro, Gris, Bronce		G2 Espejo, Negro	
	B BRILLO	N BLACK LINE	B BRILLO	N BLACK LINE	B BRILLO	N BLACK LINE
Hasta 120	749	861	846	973	899	1034
120 - 140	783	901	885	1018	940	1081
140 - 160	820	943	927	1066	984	1132
160 - 180	864	994	976	1123	1037	1192

Características

-  2 puertas con apertura 180 °
-  Espesor de vidrio 8 mm
-  Tratamiento antical a dos caras
-  Impresión digital, consultar pag:274
-  Altura 1950. Máxima hasta 2200mm
-  Cierre magnético
-  Ancho máximo de la puerta 900mm

Opciones

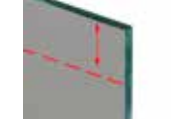
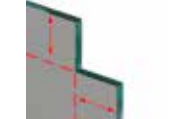
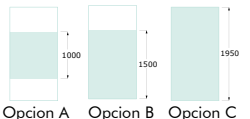
Cambio de tirador por pomo +60	En bañera, h=1500 al mismo precio	Incremento altura, +5% cada 5 cm	Recortes especiales en el vidrio, +90	Impresión digital personalizada, ver pag:274
				
				Opción A Opción B Opción C



NV2P

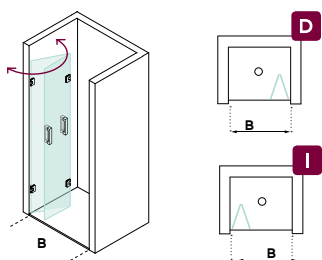

Rango de medida B	G0 Transparente		G1 Mate, Extraclaro, Gris, Bronce		G2 Espejo, Negro	
	B BRILLO	BLACK LINE	B BRILLO	BLACK LINE	B BRILLO	BLACK LINE
Hasta 80	766	969	866	1095	919	1163
80 - 100	781	988	882	1116	937	1185

Características

- 2 puertas plegables a 360°
- Espesor de vidrio 8 mm
- Tratamiento anticorrosion a dos caras
- Impresion digital, consultar pag:274
- Altura 1950. Máxima hasta 2200mm
- Cierre magnético
- Ancho máximo de la puerta 900mm

Opciones				
Cambio de tirador por pomo+60	En bañera,h=1500 al mismo precio	Incremento altura, +5% cada 5 cm	Recortes especiales en el vidrio, +90	Impresion digital personalizada,ver pag:274
				Opcion A Opcion B Opcion C





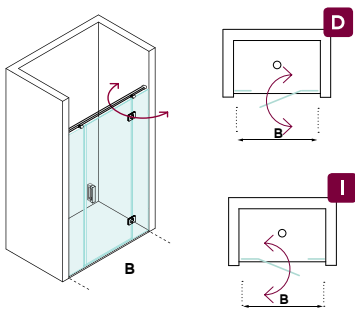



NV3





Características

-  2 fijos y 1 puerta con apertura 180°
-  Espesor de vidrio 8 mm
-  Tratamiento antical a dos caras
-  Impresión digital, consultar pag:274
-  Altura 1950. Máxima hasta 2200mm
-  Cierre magnético
-  Ancho máximo de la puerta 900mm

Rango de medida B	G0 Transparente		G1 Mate, Extraclaro, Gris, Bronce		G2 Espejo, Negro	
	 BRILLO	 BLACK LINE	 BRILLO	 BLACK LINE	 BRILLO	 BLACK LINE
Hasta 120	845	972	955	1098	1014	1166
120 - 140	860	989	972	1118	1032	1187
140 - 160	878	1009	992	1140	1053	1211
160 - 180	895	1029	1011	1163	1074	1235
180 - 200	932	1072	1053	1211	1119	1286

Opciones

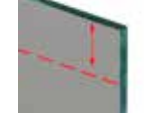
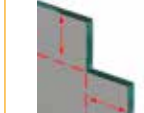
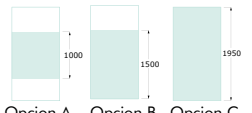
Cambio de tirador por pomo +30	En bañera, h=1500 al mismo precio	Incremento altura, +5% cada 5 cm	Recortes especiales en el vidrio, +90	Impresión digital personalizada, ver pag:274
				
				Opción A Opción B Opción C



NV3AP

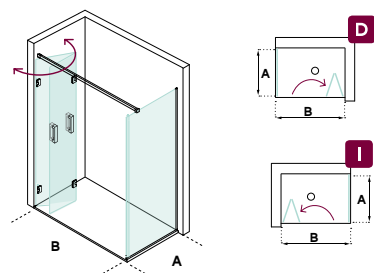

Rango de medida A + B	G0 Transparente		G1 Mate, Extraclaro, Gris, Bronce		G2 Espejo, Negro	
	BRILLO	BLACK LINE	BRILLO	BLACK LINE	BRILLO	BLACK LINE
Hasta 120	950	1093	1074	1235	1140	1312
120 - 140	967	1112	1093	1257	1161	1335
140 - 160	984	1132	1112	1279	1181	1358
160 - 180	1006	1156	1136	1307	1207	1388
180 - 200	1027	1181	1161	1335	1233	1418

Características

- 1 Fijo y 2 puertas plegables a 360 °
- Espesor de vidrio 8 mm
- Tratamiento antical a dos caras
- Impresión digital, consultar pag:274
- Altura 1950. Máxima hasta 2200mm
- Cierre magnético
- Ancho máximo de la puerta 900mm

Opciones				
Cambio de tirador por pomo+60	En bañera,h=1500 al mismo precio	Incremento altura, +5% cada 5 cm	Recortes especiales en el vidrio, +90	Impresión digital personalizada,ver pag:274



NV3AR

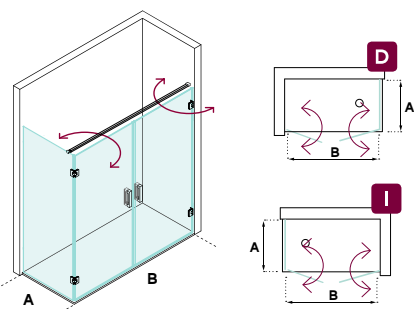

Características

- 1 fijo y 2 puertas con apertura 180°
- Espesor de vidrio 8 mm
- Tratamiento antical a dos caras
- Impresión digital, consultar pag:274
- Altura 1950. Máxima hasta 2200mm
- Cierre magnético
- Ancho máximo de la puerta 900mm

Rango de medida A + B	G0 Transparente		G1 Mate, Extraclaro, Gris, Bronce		G2 Espejo, Negro	
	BRILLO	BLACK LINE	BRILLO	BLACK LINE	BRILLO	BLACK LINE
Hasta 160	985	1133	1113	1280	1182	1359
160 - 200	1041	1198	1177	1353	1250	1437
200 - 240	1094	1258	1236	1422	1313	1510
240 - 280	1148	1320	1297	1491	1377	1584

Opciones

Cambio de tirador por pomo +60	En bañera, h=1500 al mismo precio	Incremento altura, +5% cada 5 cm	Recortes especiales en el vidrio, +90	Impresión digital personalizada, ver pag:274





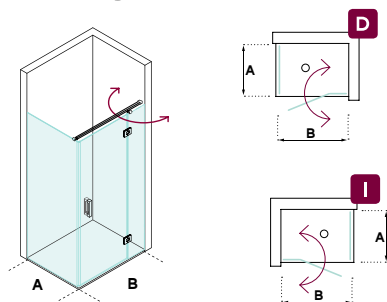





NV3A



Características

-  2 Fijos y 1 puerta con apertura a 180 °
-  Espesor de vidrio 8 mm
-  Tratamiento antical a dos caras
-  Impresión digital, consultar pag:274
-  Altura 1950. Máxima hasta 2200mm
-  Cierre magnético
-  Ancho máximo de la puerta 900mm

Rango de medida A + B	G0 Transparente		G1 Mate, Extraclaro, Gris, Bronce		G2 Espejo, Negro	
	 BRILLO	 BLACK LINE	 BRILLO	 BLACK LINE	 BRILLO	 BLACK LINE
Hasta 140	846	973	956	1099	1015	1167
124 - 160	864	993	976	1122	1036	1192
160 - 180	881	1014	996	1145	1058	1216
180 - 200	904	1040	1022	1175	1085	1248
200 - 220	927	1066	1048	1205	1113	1279
220 - 240	955	1098	1079	1241	1146	1318
240 - 260	983	1130	1111	1277	1180	1357
260 - 280	1008	1160	1139	1310	1210	1392

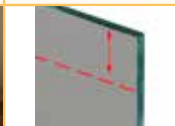
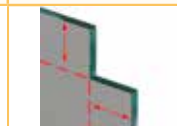
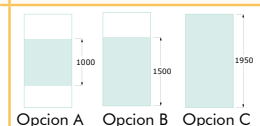
Opciones				
Cambio de tirador por pomo +30	En bañera, h=1500 al mismo precio	Incremento altura, +5% cada 5 cm	Recortes especiales en el vidrio, +90	Impresión digital personalizada, ver pag:274
				
				Opcion A Opcion B Opcion C

NOVA



NOVA

NV3AF

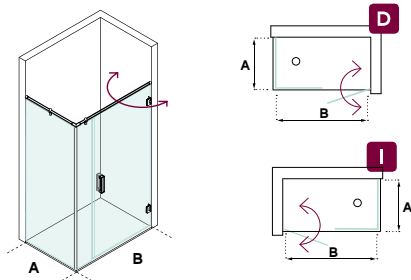

Rango de medida A + B	G0 Transparente		G1 Mate, Extraclaro, Gris, Bronce		G2 Espejo, Negro	
	BRILLO	BLACK LINE	BRILLO	BLACK LINE	BRILLO	BLACK LINE
Hasta 120	786	904	888	1022	943	1085
120 - 150	823	946	930	1069	988	1136
150 - 180	864	994	977	1123	1037	1193
180 - 200	896	1030	1013	1164	1075	1237
200 - 220	936	1077	1058	1217	1124	1292

Características

- 2 fijos y 1 puerta con apertura 180 °
- Espesor de vidrio 8 mm
- Tratamiento antical a dos caras
- Impresión digital, consultar pag:274
- Altura 1950. Máxima hasta 2200mm
- Cierre magnético
- Ancho máximo de la puerta 900mm

Opciones

Cambio de tirador por pomo+30	En bañera,h=1500 al mismo precio	Incremento altura, +5% cada 5 cm	Recortes especiales en el vidrio, +90	Impresión digital personalizada,ver pag:274



NV3AFL

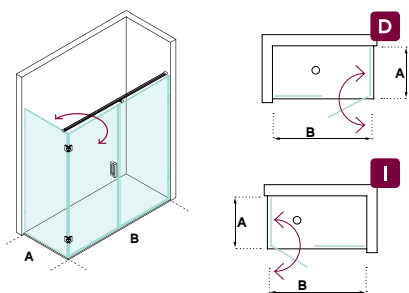



Características

-  2 Fijos y 1 puerta con apertura a 180°
-  Espesor de vidrio 8 mm
-  Tratamiento antical a dos caras
-  Impresión digital, consultar pag:274
-  Altura 1950. Máxima hasta 2200mm
-  Cierre magnético
-  Ancho máximo de la puerta 900mm

Rango de medida A + B	G0 Transparente		G1 Mate, Extraclaro, Gris, Bronce		G2 Espejo, Negro	
	B BRILLO	BLACK LINE	B BRILLO	BLACK LINE	B BRILLO	BLACK LINE
Hasta 140	870	1001	983	1131	1044	1201
140 - 160	888	1021	1003	1153	1065	1225
160 - 180	905	1041	1023	1176	1086	1249
180 - 200	928	1067	1048	1205	1113	1280
200 - 220	965	1110	1091	1254	1158	1332
220 - 240	998	1148	1128	1297	1198	1378
240 - 260	1035	1190	1169	1344	1241	1428
260 - 280	1068	1228	1207	1388	1282	1474

Opciones

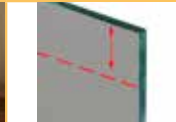
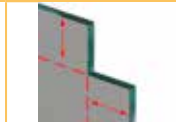
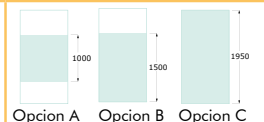
Cambio de tirador por pomo +30	En bañera, h=1500 al mismo precio	Incremento altura, +5% cada 5 cm	Recortes especiales en el vidrio, +90	Impresión digital personalizada, ver pag:274
				
				Opcion A Opcion B Opcion C



NOVA

NV4

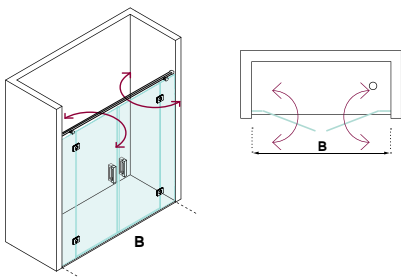



Rango de medida B	G0 Transparente		G1 Mate, Extraclaro, Gris, Bronce		G2 Espejo, Negro	
	BRILLO	BLACK LINE	BRILLO	BLACK LINE	BRILLO	BLACK LINE
Hasta 140	1100	1265	1243	1429	1320	1518
140 - 160	1128	1297	1274	1466	1353	1556
160 - 180	1169	1344	1321	1519	1402	1613
180 - 200	1210	1392	1368	1573	1453	1670
200 - 220	1242	1429	1404	1614	1491	1714

Características

-  2 fijos y 2 puertas con apertura 180 °
-  Espesor de vidrio 8 mm
-  Tratamiento antical a dos caras
-  Impresión digital, consultar pag:274
-  Altura 1950. Máxima hasta 2200mm
-  Cierre magnético
-  Ancho máximo de la puerta 900mm

Opciones

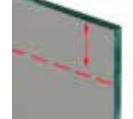
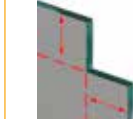
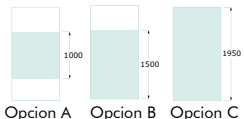
Cambio de tirador por pomo+60	En bañera, h=1500 al mismo precio	Incremento altura, +5% cada 5 cm	Recortes especiales en el vidrio, +90	Impresión digital personalizada, ver pag:274
				



NV4A

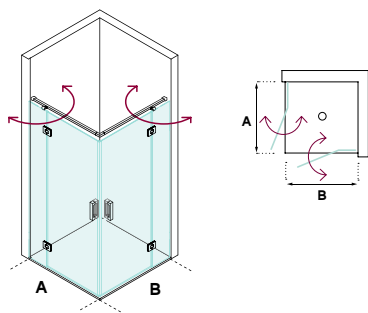

Rango de medida A + B	G0 Transparente		G1 Mate, Extraclaro, Gris, Bronce		G2 Espejo, Negro	
	B BRILLO	BLACK LINE	B BRILLO	BLACK LINE	B BRILLO	BLACK LINE
Hasta 140	1142	1313	1290	1484	1370	1576
140 - 160	1161	1335	1312	1509	1393	1602
160 - 180	1203	1383	1359	1563	1443	1660
180 - 200	1245	1432	1407	1618	1494	1718
200 - 220	1277	1469	1443	1660	1533	1762

Características

- 2 Fijos y 2 puertas con apertura a 180 °
- Espesor de vidrio 8 mm
- Tratamiento antical a dos caras
- Impresión digital, consultar pag:274
- Altura 1950. Máxima hasta 2200mm
- Cierre magnético
- Ancho máximo de la puerta 900mm

Opciones

Cambio de tirador por pomo+60	En bañera, h=1500 al mismo precio	Incremento altura, +5% cada 5 cm	Recortes especiales en el vidrio, +90	Impresión digital personalizada, ver pag:274

OPEN

OPEN



• Brazo largo de refuerzo en acero



• Perfil lateral en aluminio brillo



• Brazo corto para vidrios menores de 40cm



• Bisagras metálicas



• Barra superior junto a vidrio

• Tirador metálico

- B BRILLO
- B BRILLO
- B BRILLO
- B BRILLO
- BLACK LINE
- B BRILLO
- B BRILLO
- BLACK LINE
- B BRILLO
- B BRILLO
- M MATEADO
- B BRILLO
- M MATEADO
- B BRILLO
- M MATEADO
- BLACK LINE
- B BRILLO
- B BRILLO
- BLACK LINE
- B BRILLO
- B BRILLO
- BLACK LINE
- B BRILLO
- BLACK LINE
- B BRILLO
- BLACK LINE
- B BRILLO
- BLACK LINE
- B BRILLO
- M MATEADO
- M MATEADO
- BLACK LINE
- B BRILLO
- B BRILLO
- M MATEADO
- M MATEADO
- BLACK LINE
- M MATEADO
- BLACK LINE
- M MATEADO
- BLACK LINE
- B BRILLO
- M MATEADO
- BLACK LINE
- B BRILLO
- C COBRE
- BLACK LINE
- B BRILLO

- SOLID
- SIDE
- MOON
- STAR
- WALL
- SOLID
- SIDE
- MOON
- SUITE
- PASS
- DUNE
- FORUM
- NEXUS
- INFINITI
- ROLLING
- COMBI
- STAR
- HANDI
- FLEX
- NOVA
- OPEN
- QUADRO
- NATURE
- STYLE
- NEXUS
- TECHNICAL
- ROLLING
- INVISIBLE
- FRAME
- CASSONETTO
- CLICK
- PACK
- HIDRA
- DATOS TÉCNICOS
- DECORADOS

OPEN

OPEN

OPEN



OP2

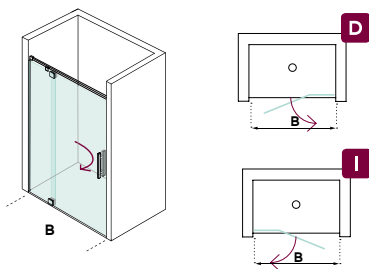

Rango de medida B	G0 Transparente	G1 Mate, Extraclaro, Gris, Bronce	G2 Espejo, Negro
		B BRILLO	B BRILLO
Hasta 100	611	690	733
100 - 120	634	717	761
120 - 140	653	737	783

Características

- 1 fijo y 1 puerta con apertura 180° exterior
- Espesor de vidrio 8 mm
- Tratamiento antical a dos caras
- Impresión digital, consultar pag:274
- Altura 1950. Máxima hasta 2400mm
- Cierre magnético
- Ancho máximo de la puerta 900mm

Opciones

Cambio de tirador por pomo+30	Incremento altura, +5% cada 5 cm	Recortes especiales en el vidrio, +90	Impresión digital personalizada, ver pag:274



OPEN

OP3

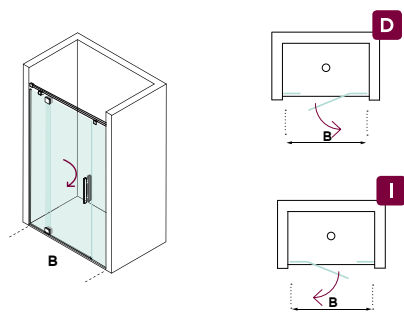

Rango de medida B	G0 Transparente	G1 Mate, Extraclaro, Gris, Bronce	G2 Espejo, Negro
	B BRILLO	B BRILLO	B BRILLO
Hasta 130	728	823	874
130 - 160	759	858	911
160 - 190	788	890	945
190 - 220	816	923	980

Características

- 2 fijos y 1 puerta con apertura 180° exterior
- Espesor de vidrio 8 mm
- Tratamiento antical a dos caras
- Impresión digital, consultar pag:274
- Altura 1950. Máxima hasta 2400mm
- Cierre magnético
- Ancho máximo de la puerta 900mm

Opciones

Cambio de tirador por pomo +30	Incremento altura, +5% cada 5 cm	Recortes especiales en el vidrio, +90	Impresión digital personalizada, ver pag:274
			<p>Opcion A Opcion B Opcion C</p>

OPEN



OPEN

OP3A

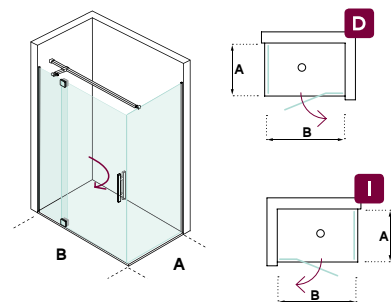

Características

-  2 fijos y 1 puerta con apertura 180° exterior
-  Espesor de vidrio 8 mm
-  Tratamiento antical a dos caras
-  Impresión digital, consultar pag:274
-  Altura 1950. Máxima hasta 2400mm
-  Cierre magnético
-  Ancho máximo de la puerta 900mm

Rango de medida A + B	G0 Transparente	G1 Mate, Extraclaro, Gris, Bronce	G2 Espejo, Negro
			
Hasta 130	837	946	1005
130 - 160	860	971	1032
160 - 190	879	993	1055
190 - 220	902	1019	1082

Opciones

Cambio de tirador por pomo+30	Incremento altura, +5% cada 5 cm	Recortes especiales en el vidrio, +90	Impresión digital personalizada, ver pag:274
			



OPEN

OP4

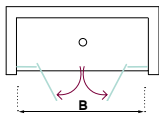
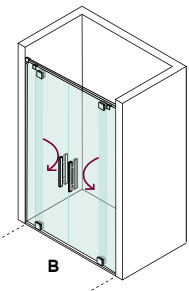

Rango de medida B	G0 Transparente	G1 Mate, Extraclaro, Gris, Bronce	G2 Espejo, Negro
	B BRILLO	B BRILLO	B BRILLO
Hasta 140	1098	1240	1317
140 - 160	1114	1258	1336
160 - 180	1142	1291	1371
180 - 200	1171	1323	1405

Características

- 2 fijos y 1 puerta con apertura 180° exterior
- Espesor de vidrio 8 mm
- Tratamiento antical a dos caras
- Impresión digital, consultar pag:274
- Altura 1950. Máxima hasta 2400mm
- Cierre magnético
- Ancho máximo de la puerta 900mm

Opciones

Cambio de tirador por pomo +60	Incremento altura, +5% cada 5 cm	Recortes especiales en el vidrio, +90	Impresión digital personalizada, ver pag:274
			<p>Opcion A Opcion B Opcion C</p>

QUADRO

QUADRO



• Brazo largo de refuerzo en acero



• Perfil lateral en aluminio brillo



• Bisagra entre vidrios



• Bisagras a pared



• Barra superior junto a vidrio



• Tirador metálico

- B** BRILLO
- B** BRILLO
- B** BRILLO
- B** BRILLO
- BLACK LINE** **B** BRILLO
- B** BRILLO
- B** BRILLO
- BLACK LINE** **B** BRILLO
- B** BRILLO
- B** BRILLO
- M** MATEADO **B** BRILLO
- M** MATEADO **B** BRILLO
- M** MATEADO **BLACK LINE** **B** BRILLO
- B** BRILLO
- B** BRILLO
- BLACK LINE** **B** BRILLO
- BLACK LINE** **B** BRILLO
- B** BRILLO
- B** BRILLO
- BLACK LINE** **B** BRILLO
- B** BRILLO
- BLACK LINE** **B** BRILLO
- BLACK LINE** **B** BRILLO
- M** MATEADO
- M** MATEADO **BLACK LINE**
- B** BRILLO
- B** BRILLO
- M** MATEADO
- M** MATEADO **BLACK LINE**
- M** MATEADO **BLACK LINE**
- M** MATEADO **BLACK LINE**
- M** MATEADO **BLACK LINE** **B** BRILLO
- C** COBRE **BLACK LINE** **B** BRILLO

- SOLID
- SIDE
- MOON
- STAR
- WALL
- SOLID
- SIDE
- MOON
- SUITE
- PASS
- DUNE
- FORUM
- NEXUS
- INFINITI
- ROLLING
- COMBI
- STAR
- HANDI
- FLEX
- NOVA
- OPEN
- QUADRO
- NATURE
- STYLE
- NEXUS
- TECHNICAL
- ROLLING
- INVISIBLE
- FRAME
- CASSONETTO
- CLICK
- PACK
- HIDRA
- DATOS TÉCNICOS
- DECORADOS

QUADRO

QUADRO



QUADRO

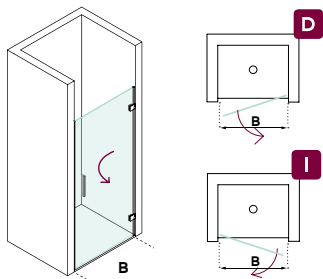

QDI









6 mm

8 mm





Características

-  1 puerta con apertura 90° exterior
-  Espesor de vidrio 6 mm
-  Espesor de vidrio 8 mm
-  Tratamiento antical a dos caras
-  Impresión digital, consultar pag:274
-  Altura 1950. Máxima hasta 2200mm
-  Cierre magnético con expansion de 10 mm
-  Ancho máximo de la puerta 800mm

Rango de medida B	G0 Transparente		G1 Mate, Extraclaro, Gris, Bronce		G2 Espejo, Negro	
	 BRILLO	 BLACK LINE	 BRILLO	 BLACK LINE	 BRILLO	 BLACK LINE
Hasta 60	458	527	518	596	550	633
60 - 80	478	549	540	621	573	659

Hasta 60	487	560	551	633	585	672
60 - 80	525	604	593	682	630	725

Opciones

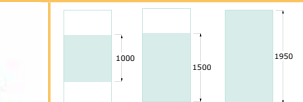
Cambio de tirador por pomo+30	En bañera, h=1500 al mismo precio	Incremento altura, +5% cada 5 cm	Recortes especiales en el vidrio, +90	Impresión digital personalizada, ver pag:274
				
				Opción A Opción B Opción C



QD2

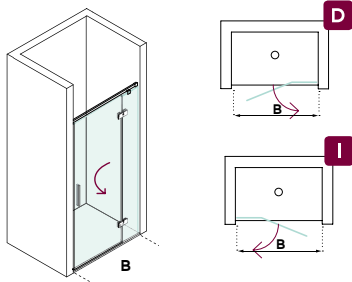

Características

- 1 Fijo y 1 puerta con apertura 90° exterior
- Espesor de vidrio 6 mm
- Espesor de vidrio 8 mm
- Tratamiento antical a dos caras
- Impresión digital, consultar pag:274
- Altura 1950. Máxima hasta 2200mm
- Cierre magnético con expansion de 10 mm
- Ancho máximo de la puerta 800mm

Rango de medida B	G0 Transparente		G1 Mate, Extraclaro, Gris, Bronce		G2 Espejo, Negro	
	BRILLO	BLAK LINE	BRILLO	BLAK LINE	BRILLO	BLAK LINE
Hasta 70	562	646	635	730	674	775
70 - 90	574	660	648	745	688	792
90 - 110	586	673	662	761	703	808
110 - 130	600	690	678	780	720	828

Hasta 70	613	704	692	796	735	845
70 - 90	628	722	709	815	753	866
90 - 110	645	742	729	838	774	890
110 - 130	668	768	754	867	801	921

Opciones

Cambio de tirador por pomo +30	En bañera, h=1500 al mismo precio	Incremento altura, +5% cada 5 cm	Recortes especiales en el vidrio, +90	Impresión digital personalizada, ver pag:274

QUADRO

QUADRO



QD2A

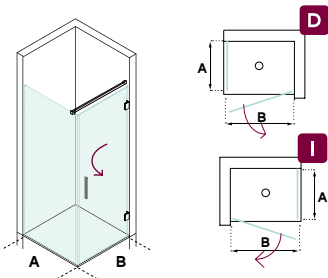

Rango de medida A + B	G0 Transparente		G1 Mate, Extraclaro, Gris, Bronce		G2 Espejo, Negro	
	B BRILLO	N BLACK LINE	B BRILLO	N BLACK LINE	B BRILLO	N BLACK LINE
Hasta 140	590	679	667	767	708	815
140 - 160	607	698	686	789	729	838

Hasta 140	658	756	743	854	789	907
140 - 160	680	782	768	884	816	938

Características

- 1 Fijo y 1 puerta con apertura 90° exterior
- Espesor de vidrio 6 mm
- Espesor de vidrio 8 mm
- Tratamiento antical a dos caras
- Impresión digital, consultar pag:274
- Altura 1950. Máxima hasta 2200mm
- Cierre magnético
- Ancho máximo de la puerta 800mm

Opciones				
Cambio de tirador por pomo+30	En bañera, h=1500 al mismo precio	Incremento altura, +5% cada 5 cm	Recortes especiales en el vidrio, +90	Impresión digital personalizada, ver pag:274
 				 Opción A Opción B Opción C



QD2AR

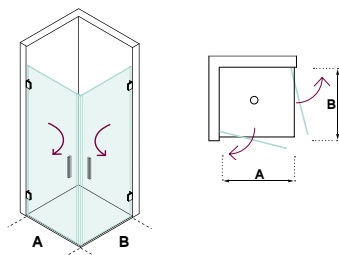

Rango de medida A + B	G0 Transparente		G1 Mate, Extraclaro, Gris, Bronce		G2 Espejo, Negro	
	B BRILLO	T BLACK LINE	B BRILLO	T BLACK LINE	B BRILLO	T BLACK LINE
Hasta 140	605	696	683	786	726	835
140 - 160	607	698	686	789	729	838



Hasta 140	658	756	743	854	789	907
140 - 160	660	759	746	858	792	911



Características

- 2 puertas con apertura 90° exterior
- Espesor de vidrio 6 mm
- Espesor de vidrio 8 mm
- Tratamiento antical a dos caras
- Impresión digital, consultar pag:274
- Altura 1950. Máxima hasta 2200mm
- Cierre magnético
- Ancho máximo de la puerta 800mm

Opciones

Cambio de tirador por pomo+60	En bañera, h=1500 al mismo precio	Incremento altura, +5% cada 5 cm	Recortes especiales en el vidrio, +90	Impresión digital personalizada, ver pag:274

QUADRO

QUADRO



QD2R

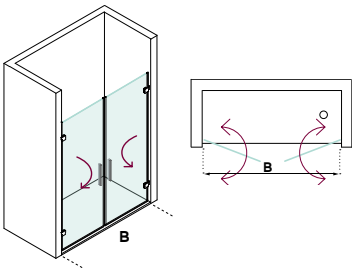

Características



-  2 puertas con apertura 90° exterior
-  Espesor de vidrio 6 mm
-  Espesor de vidrio 8 mm
-  Tratamiento antical a dos caras
-  Impresión digital, consultar pag:274
-  Altura 1950. Máxima hasta 2200mm
-  Cierre magnético
-  Ancho máximo de la puerta 800mm



Rango de medida B	G0 Transparente		G1 Mate, Extraclaro, Gris, Bronce		G2 Espejo, Negro	
	 BRILLO	 BLACK LINE	 BRILLO	 BLACK LINE	 BRILLO	 BLACK LINE
Hasta 100	631	726	713	820	757	871
100 - 120	641	737	724	833	769	884
120 - 140	655	753	740	851	786	904
140 - 160	672	773	759	873	806	927

Hasta 100	693	796	783	900	831	956
100 - 120	705	811	797	916	846	973
120 - 140	728	837	822	945	873	1004
140 - 160	750	863	848	975	900	1035

Opciones

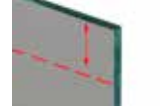
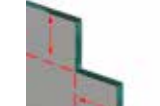
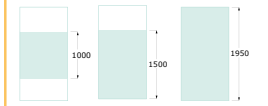
Cambio de tirador por pomo+30	En bañera, h=1500 al mismo precio	Incremento altura, +5% cada 5 cm	Recortes especiales en el vidrio, +90	Impresión digital personalizada, ver pag:274
				
				Opción A Opción B Opción C



QD2F

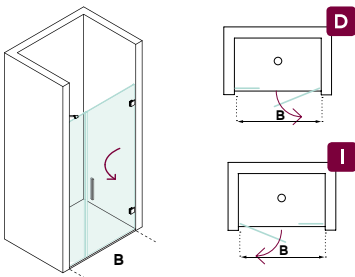

Características

- 1 Fijo y 1 puerta con apertura 90° exterior
- Espesor de vidrio 6 mm
- Espesor de vidrio 8 mm
- Tratamiento antical a dos caras
- Impresión digital, consultar pag:274
- Altura 1950. Máxima hasta 2200mm
- Cierre magnético
- Ancho máximo de la puerta 800mm

Rango de medida B	G0 Transparente		G1 Mate, Extraclaro, Gris, Bronce		G2 Espejo, Negro	
	BRILLO	BLACK LINE	BRILLO	BLACK LINE	BRILLO	BLACK LINE
Hasta 80	605	696	683	786	726	835
80 - 100	624	718	705	811	749	861
100 - 120	634	729	716	823	760	874
120 - 140	646	742	730	839	775	891
140 - 160	660	759	746	858	792	911

Hasta 80	660	759	746	858	792	911
80 - 100	680	782	768	884	816	938
100 - 120	710	817	802	923	852	980
120 - 140	715	822	808	929	858	987
140 - 160	738	848	833	958	885	1018

Opciones

Cambio de tirador por pomo+30	En bañera, h=1500 al mismo precio	Incremento altura, +5% cada 5 cm	Recortes especiales en el vidrio, +90	Impresión digital personalizada, ver pag:274

QUADRO







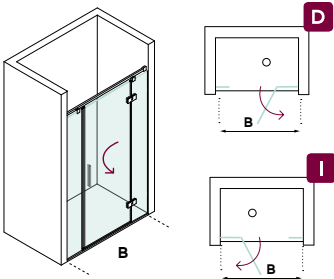



QUADRO









QD3





Características

-  2 Fijos y 1 puerta con apertura 90° exterior 
-  Espesor de vidrio 6 mm 
-  Espesor de vidrio 8 mm 
-  Tratamiento antical a dos caras
-  Impresión digital, consultar pag:274
-  Altura 1950. Máxima hasta 2200mm
-  Cierre magnético
-  Ancho máximo de la puerta 800mm

Rango de medida B	G0 Transparente		G1 Mate, Extraclaro, Gris, Bronce		G2 Espejo, Negro	
	 BRILLO	 BLACK LINE	 BRILLO	 BLACK LINE	 BRILLO	 BLACK LINE
Hasta 120	686	789	776	892	824	947
120 - 140	698	803	789	908	838	964
140 - 160	710	817	803	923	852	980
160 - 180	720	828	814	936	864	994
180 - 200	737	847	833	957	884	1017

Hasta 120	755	868	853	981	906	1042
120 - 140	770	886	870	1001	924	1063
140 - 160	788	906	890	1023	945	1087
160 - 180	805	926	910	1046	966	1111
180 - 200	828	952	935	1075	993	1142

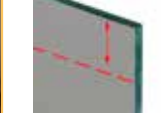
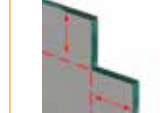
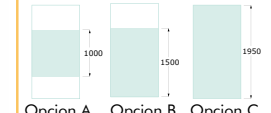





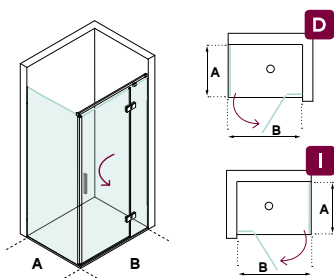

Opciones				
Cambio de tirador por pomo+30	En bañera, h=1500 al mismo precio	Incremento altura, +5% cada 5 cm	Recortes especiales en el vidrio, +90	Impresión digital personalizada, ver pag:274
				
				Opción A Opción B Opción C







QD3A





Características

-  2 Fijos y 1 puerta con apertura 90° exterior 
-  Espesor de vidrio 6 mm
-  Espesor de vidrio 8 mm
-  Tratamiento antical a dos caras
-  Impresión digital, consultar pag:274
-  Altura 1950. Máxima hasta 2200mm
-  Cierre magnético
-  Ancho máximo de la puerta 800mm

Rango de medida A + B	G0 Transparente		G1 Mate, Extraclaro, Gris, Bronce		G2 Espejo, Negro	
	 BRILLO	 BLACK LINE	 BRILLO	 BLACK LINE	 BRILLO	 BLACK LINE
Hasta 140	698	803	789	908	838	964
140 - 160	710	817	803	923	852	980
160 - 180	720	828	814	936	864	994
180 - 200	737	847	833	957	884	1017
200 - 220	754	867	852	979	904	1040

Hasta 140	770	886	870	1001	924	1063
140 - 160	788	906	890	1023	945	1087
160 - 180	805	926	910	1046	966	1111
180 - 200	828	952	935	1075	993	1142
200 - 220	850	978	961	1105	1020	1173

Opciones

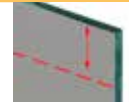
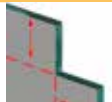
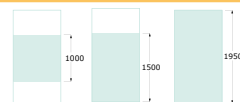
Cambio de tirador por pomo +30	En bañera, h=1500 al mismo precio	Incremento altura, +5% cada 5 cm	Recortes especiales en el vidrio, +90	Impresión digital personalizada, ver pag:274
				 Opcion A Opcion B Opcion C

QUADRO







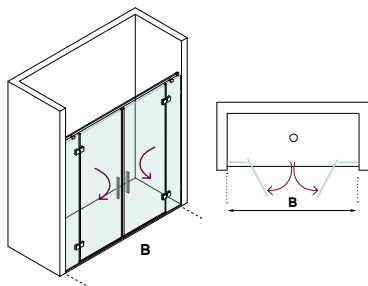



QUADRO



QD4





Características

-  2 Fijos y 2 puertas con apertura 90° exterior 
-  Espesor de vidrio 6 mm 
-  Espesor de vidrio 8 mm 
-  Tratamiento antical a dos caras
-  Impresión digital, consultar pag:274
-  Altura 1950. Máxima hasta 2200mm
-  Cierre magnético
-  Ancho máximo de la puerta 800mm

Rango de medida B	G0 Transparente		G1 Mate, Extraclaro, Gris, Bronce		G2 Espejo, Negro	
	 BRILLO	 BLACK LINE	 BRILLO	 BLACK LINE	 BRILLO	 BLACK LINE
Hasta 140	874	1005	987	1135	1048	1206
140 - 160	881	1013	995	1145	1057	1216
160 - 180	898	1032	1014	1166	1077	1239
180 - 200	912	1049	1031	1185	1094	1259
200 - 220	922	1060	1041	1198	1106	1272

Hasta 140	963	1107	1088	1251	1155	1328
140 - 160	973	1118	1099	1264	1167	1342
160 - 180	995	1144	1124	1293	1194	1373
180 - 200	1018	1170	1150	1322	1221	1404
200 - 220	1030	1185	1164	1338	1236	1421

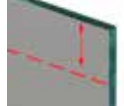
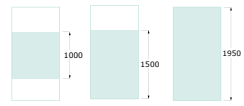





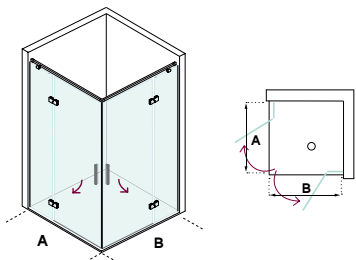

Opciones				
Cambio de tirador por pomo+60	En bañera, h=1500 al mismo precio	Incremento altura, +5% cada 5 cm	Recortes especiales en el vidrio, +90	Impresión digital personalizada, ver pag:274
				 Opción A Opción B Opción C







QD4A



Características

-  2 Fijos y 2 puertas con apertura 90° exterior 
-  Espesor de vidrio 6 mm
-  Espesor de vidrio 8 mm
-  Tratamiento antical a dos caras
-  Impresión digital, consultar pag:274
-  Altura 1950. Máxima hasta 2200mm
-  Cierre magnético
-  Ancho máximo de la puerta 800mm

Rango de medida A + B	G0 Transparente		G1 Mate, Extraclaro, Gris, Bronce		G2 Espejo, Negro	
	 BRILLO	 BLACK LINE	 BRILLO	 BLACK LINE	 BRILLO	 BLACK LINE
Hasta 140	883	1016	998	1148	1060	1219
140 - 160	890	1024	1006	1157	1068	1229
160 - 180	907	1043	1025	1179	1089	1252
180 - 200	922	1060	1041	1198	1106	1272
200 - 220	931	1071	1052	1210	1117	1285

Hasta 140	973	1118	1099	1264	1167	1342
140 - 160	983	1130	1110	1277	1179	1356
160 - 180	1005	1156	1136	1306	1206	1387
180 - 200	1028	1182	1161	1335	1233	1418
200 - 220	1040	1196	1175	1351	1248	1435
220 - 240	1068	1228	1206	1387	1281	1473
240 - 260	1095	1259	1237	1423	1314	1511
260 - 280	1123	1291	1268	1459	1347	1549
280 - 300	1150	1323	1300	1494	1380	1587

Opciones

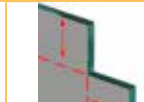
Cambio de tirador por pomo +60	En bañera, h=1500 al mismo precio	Incremento altura, +5% cada 5 cm	Recortes especiales en el vidrio, +90	Impresión digital personalizada, ver pag:274
				 Opcion A Opcion B Opcion C

NATURE

NATURE



• Brazo largo de refuerzo en acero



• Soporte de brazo a pared



• Soporte de suelo a techo



• Perfil aluminio alto brillo



• Junta de 90° de policarbonato

	B BRILLO	SOLID
	B BRILLO	SIDE
	B BRILLO	MOON
	B BRILLO	STAR
	BLACK LINE	WALL
	B BRILLO	SOLID
	B BRILLO	SIDE
	BLACK LINE	MOON
	B BRILLO	SUITE
	B BRILLO	PASS
M MATEADO	B BRILLO	DUNE
M MATEADO	B BRILLO	FORUM
M MATEADO	BLACK LINE	NEXUS
	B BRILLO	INFINITI
	B BRILLO	ROLLING
	BLACK LINE	COMBI
	BLACK LINE	STAR
	B BRILLO	HANDI
	B BRILLO	FLEX
	BLACK LINE	NOVA
	B BRILLO	OPEN
	BLACK LINE	QUADRO
	BLACK LINE	NATURE
M MATEADO		STYLE
M MATEADO	BLACK LINE	NEXUS
	B BRILLO	TECHNICAL
	B BRILLO	ROLLING
M MATEADO		INVISIBLE
M MATEADO	BLACK LINE	FRAME
M MATEADO	BLACK LINE	CASSONETTO
M MATEADO	BLACK LINE	CLICK
M MATEADO	BLACK LINE	PACK
M MATEADO	BLACK LINE	HIDRA
C COBRE	BLACK LINE	DATOS TÉCNICOS
	B BRILLO	DECORADOS

NATURE

NATURE





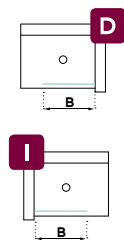
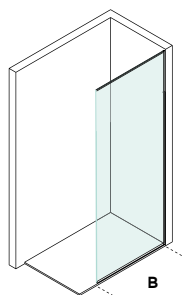

NT00



Rango de medida B	G0 Transparente		G1 Mate, Extraclaro, Gris, Bronce		G2 Espejo, Negro	
	B BRILLO	N BLACK LINE	B BRILLO	N BLACK LINE	B BRILLO	N BLACK LINE
Hasta 900	562	618	635	698	674	741
900 - 110	616	677	696	765	739	813
110 - 130	720	792	814	895	864	950
130 - 150	857	942	968	1.065	1028	1131

Características

-  1 Fijo de suelo a techo
-  Espesor de vidrio 8 mm
-  Tratamiento antical a dos caras
-  Impresión digital, consultar pag:274
-  Altura 2300. Máxima hasta 2500mm

Opciones

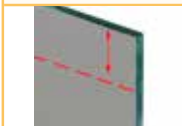
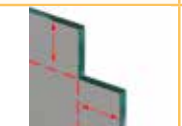
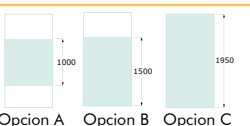
Incremento altura, +5% cada 5 cm	Recortes especiales en el vidrio, +90	Impresión digital personalizada, ver pag:274
		 <p>Opción A Opción B Opción C</p>



NATURE

NT01

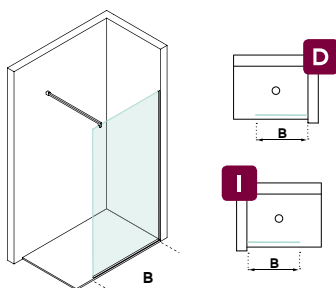

Rango de medida B	G0 Transparente		G1 Mate, Extraclaro, Gris, Bronce		G2 Espejo, Negro	
	B BRILLO	BLACK LINE	B BRILLO	BLACK LINE	B BRILLO	BLACK LINE
Hasta 900	354	390	400	440	425	468
900 - 110	372	409	420	462	446	491

Hasta - 900	381	419	430	473	457	502
900 - 110	400	440	452	498	480	529
110 - 130	573	630	647	712	687	756
130 - 150	614	675	693	763	736	810

Características

- 1 Fijo con brazo de refuerzo
- Espesor de vidrio 6 mm
- Espesor de vidrio 8 mm
- Tratamiento antical a dos caras
- Impresión digital, consultar pag:274
- Altura 1950.
Máxima hasta 2200mm en vidrio de 6
Máxima hasta 2500mm en vidrio de 8

Opciones			
En bañera, h=1500 al mismo precio	Incremento altura, +5% cada 5 cm	Recortes especiales en el vidrio, +90	Impresión digital personalizada, ver pag:274

NATURE

NATURE





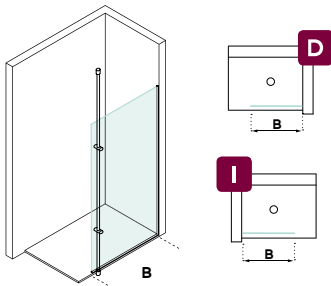

NT02



Rango de medida B	G0 Transparente	G1 Mate, Extraclaro, Gris, Bronce	G2 Espejo, Negro
		B BRILLO	B BRILLO
Hasta 900	506	572	607
900 - 110	528	596	633
110 - 130	787	890	945
130 - 150	807	912	969

Características

-  1 Fijo con barra de refuerzo vertical
-  Espesor de vidrio 8 mm
-  Tratamiento antical a dos caras
-  Impresión digital, consultar pag:274
-  Altura 1950. Máxima hasta 2500mm

Opciones			
En bañera, h=1500 al mismo precio	Incremento altura, +5% cada 5 cm	Recortes especiales en el vidrio, +90	Impresión digital personalizada, ver pag:274
			
			Opción A Opción B Opción C



NATURE

NT04

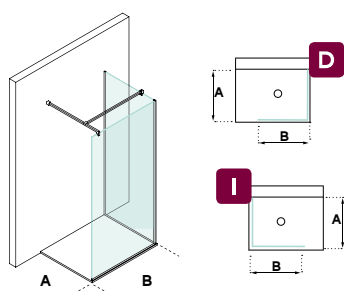

Rango de medida A + B	G0 Transparente		G1 Mate, Extraclaro, Gris, Bronce		G2 Espejo, Negro	
	B BRILLO	BL BLACK LINE	B BRILLO	BL BLACK LINE	B BRILLO	BL BLACK LINE
Hasta 160	560	616	633	696	672	739
160 - 200	643	707	726	799	771	849
200 - 240	731	804	826	909	877	965

Características

- 2 Fijos con barra de refuerzo
- 6 mm Espesor de vidrio 8 mm
- X2 Tratamiento antical a dos caras
- Impresión digital Impresión digital, consultar pag:274
- 1950mm Altura 1950. Máxima hasta 2500mm

Opciones			
En bañera, h=1500 al mismo precio	Incremento altura, +5% cada 5 cm	Recortes especiales en el vidrio, +90	Impresión digital personalizada, ver pag:274

NATURE

NATURE





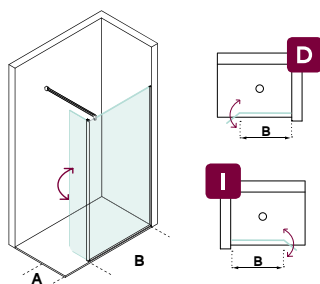



NT06



Rango de medida A + B	G0 Transparente		G1 Mate, Extraclaro, Gris, Bronce		G2 Espejo, Negro	
	B BRILLO	N BLACK LINE	B BRILLO	N BLACK LINE	B BRILLO	N BLACK LINE
Hasta 100	487	560	551	633	585	672
100 - 120	504	580	570	655	605	696
120 - 140	561	645	634	729	673	774

Características

-  1 Fijo con un Ala batiente a 180°
-  Espesor de vidrio 6 mm
-  Tratamiento antical a dos caras
-  Impresión digital, consultar pag:274
-  Altura 1950. Máxima hasta 2200mm
-  Ancho máximo del Ala batiente 350mm

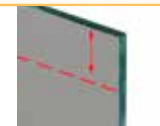
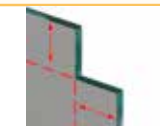
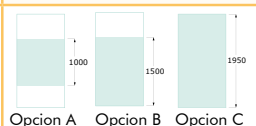
Opciones			
En bañera, h=1500 al mismo precio	Incremento altura, +5% cada 5 cm	Recortes especiales en el vidrio, +90	Impresión digital personalizada, ver pag:274
			



BARRA LUX

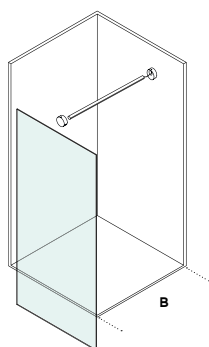

Características

Barra con luz en aluminio anodizado mate.
 Soporte a pared regulable con prisioneros de ajuste y embellecedor para ocultar el cable.
 Soporte a vidrio regulable con prisioneros de regulación para mamparas de 6 mm y 8 mm.
 Tubo refuerzo Lux con Luminaria de 15W/m, con sellado Epoxi para total estanqueidad frente al agua, según normativa IP66.
 Soporte válido para cualquier modelo de mampara.
 Producto fabricado a medida en aluminio anodizado mate.

Rango de medida de la barra	M MATE
Hasta - 90	205
90 - 120	240

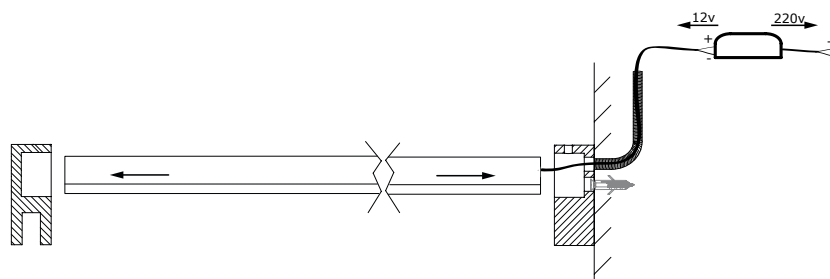

TOMA DE MEDIDAS

Indicar la anchura del plato o distancia entre vidrio y pared.
 Para colocación en obra nueva, dejar una salida de tubo corrugado a 1980 mm de altura.
 Para colocación en obra ya ejecutada, subir el cableado hasta el techo con canaleta adhesiva.



Barra soporte con luz



Pinza fijación a vidrio



Fijación a pared

PUERTAS DE PASO.....

Correderas

Style

Pag:226

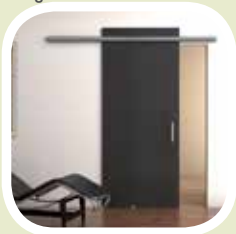

Nexus

Pag:228



Technical

Pag:234



Rolling

Pag:236



Invisible

Pag:238



Batientes

Click

Pag:246



Pack

Pag:248



Hidra

Pag:250



Ocultas

Cassonetto

Pag:252



Frame

Pag:242



		B BRILLO	SOLID
		B BRILLO	SIDE
		B BRILLO	MOON
		B BRILLO	STAR
	BLACK LINE	B BRILLO	WALL
		B BRILLO	SOLID
		B BRILLO	SIDE
	BLACK LINE	B BRILLO	MOON
		B BRILLO	SUITE
		B BRILLO	PASS
M MATEADO		B BRILLO	DUNE
M MATEADO		B BRILLO	FORUM
M MATEADO	BLACK LINE	B BRILLO	NEXUS
		B BRILLO	INFINITI
		B BRILLO	ROLLING
	BLACK LINE	B BRILLO	COMBI
	BLACK LINE	B BRILLO	STAR
		B BRILLO	HANDI
		B BRILLO	FLEX
	BLACK LINE	B BRILLO	NOVA
		B BRILLO	OPEN
	BLACK LINE	B BRILLO	QUADRO
	BLACK LINE	B BRILLO	NATURE
M MATEADO			STYLE
M MATEADO	BLACK LINE		NEXUS
		B BRILLO	TECHNICAL
		B BRILLO	ROLLING
M MATEADO			INVISIBLE
M MATEADO	BLACK LINE		FRAME
M MATEADO			CASSONETTO
M MATEADO	BLACK LINE		CLICK
M MATEADO	BLACK LINE	B BRILLO	PACK
C COBRE	BLACK LINE	B BRILLO	HIDRA
			DATOS TÉCNICOS
			DECORADOS





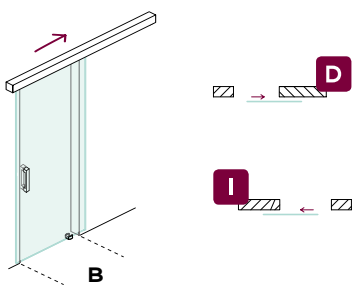

STYLE



SYI



Características

-  1 puerta corredera
-  Espesor vidrio 8 mm
-  Altura 2200.
-  Ruedas con ajuste vertical
-  Ancho máximo de la puerta 1000 mm
-  Peso máximo soportado 75kg
-  En vidrio de 10mm, PVP+15%

Rango de medida B	G0 Transparente	G1 Mate, Extraclaro, Gris,	G2 Espejo, Negro
Hasta 80	543	614	652
80 - 100	569	643	683

• COLOCACIÓN GUÍA A PARED

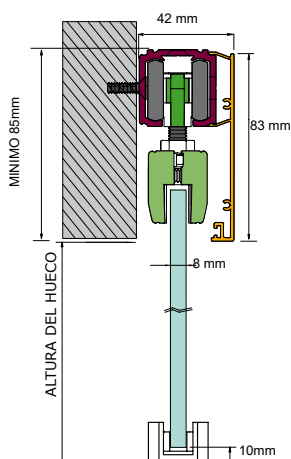

• PINZAS DE FIJACIÓN

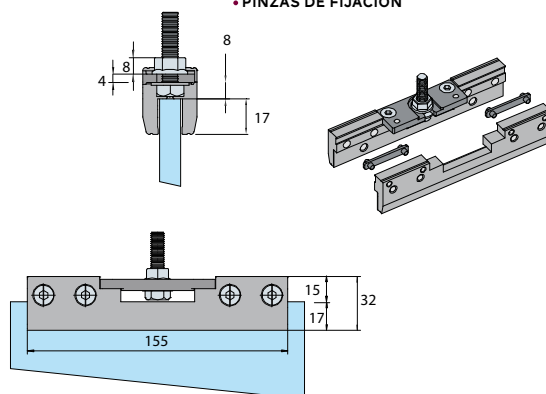

Opciones

Cambio de tirador por uñero +30



Impresión digital personalizada, ver pag: 274

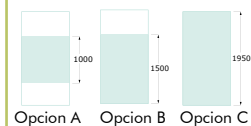





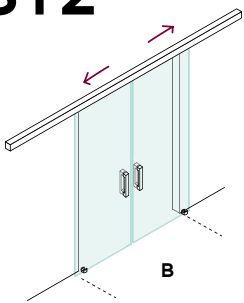





SY2



Características

-  2 puertas correderas
-  Espesor vidrio 8 mm
-  Altura 2200.
-  Ruedas con ajuste vertical
-  Ancho máximo de la puerta 1000 mm
-  Peso máximo soportado 75kg
-  En vidrio de 10mm, PVP+15%

Rango de medida B	G0 Transparente	G1 Mate, Extraclaro, Gris,	G2 Espejo, Negro
			
Hasta 140	878	992	1053
140 - 160	925	1045	1110



• TIRADOR METÁLICO



• RODAMIENTOS AJUSTABLES



• PINZAS PRISONERAS

Opciones

Cambio de tirador por uñero +60



Impresión digital personalizada, ver pag:274

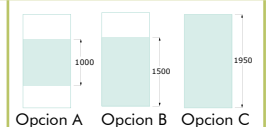







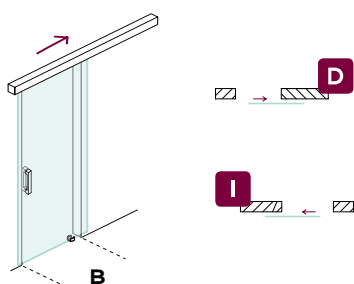



NEXUS



PXI



Características

-  Puerta corredera en 8mm
-  Espesor vidrio 8 mm
-  Altura 2200. Máxima hasta 2500mm
-  Ruedas con ajuste vertical
-  Cierre amortiguado incluido
-  Ancho máximo de la puerta 1200 mm
-  Peso máximo soportado 120kg
-  Impresión digital, consultar pag:274
-  En vidrio de 10mm, PVP+15%
-  Incremento de altura, cada 5cm +5%

Rango de medida B	G0 Transparente		G1 Mate, Extraclaro, Gris, Bronce		G2 Espejo, Negro	
	M MATE	BLACK LINE	M MATE	BLACK LINE	M MATE	BLACK LINE
Hasta 80	706	811	797	917	847	974
80 - 100	740	852	837	962	889	1022
100 - 120	835	960	944	1085	1002	1152

• COLOCACIÓN GUÍA A PARED

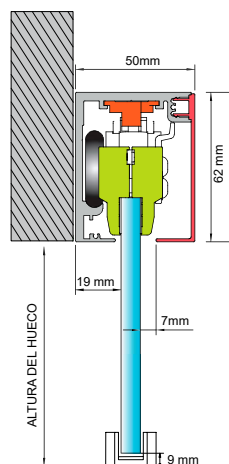

• COLOCACIÓN GUÍA A TECHO

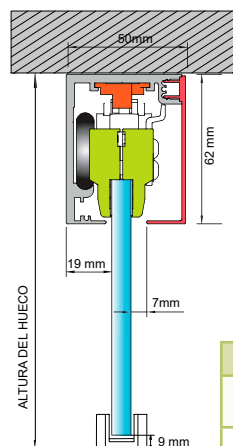

• PINZAS DE FIJACIÓN CON FRENO

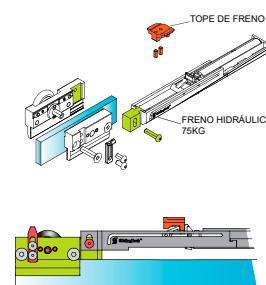

Opciones

Cambio de tirador por número+30



Impresión digital personalizada, ver pag:274

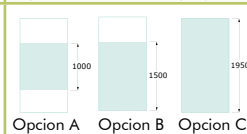



PX2R

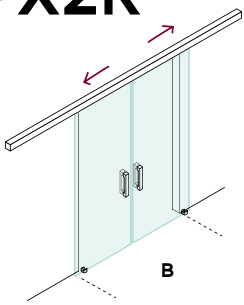

Rango de medida B	G0 Transparente		G1 Mate, Extraclaro, Gris, Bronce		G2 Espejo, Negro	
	M MATE	BLACK LINE	M MATE	BLACK LINE	M MATE	BLACK LINE
Hasta 160	1229	1413	1389	1597	1475	1696
160 - 200	1365	1570	1542	1774	1638	1884
200- 240	1593	1832	1800	2070	1912	2198

• COLOCACIÓN GUÍA A PARED

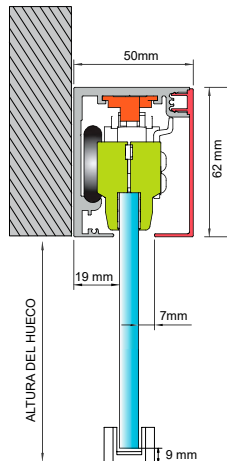

• COLOCACIÓN GUÍA A TECHO

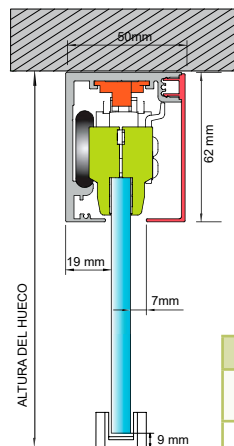

• PINZAS DE FIJACIÓN CON FRENO

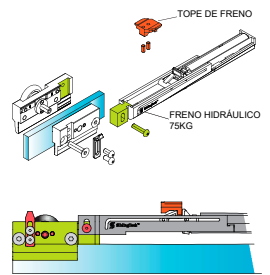

Características

- 2 Puertas correderas en 8mm
- Espesor vidrio 8 mm
- Altura 2200. Máxima hasta 2500mm
- Ruedas con ajuste vertical
- Cierre amortiguado incluido
- Ancho máximo de la puerta 1200 mm
- Peso máximo soportado 120kg
- Impresión digital, consultar pag:274
- En vidrio de 10mm, PVP+15%
- Incremento de altura, cada 5cm +5%

Opciones

Cambio de tirador por uñero+60



Impresión digital personalizada, ver pag:274

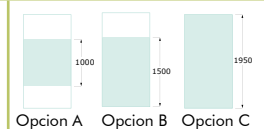



NEXUS



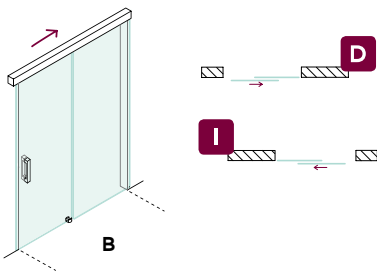





PX2M



Características

-  1 Fijo y 1 Puerta corredera en 8mm
-  Espesor vidrio 8 mm
-  Altura 2200. Máxima hasta 2500mm
-  Ruedas con ajuste vertical
-  Cierre amortiguado incluido
-  Ancho máximo de la puerta 1200 mm
-  Peso máximo soportado 120kg
-  Impresión digital, consultar pag:274
-  En vidrio de 10mm, PVP+15%
-  Incremento de altura, cada 5cm +5%

Rango de medida B	G0 Transparente		G1 Mate, Extraclaro, Gris, Bronce		G2 Espejo, Negro	
	 M MATE	 BLACK LINE	 M MATE	 BLACK LINE	 M MATE	 BLACK LINE
Hasta 140	892	1026	1008	1159	1070	1231
140 - 160	939	1080	1061	1220	1127	1296
160 - 180	971	1117	1097	1262	1165	1340
180 - 200	994	1143	1123	1291	1193	1371
200 - 220	1105	1271	1249	1436	1326	1525
220 - 240	1133	1302	1280	1472	1359	1563

• COLOCACIÓN GUÍA A PARED

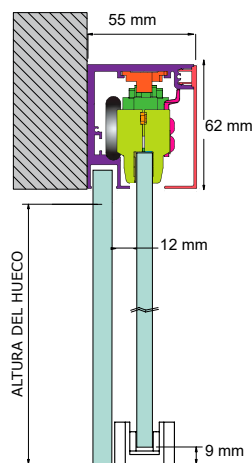

• COLOCACIÓN GUÍA A TECHO

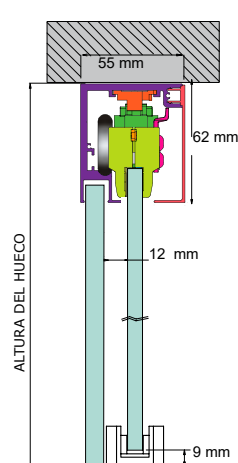

Opciones

Cambio de tirador por  uñero +30



Impresión digital personalizada, ver pag:274

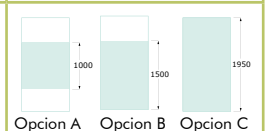



PX3

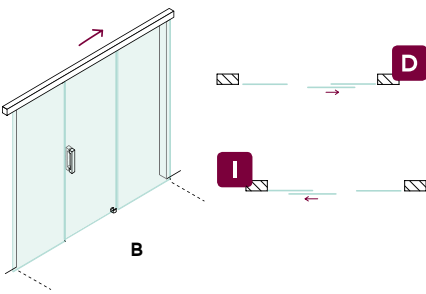

Rango de medida B	G0 Transparente		G1 Mate, Extraclaro, Gris, Bronce		G2 Espejo, Negro	
	M MATE	BLACK LINE	M MATE	BLACK LINE	M MATE	BLACK LINE
Hasta 210	1100	1265	1243	1429	1320	1518
210 - 240	1156	1329	1306	1502	1387	1595
240 - 270	1241	1427	1402	1612	1489	1712
270 - 300	1265	1454	1429	1643	1517	1745

Características

- 2 Fijos y 1 Puerta corredera en 8mm
- Espesor vidrio 8 mm
- Altura 2200. Máxima hasta 2500mm
- Ruedas con ajuste vertical
- Cierre amortiguado incluido
- Ancho máximo de la puerta 1200 mm
- Peso máximo soportado 120kg
- Impresión digital, consultar pag:274
- En vidrio de 10mm, PVP+15%
- Incremento de altura, cada 5cm +5%

• PINZAS DE FIJACIÓN CON FRENO

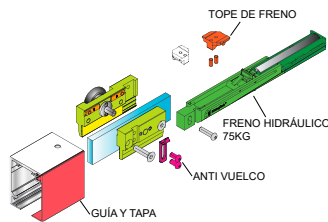

*TIRADOR METÁLICO MATE 30 CM



*UÑERO METÁLICO MATE



*PINZA DE AGARRE A VIDRIO

Opciones

Cambio de tirador por uñero +60



Impresión digital personalizada, ver pag:274

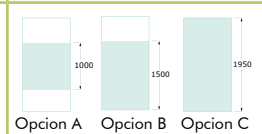







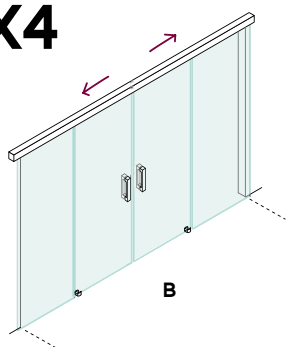

NEXUS



PX4



Características

-  2 Fijos y 2 Puertas correderas en 8mm
-  Espesor vidrio 8 mm
-  Altura 2200. Máxima hasta 2500mm
-  Ruedas con ajuste vertical
-  Cierre amortiguado incluido
-  Ancho máximo de la puerta 1200 mm
-  Peso máximo soportado 120kg
-  Impresión digital, consultar pag:274
-  En vidrio de 10mm, PVP+15%
-  Incremento de altura, cada 5cm +5%

Rango de medida B	G0 Transparente		G1 Mate, Extraclaro, Gris, Bronce		G2 Espejo, Negro	
	 M MATE	 BLACK LINE	 M MATE	 BLACK LINE	 M MATE	 BLACK LINE
Hasta 280	1663	1912	1829	2103	2012	2313
280 - 320	1859	2138	2045	2352	2249	2587
320 - 360	1985	2282	2183	2510	2401	2761
360 - 400	2092	2405	2301	2646	2531	2910

• COLOCACIÓN GUÍA A PARED

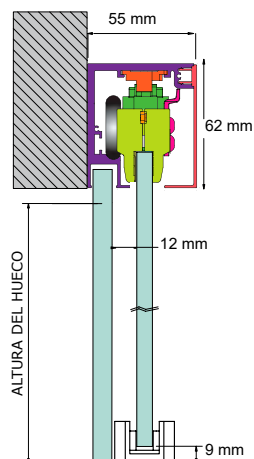

• COLOCACIÓN GUÍA A TECHO

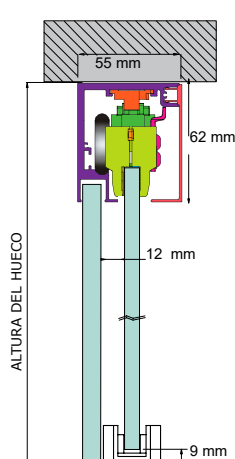

Opciones

Cambio de tirador por  uñero +60



Impresión digital personalizada, ver pag:274

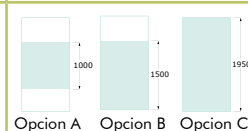

• KIT SINCRÓ PARA PUERTAS DOBLES NEXUS

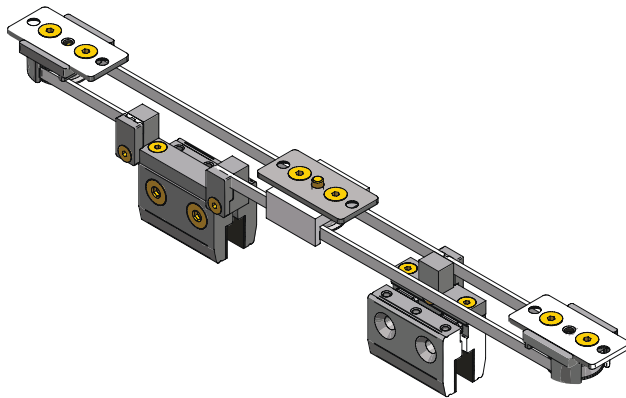

El kit sincronizado permite con solo desplazar una de las puertas , abrir la conntigua de manera simultanea
 Precio del kit: 360 € pvp

• MODELOS QUE ACEPTAN EL KIT SINCRÓ

PX2R

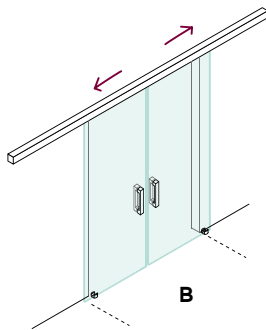

PX4

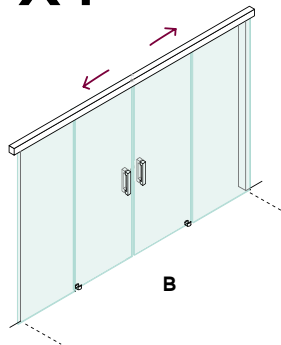

• DIFERENTES TIPOS DE PINZAS SEGÚN EL PESO DE LA PUERTA

				Distancia de frenado	Kit de pinzas según peso
	65 kg	600 mm	385 mm	60 mm	
	90 kg	790 mm	530 mm	75 mm	
	120 kg	905 mm	625 mm	85 mm	

TECHNICAL



TCI

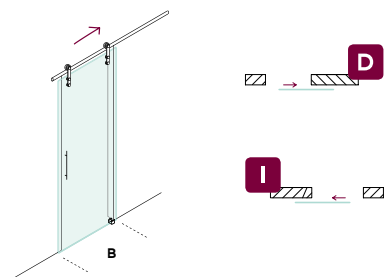

Características

-  1 puerta corredera
-  Espesor vidrio 10 mm
-  Altura 2200. Máxima hasta 2500mm
-  Ruedas con ajuste vertical
-  Ancho máximo de la puerta 1200 mm
-  Peso máximo soportado 70kg
-  Impresión digital, consultar pag:274
-  Incremento de altura, cada 5cm +5%

Rango de medida B	G0 Transparente	G1 Mate, Extraclaro, Gris, Bronce
		
Hasta 90	775	876
90 - 120	845	955

• COLOCACIÓN GUÍA A PARED

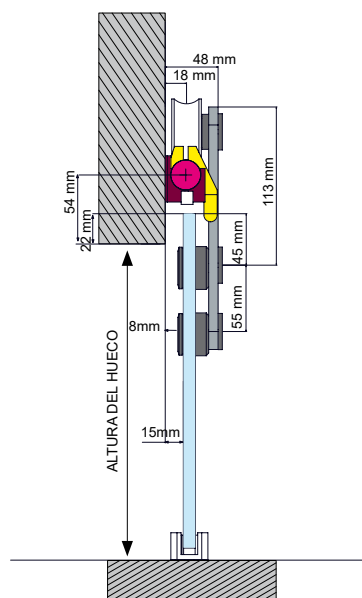

• RUEDAS CON REGULACIÓN

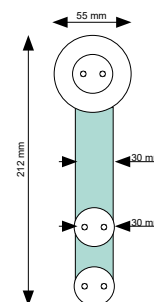

Opciones

Cambio de tirador por número+30



Impresión digital personalizada, ver pag:274

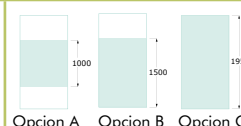



TC2R

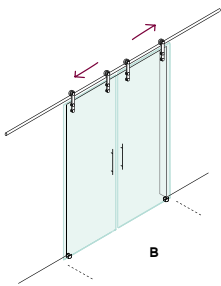

Rango de medida B	G0 Transparente	G1 Mate, Extraclaro, Gris, Bronce
Hasta 180	1.379	1.558
180 - 240	1.491	1.685

Características

- 2 puertas correderas
- Espesor vidrio 10 mm
- Altura 2200. Máxima hasta 2500mm
- Ruedas con ajuste vertical
- Ancho máximo de la puerta 1200 mm
- Peso máximo soportado 70kg
- Impresión digital, consultar pag:274
- Incremento de altura, cada 5cm +5%



• TIRADOR METÁLICO



• UÑERO ACERO ANODIZADO



• RODAMIENTO ACERO ANODIZADO

Opciones

Cambio de tirador por uñero +60



Impresión digital personalizada, ver pag:274

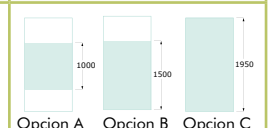

ROLLING



PLI

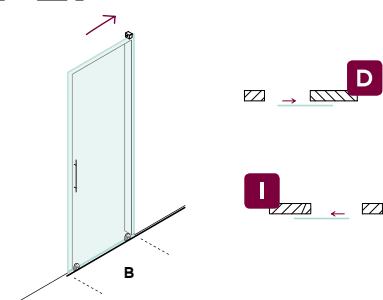

Características

-  1 puerta corredera
-  Espesor vidrio 8 mm
-  Altura 2200.
-  Ruedas con ajuste vertical
-  Ancho máximo de la puerta 1200 mm
-  Peso máximo soportado 100kg
-  Impresión digital, consultar pag:274
-  Incremento de altura, cada 5cm +5%

Rango de medida B	G0 Transparente	G1 Mate, Extraclaro, Gris,	G2 Espejo, Negro
			
Hasta 90	764	864	917
90 - 120	842	952	1011

• INSTALACIÓN A PARED

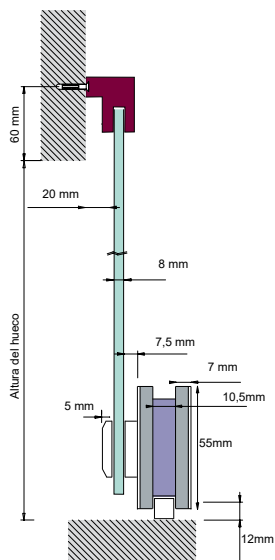

• DETALLE DEL RODAMIENTO

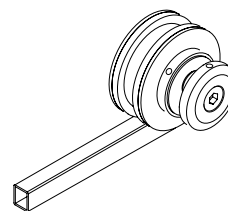

Opciones

Cambio de tirador por uñero +30



Impresión digital personalizada, ver pag:274

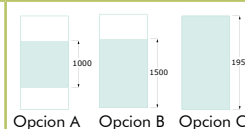





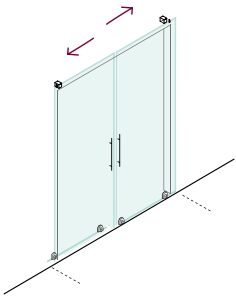

PL2R



Características

-  2 puertas correderas
-  Espesor vidrio 8 mm
-  Altura 2200.
-  Ruedas con ajuste vertical
-  Ancho máximo de la puerta 1200 mm
-  Peso máximo soportado 100kg
-  Impresión digital, consultar pag:274
-  Incremento de altura, cada 5cm +5%

Rango de medida B	G0 Transparente	G1 Mate, Extraclaro, Gris,	G2 Espejo, Negro
			
Hasta 180	1245	1407	1494
180 - 240	1469	1660	1763



• TIRADOR METALICO



• UÑERO METALICO



• RODAMIENTO ACERO INOX

Opciones

Cambio de tirador por uñero +60



Impresión digital personalizada, ver pag:274

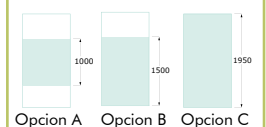



INVISIBLE

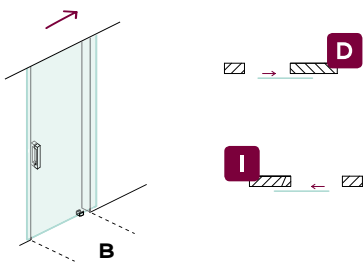

IVI



Características

-  1 puerta corredera
-  Espesor vidrio 10 mm
-  Altura 2400.
-  Ruedas con ajuste vertical
-  Ancho máximo de la puerta 1200 mm
-  Peso máximo soportado 150kg
-  Impresión digital, consultar pag:274
-  Incremento de altura, cada 5cm +5%
-  Freno ralentizado opcional + 120 €

Rango de medida B	G0 Transparente	G1 Mate, Extraclaro, Gris, Bronce	G2 Espejo, Negro
			
Hasta 90	1005	1136	1206
90 - 120	1233	1393	1479

• INSTALACIÓN A PARED

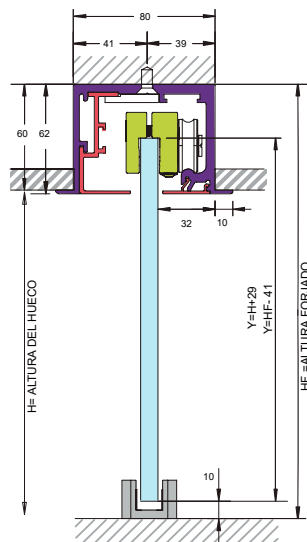

• DETALLE DE LA GUIA

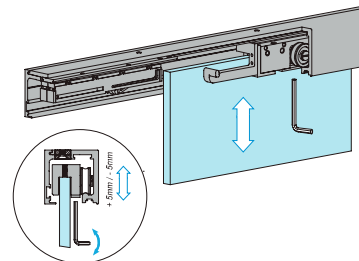

• DIFERENTES SISTEMAS DE FRENOS

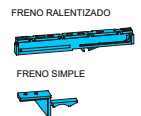

Opciones

Cambio de tirador por uñero +30



Impresión digital personalizada, ver pag:274

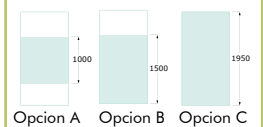



IV2R

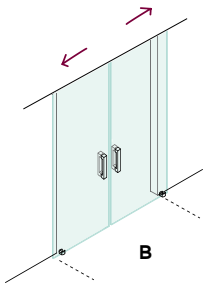

Rango de medida B	G0 Transparente	G1 Mate, Extraclaro, Gris, Bronce	G2 Espejo, Negro
Hasta 180	1873	2116	2247
180 - 2400	2225	2514	2670

Características

- 2 puertas correderas
- Espesor vidrio 10 mm
- Altura 2400.
- Ruedas con ajuste vertical
- Ancho máximo de la puerta 1200 mm
- Peso máximo soportado 150kg
- Impresión digital, consultar pag:274
- Incremento de altura, cada 5cm +5%
- Freno ralentizado opcional + 240 €



• TIRADOR METÁLICO



• UÑERO METÁLICO

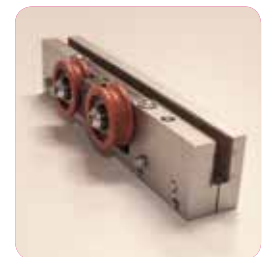

• RODAMIENTO REGULABLE

Opciones

Cambio de tirador por uñero +60	Impresión digital personalizada, ver pag:274
	Opcion A Opcion B Opcion C





INVISIBLE

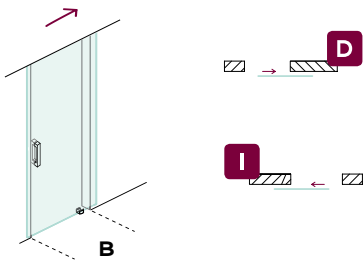



IV2M



Características

-  1 Fijo y 1 puerta corredera
-  Espesor vidrio 10 mm
-  Altura 2400.
-  Ruedas con ajuste vertical
-  Ancho máximo de la puerta 1200 mm
-  Peso máximo soportado 150kg
-  Impresión digital, consultar pag:274
-  Incremento de altura, cada 5cm +5%
-  Freno ralentizado opcional + 120 €

Rango de medida B	G0 Transparente	G1 Mate, Extraclaro, Gris, Bronce	G2 Espejo, Negro
			
Hasta 200	1485	1678	1782
200 - 300	1918	2167	2301

• INSTALACIÓN A PARED

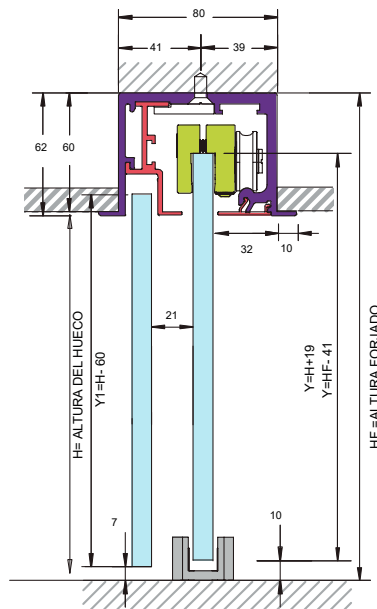

• DETALLE DE LA GUÍA

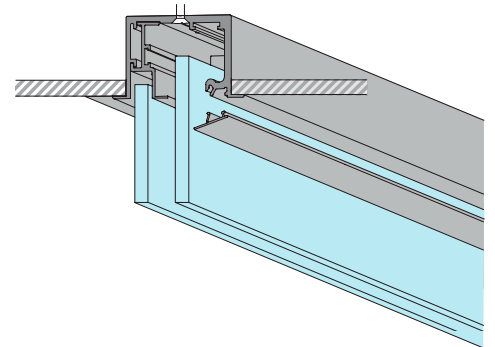

Opciones

Cambio de tirador por uñero +30



Impresión digital personalizada, ver pag:274

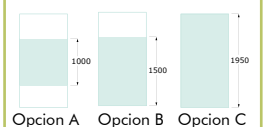



IV4

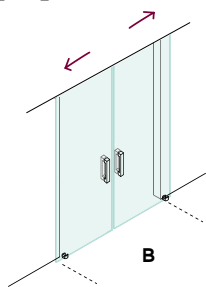

Rango de medida B	G0 Transparente	G1 Mate, Extraclaro, Gris, Bronce	G2 Espejo, Negro
	Hasta 400	2903	3193
400 - 500	3432	3775	4152

Características

- 2 fijos y 2 puertas correderas
- Espesor vidrio 10 mm
- Altura 2400.
- Ruedas con ajuste vertical
- Ancho máximo de la puerta 1200 mm
- Peso máximo soportado 150kg
- Impresión digital, consultar pag:274
- Incremento de altura, cada 5cm +5%
- Freno ralentizado opcional + 240 €



• TIRADOR METÁLICO



• UÑERO METÁLICO

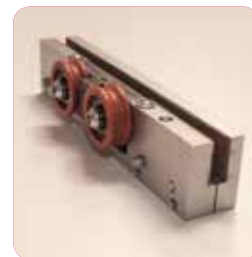

• RODAMIENTO REGULABLE

Opciones

Cambio de tirador por uñero +60



Impresión digital personalizada, ver pag:274

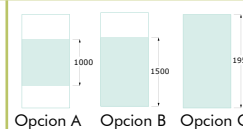

FRAME



FMI

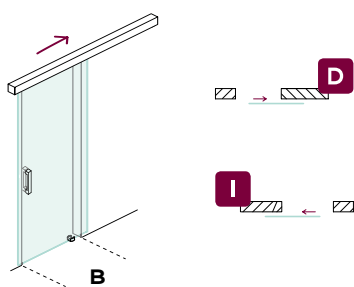

Rango de medida B	G0 Transparente		G1 Mate, Extraclaro, Gris, Bronce		G2 Espejo, Negro	
	M MATE	BLACK LINE	M MATE	BLACK LINE	M MATE	BLACK LINE
Hasta 90	1083	1245	1223	1407	1468	1688
90 - 120	1203	1383	1359	1563	1631	1875

• COLOCACIÓN GUÍA A PARED

• COLOCACIÓN GUÍA A TECHO

• PINZAS DE FIJACIÓN CON FRENO

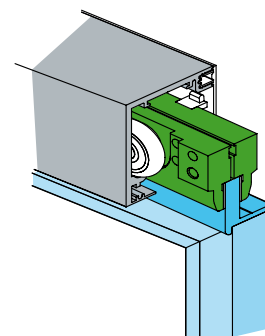
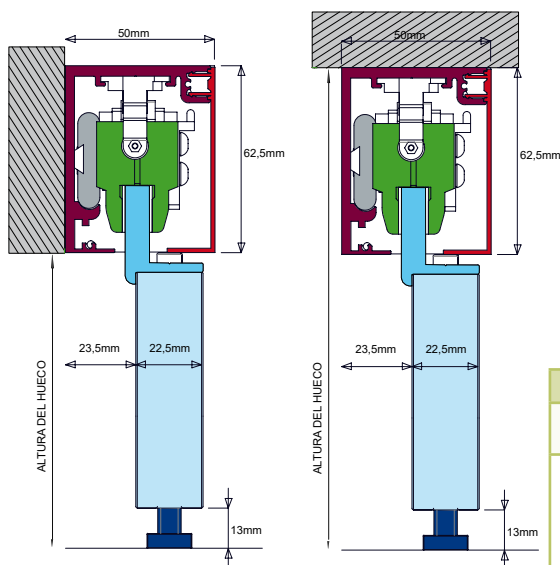

Características

-  Puerta corredera
-  Espesor vidrio 8 mm
-  Altura 2200. Máxima hasta 2500mm
-  Ruedas con ajuste vertical
-  Cierre amortiguado incluido
-  Ancho máximo de la puerta 1200 mm
-  Peso máximo soportado 120kg
-  Impresión digital, consultar pag:274
-  Incremento de altura, cada 5cm +5%

Opciones

Cambio de tirador por uñero +30

Impresión digital personalizada, ver pag:274

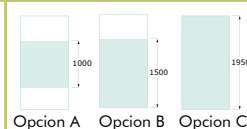



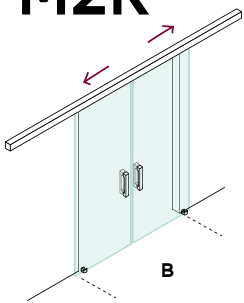

FM2R



Rango de medida B	G0 Transparente		G1 Mate, Extraclaro, Gris, Bronce		G2 Espejo, Negro	
	M MATE	N BLACK LINE	M MATE	N BLACK LINE	M MATE	N BLACK LINE
Hasta 160	1855	2133	2096	2411	2226	2560
160 - 200	2050	2358	2317	2664	2460	2829
200 - 240	2170	2496	2452	2820	2604	2995

Características

-  2 Puertas correderas
-  Espesor vidrio 8 mm
-  Altura 2200. Máxima hasta 2500mm
-  Ruedas con ajuste vertical
-  Cierre amortiguado incluido
-  Ancho máximo de la puerta 1200 mm
-  Peso máximo soportado 120kg
-  Impresión digital, consultar pag:274
-  Incremento de altura, cada 5cm +5%



• TIRADOR METÁLICO



• ENMARCADO DE ALUMINIO



• GUIADOR OCULTO

Opciones

Cambio de tirador por  +60



Impresión digital personalizada, ver pag:274

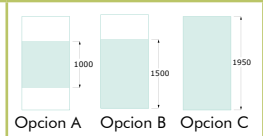

FRAME



FM2M

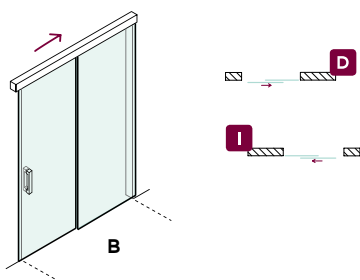

Rango de medida B	G0 Transparente		G1 Mate, Extraclaro, Gris, Bronce		G2 Espejo, Negro	
	M MATE	BLACK LINE	M MATE	BLACK LINE	M MATE	BLACK LINE
Hasta 180	1802	2072	2036	2341	2443	2810
180 - 250	1925	2214	2175	2502	2610	3002

• FRENO CON TOPE Y RALENTIZADO

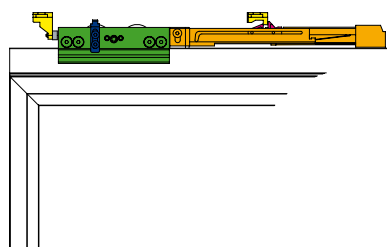

• FRENOS RALENTIZADOS

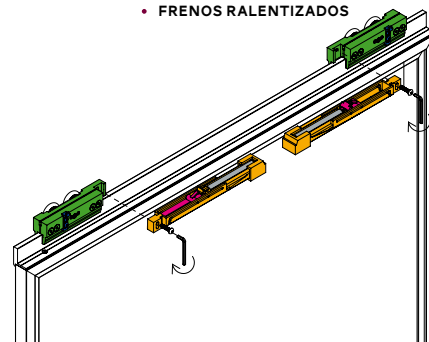

Características

-  1 Fijo y 1 Puerta corredera
-  Espesor vidrio 8 mm
-  Altura 2200. Máxima hasta 2500mm
-  Ruedas con ajuste vertical
-  Cierre amortiguado incluido
-  Ancho máximo de la puerta 1200 mm
-  Peso máximo soportado 120kg
-  Impresión digital, consultar pag:274
-  Incremento de altura, cada 5cm +5%

Opciones

Cambio de tirador por $\text{u}\ddot{\text{u}}\text{n}ero+30$



Impresión digital personalizada, ver pag:274

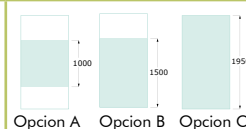



FM4

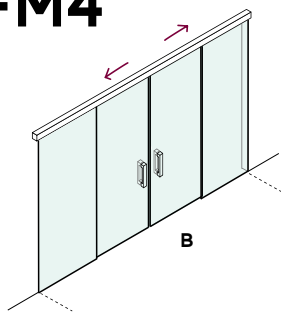

Rango de medida B	G0 Transparente		G1 Mate, Extraclaro, Gris, Bronce		G2 Espejo, Negro	
	M MATE	N BLACK LINE	M MATE	N BLACK LINE	M MATE	N BLACK LINE
Hasta 280	3170	3646	3487	4010	3836	4411
280 - 320	3499	4024	3849	4426	4234	4869
320 - 360	3554	4087	3909	4496	4300	4945
360 - 400	3587	4125	3945	4537	4340	4991

Características

- 2 Fijos y 2 puertas correderas
- Espesor vidrio 8 mm
- Altura 2200. Máxima hasta 2500mm
- Ruedas con ajuste vertical
- Cierre amortiguado incluido
- Ancho máximo de la puerta 1200 mm
- Peso máximo soportado 120kg
- Impresión digital, consultar pag:274
- Incremento de altura, cada 5cm +5%



• TIRADOR METALICO



• ENMARCADO DE ALUMINIO



• GUÍA SOPORTE PARA PINZA

Opciones

Cambio de tirador por uñero+60



Impresión digital personalizada, ver pag:274

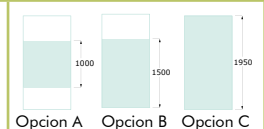

CLICK





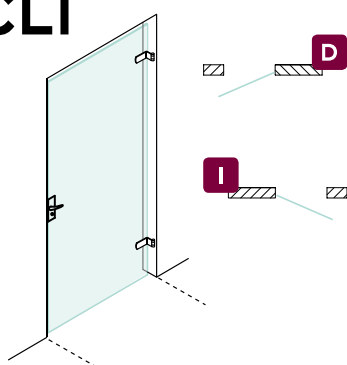





CLI



Rango de medida B	G0 Transparente		G1 Mate, Extraclaro, Gris, Bronce		G2 Espejo, Negro	
	M MATE	BLACK LINE	M MATE	BLACK LINE	M MATE	BLACK LINE
Hasta 90	864	994	976	1123	1037	1192

Características

-  1 puerta abatible 90 °
-  Espesor vidrio 8 mm
-  Altura estándar 2100
-  Ancho máximo de la puerta 900mm
-  Peso máximo soportado 100 kg
-  Impresión digital, consultar pag:274
-  En vidrio de 10mm, PVP+15%
-  Incremento de altura, cada 5cm +5%



• TORNILLERÍA OCULTA



• ACABADOS EN NEGRO Y EN MATE



• **BISAGRAS RECOMENDADAS PARA PUERTAS DE MARCO DE MADERA O METALICAS ,QUE POSEAN GALCE**

• **DETALLE BISAGRAS**

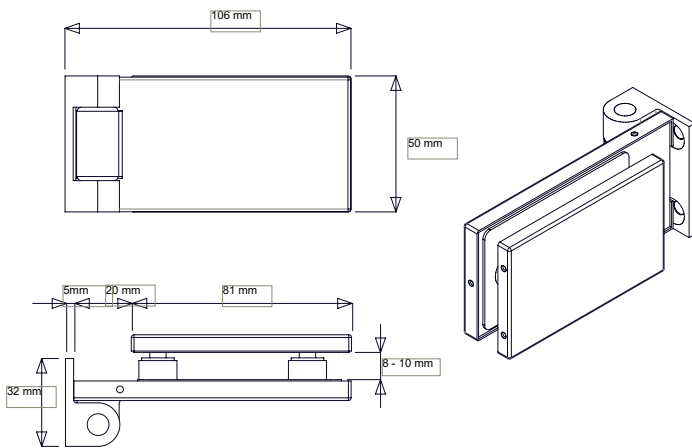

• **DETALLE CERRADURA IMANTADA O CON LLAVE**

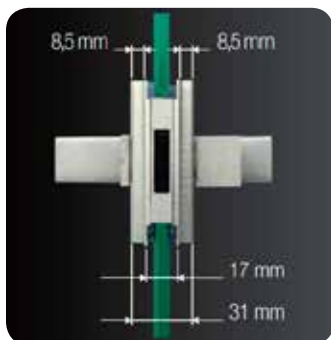
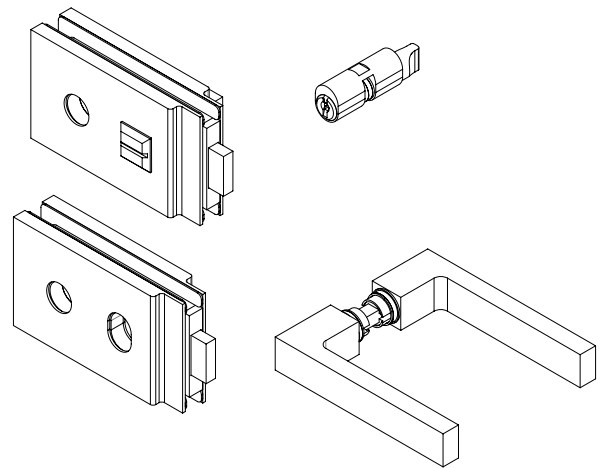

• **MEDIDAS CERRADURA MAGNÉTICA**



• **FRONTAL CERRADURA**



• **CERRADURA DE INETRIOR CON PESTILLO**



• **CERRADURA CON LLAVE DE SEGURIDAD**

PACK



PKI

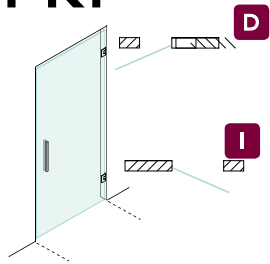

Rango de medida B	G0 Transparente			G1 Mate, Extraclaro, Gris, Bronce			G2 Espejo, Negro		
	B BRILLO	M MATE	BLACK LINE	B BRILLO	M MATE	BLACK LINE	B BRILLO	M MATE	BLACK LINE
Hasta 90	499	574	574	564	649	649	599	689	689

Características

- 1 puerta abatible 180°
- Espesor vidrio 8 mm
- Altura estándar 2100
- Ancho máximo de la puerta 900mm
- Peso máximo soportado 100 kg
- Impresión digital, consultar pag:274
- En vidrio de 10mm, PVP+15%
- Incremento de altura, cada 5cm +5%



• TIRADOR METÁLICO



• ACABADOS EN CROMO BRILLO, NEGRO Y EN MATE



• BISAGRAS CON MEMORIA DE RETENCION 0°, 90° Y 180°



PK2

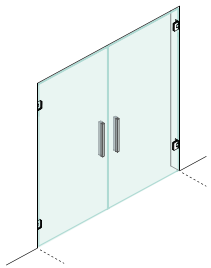

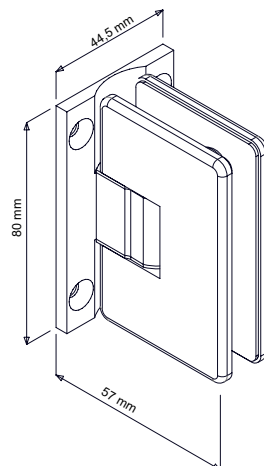

Rango de medida B	G0 Transparente			G1 Mate, Extraclaro, Gris, Bronce			G2 Espejo, Negro		
	 BRILLO	 MATE	 BLACK LINE	 BRILLO	 MATE	 BLACK LINE	 BRILLO	 MATE	 BLACK LINE
Hasta 90	962	1106	1106	1087	1250	1250	1154	1328	1328

• DETALLE BISAGRAS



Características

-  2 puertas abatibles 180 °
-  Espesor vidrio 8 mm
-  Altura estándar 2100
-  Ancho máximo de la puerta 900mm
-  Peso máximo soportado 100 kg
-  Impresión digital, consultar pag:274
-  En vidrio de 10mm, PVP+15%
-  Incremento de altura, cada 5cm +5%

HIDRA



HDI

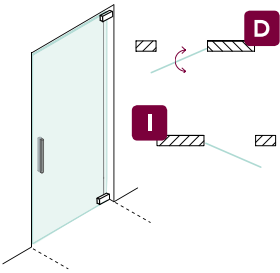

Rango de medida B	G0 Transparente			G1 Mate, Extraclaro, Gris, Bronce			G2 Espejo, Negro		
	B BRILLO	BLACK LINE	C COBRE	B BRILLO	BLACK LINE	C COBRE	B BRILLO	BLACK LINE	C COBRE
Hasta 90	738	848	922	833	958	1042	885	1018	1106

Características

-  1 puerta abatible 130° / -130°
-  Espesor vidrio 10 mm
-  Altura estándar 2100
-  Ancho máximo de la puerta 900mm
-  Peso máximo soportado 100 kg
-  Impresión digital, consultar pag:274
-  Incremento de altura, cada 5cm +5%



• TIRADOR LISBOA



• ACABADOS EN CROMO BRILLO, NEGRO Y COBRE



• BASE REGULABLE



HD2R

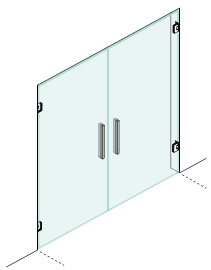

Rango de medida B	G0 Transparente			G1 Mate, Extraclaro, Gris, Bronce			G2 Espejo, Negro		
Hasta 180	1475	1696	1844	1667	1917	2083	1770	2036	2213

• DETALLE BISAGRAS

Características

- 2 puertas abatibles 130° / -130°
- Espesor vidrio 10 mm
- Altura estándar 2100
- Ancho máximo de la puerta 900mm
- Peso máximo soportado 100 kg
- Impresión digital, consultar pag:274
- Incremento de altura, cada 5cm +5%

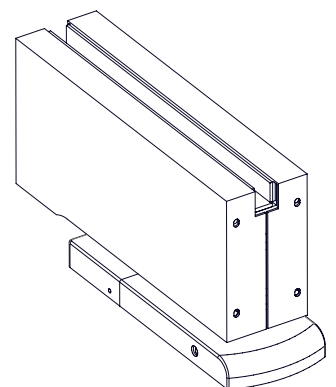
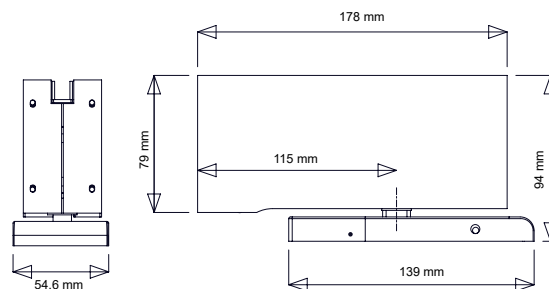

CASSONETTO



CSI

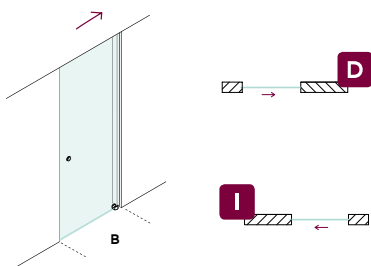

Rango de medida B	G0 Transparente	G1 Mate, Extraclaro, Gris,	G2 Espejo, Negro
Hasta 90	598	675	717

Características

-  1 puerta corredera
-  Espesor vidrio 8 mm
-  Altura estándar 2200
-  Pinzas adaptables a todas las ruedas que usan los cassonetos del mercado
-  Ancho máximo de la puerta 900mm
-  Peso máximo soportado 60kg
-  Impresión digital, consultar pag:274
-  En vidrio de 10mm, PVP+15%
-  Incremento de altura, cada 5cm +5%



• PINZA CON CASSONETTO CLASICO • PINZA CON CASSONETTO OCULTO

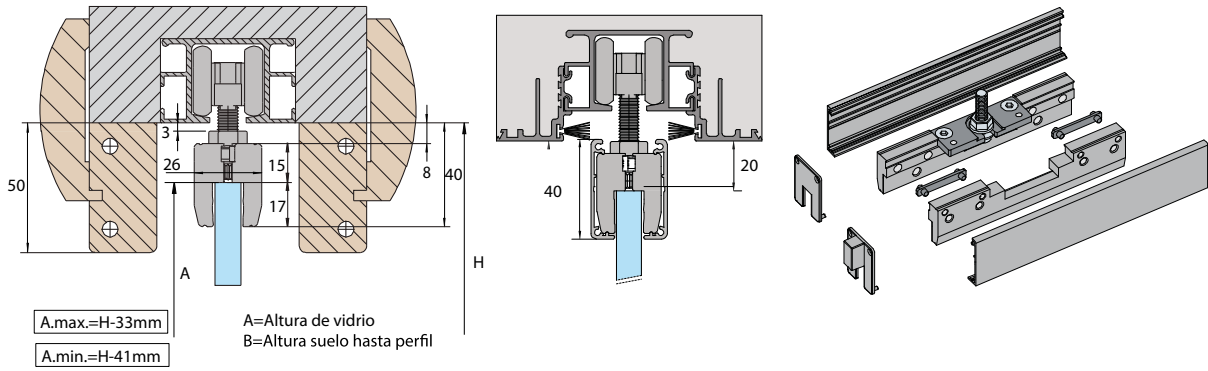

Separadores para vidrio de 8 a 12,76 mm

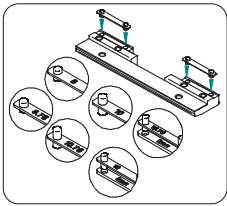

Montaje pinza

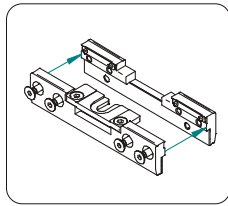

Fijación a vidrio

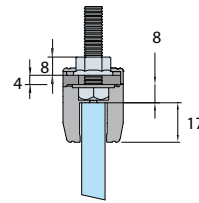
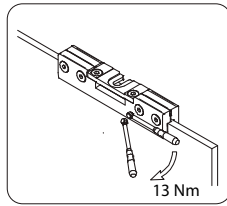

Montaje al perfil del cassonetto

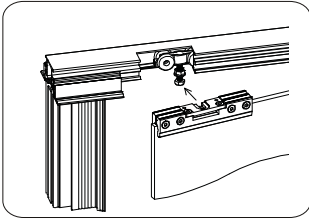

Montaje tapetas embellecedoras

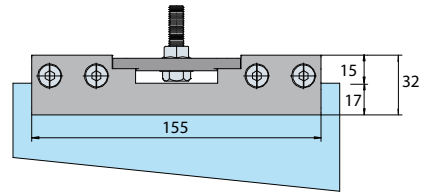
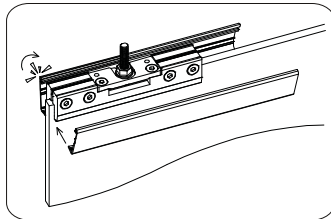

• PISTÓN DE EXPULSIÓN PARA PUERTAS CON UÑERO

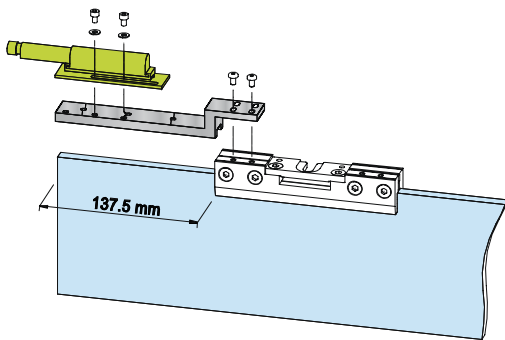

• TOPE DE FINAL DE PUERTA, PARA PUERTAS CON TIRADOR

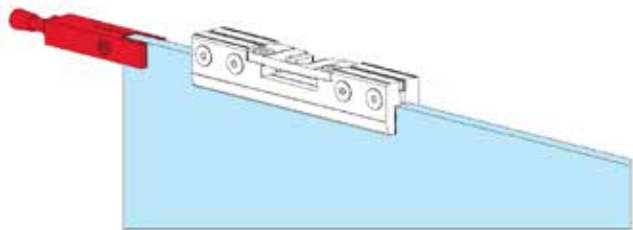

• TIRADOR METÁLICO



• UÑERO METÁLICO



• PINZA SUPERIOR OCULTA



• RODAMIENTO REGULABLE

DATOS TÉCNICOS



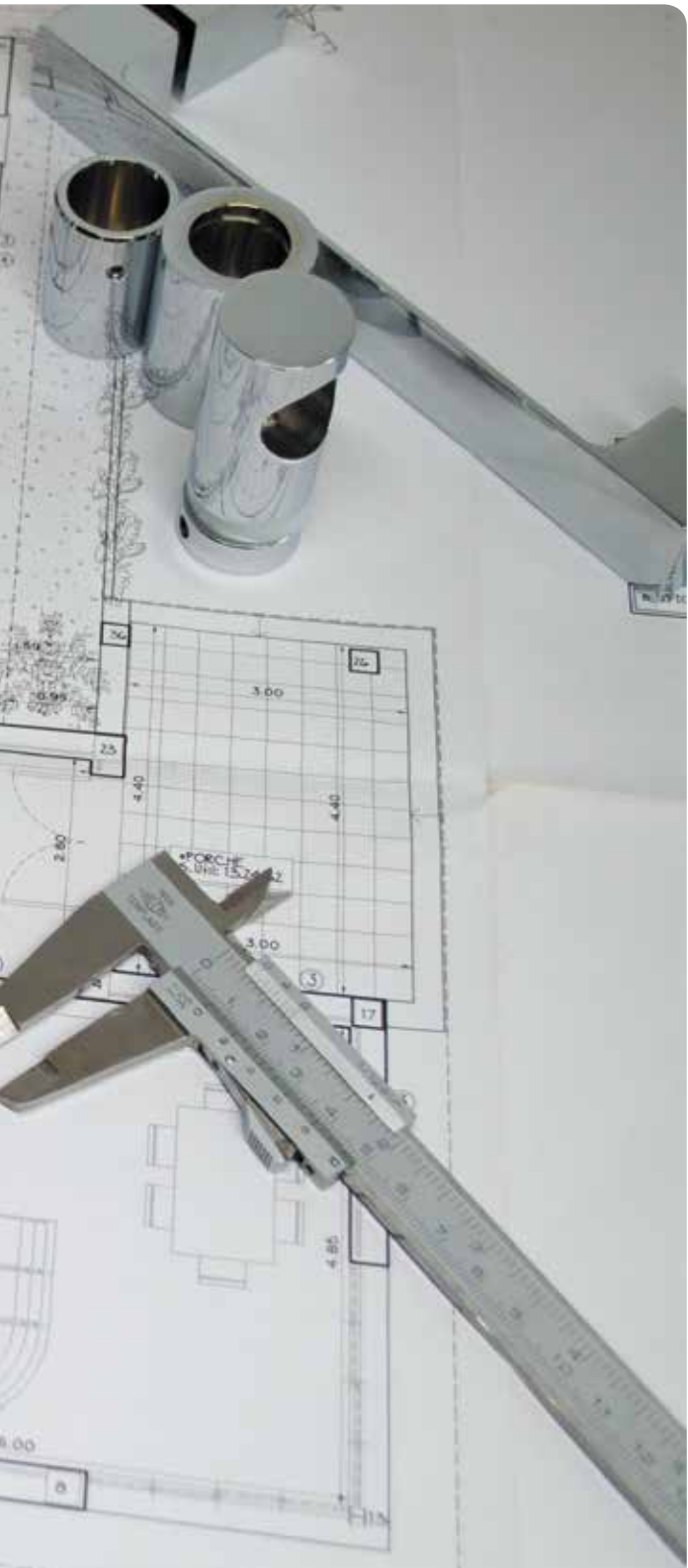

	B BRILLO	SOLID
	B BRILLO	SIDE
	B BRILLO	MOON
	B BRILLO	STAR
	BLACK LINE	WALL
	B BRILLO	SOLID
	B BRILLO	SIDE
	BLACK LINE	MOON
	B BRILLO	SUITE
	B BRILLO	PASS
M MATEADO	B BRILLO	DUNE
M MATEADO	B BRILLO	FORUM
M MATEADO	BLACK LINE	NEXUS
	B BRILLO	INFINITI
	B BRILLO	ROLLING
	BLACK LINE	COMBI
	BLACK LINE	STAR
	B BRILLO	HANDI
	B BRILLO	FLEX
	BLACK LINE	NOVA
	B BRILLO	OPEN
	BLACK LINE	QUADRO
	BLACK LINE	NATURE
M MATEADO		STYLE
M MATEADO	BLACK LINE	NEXUS
	B BRILLO	TECHNICAL
	B BRILLO	ROLLING
M MATEADO		INVISIBLE
M MATEADO	BLACK LINE	FRAME
M MATEADO		CASSONETTO
M MATEADO	BLACK LINE	CLICK
M MATEADO	BLACK LINE	PACK
C COBRE	BLACK LINE	HIDRA
	B BRILLO	DATOS TÉCNICOS DT
		DECORADOS

Piezas de repuesto		B BRILLO Acabado y herrajes en aluminio brillo
	Guía superior aluminio cromado	30ALCR0011
	Perfil expansor 37x26 aluminio cromado	30ALCR0015
	Perfil a pared 37x26 aluminio cromado	30ALCR0017
	Perfil a pared 48x26 aluminio cromado	30ALCR0013
	Junquillo solid embellecedor	30JUTR0001
	Junta imantada plana	30JUTR0003
	Junta imantada a 45°	30JUTR0005
	Junta imantada 90°	30JUTR0009
	Junta de acristalamiento	30JUTR0014
	Junta entre vidrios 15 mm	30JUTR0024
	Tirador doble	30HECR0013
	Rodamiento superior cromado	30HECR0044
	Rodamiento inferior cromado	30HECR0045
	Corner superior para angulares	30HECR0047
	Tapa cubre perfil expansor	30HECR0048
	Tapa cubre perfil magnético	30HECR0049
	Tapa cubre perfil pared	30HECR0050
	Tapa clip guía superior con vidrio	30HECR0051
	Freno guía solid	30HEIN0002

Detalle de medidas

Detalle superior

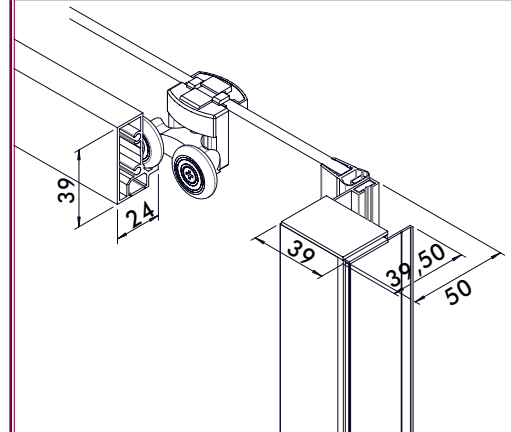

Detalle inferior

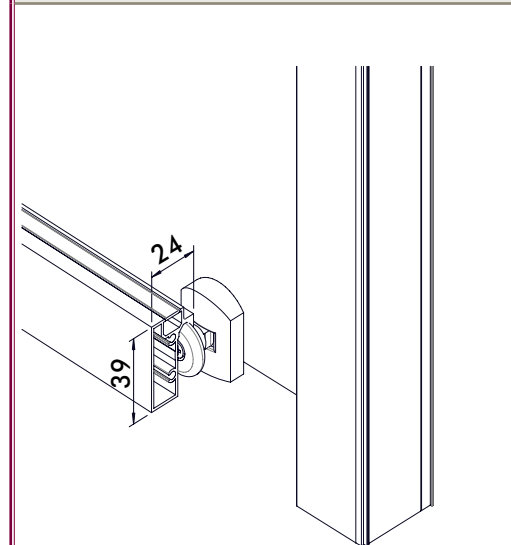

Expansión máxima

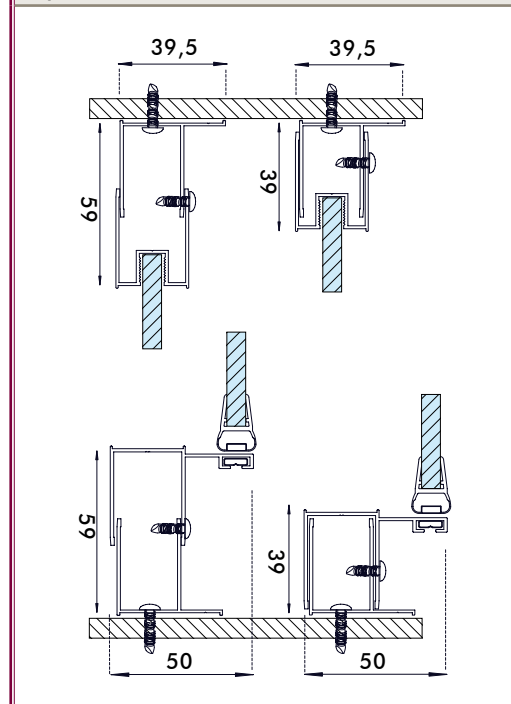

Piezas de repuesto		B BRILLO Acabado y tamaño estándar brillo
	Guía superior aluminio cromado	30ALCR0012
	Perfil expansor 37x26 aluminio cromado	30ALCR0015
	Perfil a pared 37x26 aluminio cromado	30ALCR0017
	Perfil a pared 48x26 aluminio cromado	30ALCR0013
	Perfil macizo de aluminio 6x7 mm	30ALCR0019
	Perfil adhesivo de cierre magnético a pared y vierte aguas	30ALCR0009
	Junta imantada plana	30JUTR0003
	Junta imantada a 45°	30JUTR0005
	Junta imantada 90°	30JUTR0009
	Junta de acristalamiento	30JUTR0014
	Junta entre vidrios 15 mm	30JUTR0024
	Junta vierteaguas	30JUTR0011
	Junta de acristalamiento	30JUTR0035
	Tirador doble	30HECR0013
	Rodamiento superior cromado	30HECR0046
	Corner superior para angulares	30HECR0047
	Tapa cubre perfil expansor	30HECR0048
	Tapa cubre perfil magnético	30HECR0049
	Tapa cubre perfil pared	30HECR0050
	Freno regulable guía side	30HEGS0003
	Guiador inferior	30HECR0087
	Embellecedor de vierte aguas	30HECR0085
	Soporte fijación guía a pared derecha	30HECR0089
	Soporte fijación guía a pared izquierda	30HECR0088
	Esquinero inferior angular	30HECR0090
	Tira de imán estanca	30JUNE0001

Detalle de medidas

Detalle superior

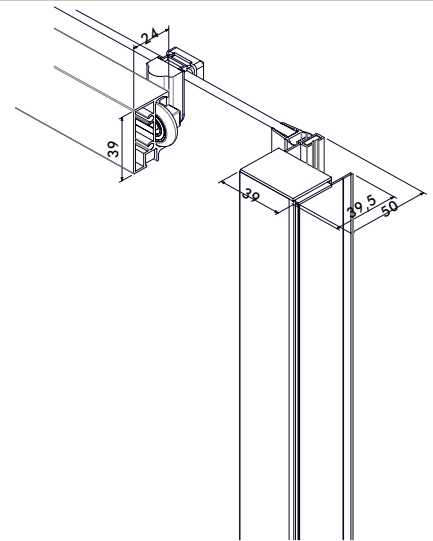

Detalle inferior

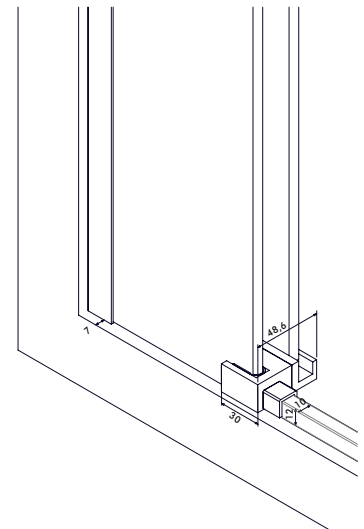

Expansión máxima

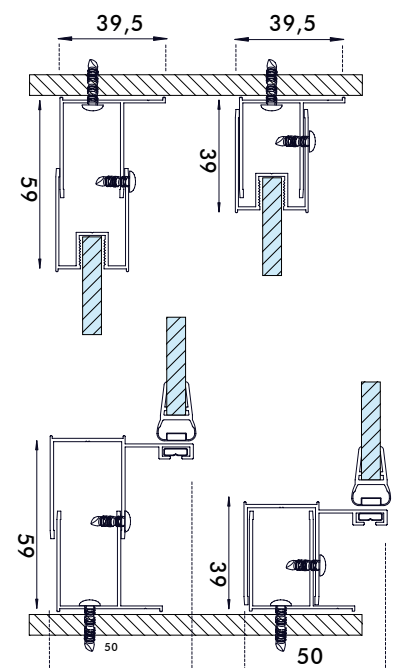

Piezas de repuesto		B BRILLO Perfiles y herrajes acabados brillo	N BLACK LINE Perfiles y herrajes acabados negro
	Guía superior aluminio cromado	30ALCR0012	30ALNM0012
	Perfil expansor 25x 9,6 aluminio cromado	30ALCR0022	30ALNM0022
	Perfil adhesivo de cierre magnético a pared y vierte aguas	30ALCR0009	30ALNM0009
	Perfil macizo de aluminio 6x7 mm	30ALCR0019	30ALNM0019
	Embellecedor de vierte aguas	30HECR0085	30HENM0043
	Junta imantada plana	30JUTR0003	-
	Junta imantada a 45°	30JUTR0005	-
	Junta imantada 90°	30JUTR0009	-
	Junta entre vidrios 15 mm	30JUTR0024	-
	Junta vierteaguas	30JUTR0011	-
	Junta de acristalamiento	30JUTR0035	
	Tirador doble de acero inox	30HECR0013	30HENM0013
	Rodamiento superior cromado	30HECR0046	30HENM0046
	Corner superior para angulares	30HECR0047	30HENM0047
	Freno regulable guía side	30HEGS0003	-
	Guiador inferior metálico	30HECR0087	30HENM0087
	Soporte fijación guía a pared DCH	30HECR0089	30HENM0089
	Soporte fijación guía a pared IZQ	30HECR0088	30HENM0088
	Embellecedor soporte a pared	30HECR0086	30HENM0046
	Esquinero inferior angular	30HECR0090	30HENM0047

Detalle de medidas

Detalle superior

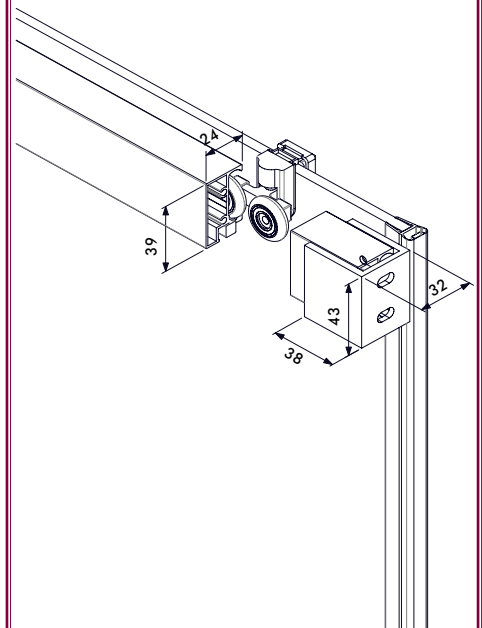

Detalle inferior

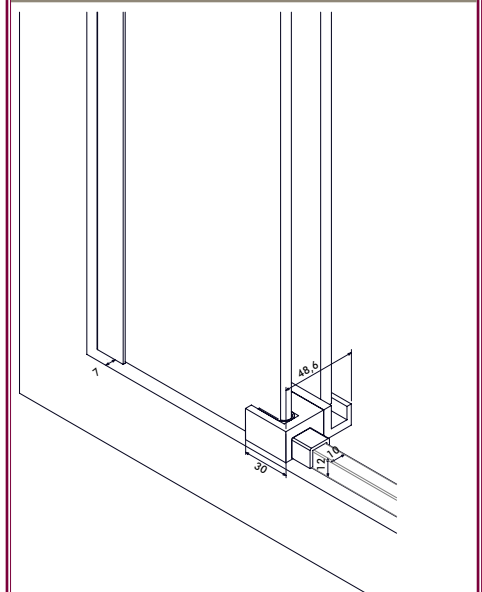

Expansión máxima

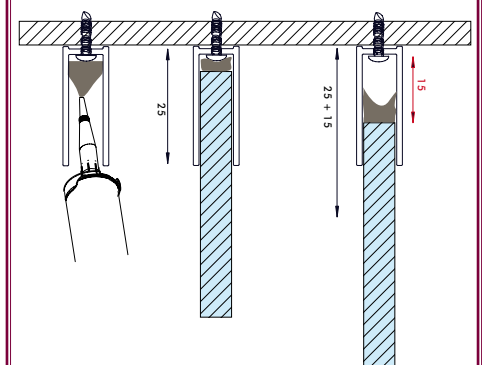

Piezas de repuesto		B BRILLO Pintado y herrajes acabados brillo	N BLACK LINE Pintado y herrajes acabados negro
	Vierteaguas /cierre lateral	30ALCR0005	30ALNM0005
	Perfil expansor 25x11 para 8mm	30ALCR0020	30ALNM0001
	Perfil U 33x24	30ALCR0001	30ALNM0026
	Perfil 23x8 para 6mm	30ALCR0024	30ALNM0024
	Perfil cierre magnético a pared	30ALCR0009	30ALNM0009
	Perfil giratorio cromado	30ALCR0028	30ALNM0028
	Perfil fijo giratorio cromado	30ALCR0030	30ALNM0030
	Barra rectangular	30INPU0004	30INNM0004
	Junta imantada plana	30JUTR0003	-
	Junta imantada a 45°	30JUTR0005	-
	Junta imantada 90°	30JUTR0009	-
	Junta vierteaguas	30JUTR0011	-
	Junta mini de solape	30JUTR0040	-
	Junta de perfil angular	30JUTR0042	-
	Tira de imán estanca	30JUNE0001	-
	Casquillo elevador	30HECR0035	-
	Punto de giro izquierda	30HECR0036	30HENM0036
	Tapa superior perfil giratorio	30HEGS0001	-
	Punto de giro derecha	30HECR0037	30HENM0037
	Tapa inferior perfil giratorio	30HEGS0002	-
	Calzo batientes 6/8 mm	30HEGS0004	-
	Tirador doble de acero inox	30HECR0013	30HENM0013
	Tapa vierteaguas lateral derecho	30HECR0003	30HENM0103
	Tapa vierteaguas lateral izquierdo	30HECR0004	30HENM0004
	Juego tapa vierteaguas c	30HECR0008	30HENM0108
	tapa angular vierteaguas	30HECR0009	30HENM0109
	Pinza frontal inox pulido	30HEPU0001	30HENM0011
	Pinza lateral inox pulido	30HEPU0002	30HENM0022
	Tapa pinza lateral inox pulido	30HEPU0003	30HENM0003
	Esquinero Barra 20x10	30HEPU0007	30HENM0007
	Sujeción pared-Barra 20x10	30HEPU0009	30HENM0009
	Anclaje sujeción pared barra	30HEPU0010	-
	Barra de refuerzo SR01	30HEPU0022	30HENM0122
	Bisagra Quadro Vidrio-vidrio 50x50	30HEPU0043	30HENM0143
	Pomo cónico Ø 40 cromado	30HECR0017	30HENM0017

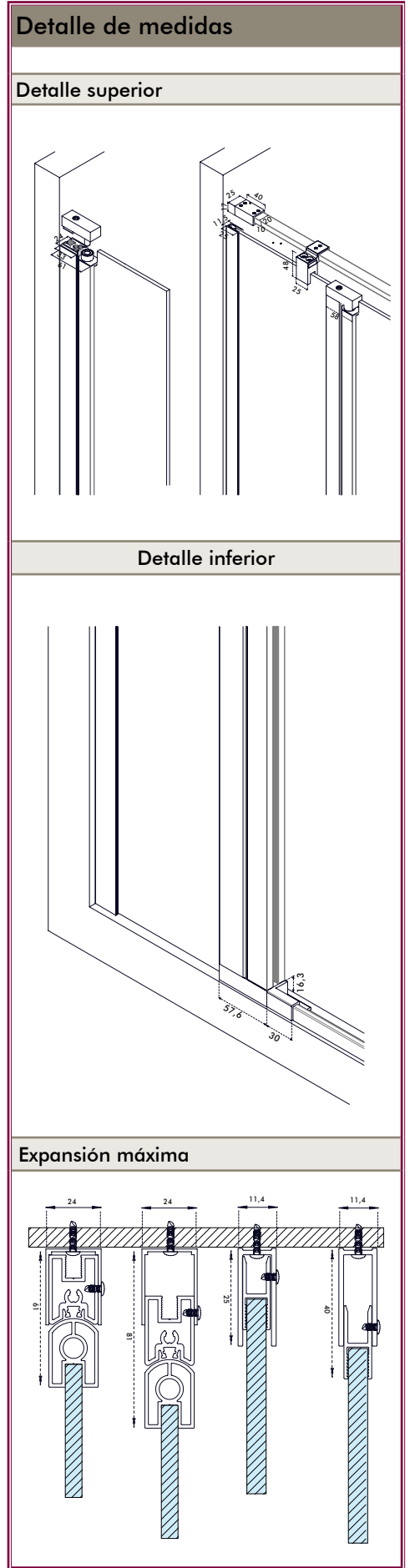

Piezas de repuesto		B BRILLO	BLACK LINE
	Perfil expansor 25x11 aluminio para 8 mm	30ALCR0020	30ALNM0001
	Perfil expansor 25x9 aluminio para 6mm	30ALCR0022	30ALNM0022
	Perfil 23x8 para 6mm	30ALCR0024	30ALNM0024
	Junta de acristalamiento	30JUTR0035	-
	Junta barrido de 22mm	30JUTR0032	-
	Junta entre perfil giratorio	30JUTR0042	-
	Casquillo elevador Star cromado	30HECR0035	-
	Punto de giro Star izda cromado	30HECR0036	30HENM0036
	Tapa superior perfil giratorio Star	30HEGS0001	-
	Punto de giro Star dcha cromado	30HECR0037	30HENM0037
	Tapa inferior perfil giratorio Star	30HEGS0002	-
	Perfil giratorio cromado	30ALCR0028	30ALNM0028
	Perfil fijo giratorio cromado	30ALCR0030	30ALNM0030
	Conector en cruz barras de seguridad, inox pulido.	30HEPU0049	-
	Barra de seguridad extensible inox pulido. (650 -1100)	30HEPU0048	30HENE0048

Detalle de medidas

Detalle superior

Para 6 mm

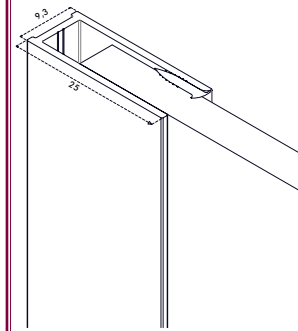

Para 8 mm

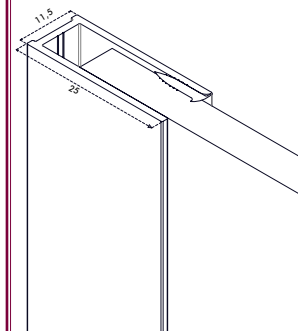

Detalle inferior

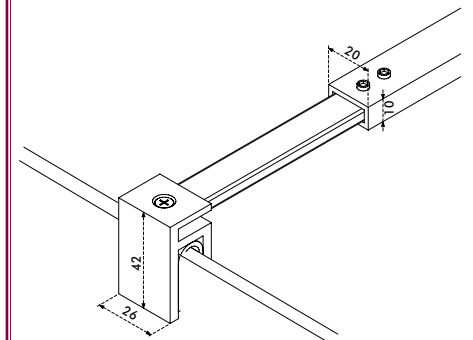



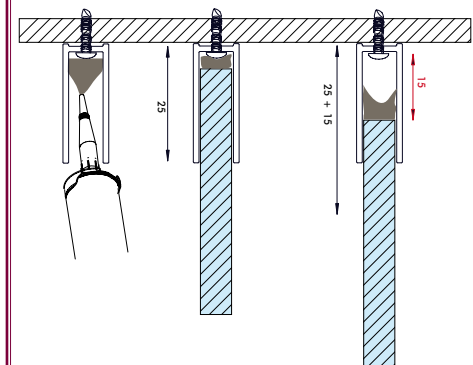



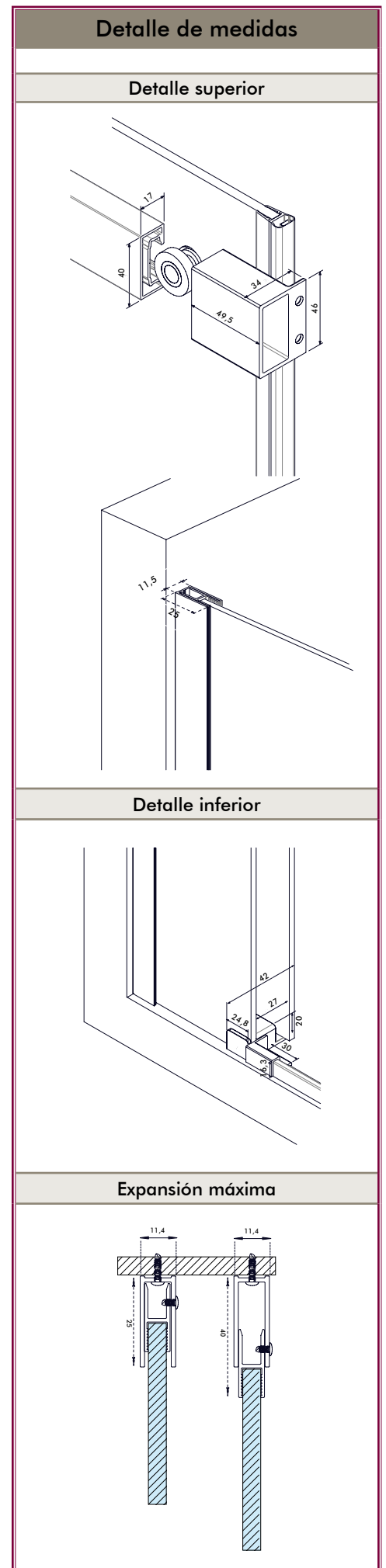











Expansión máxima









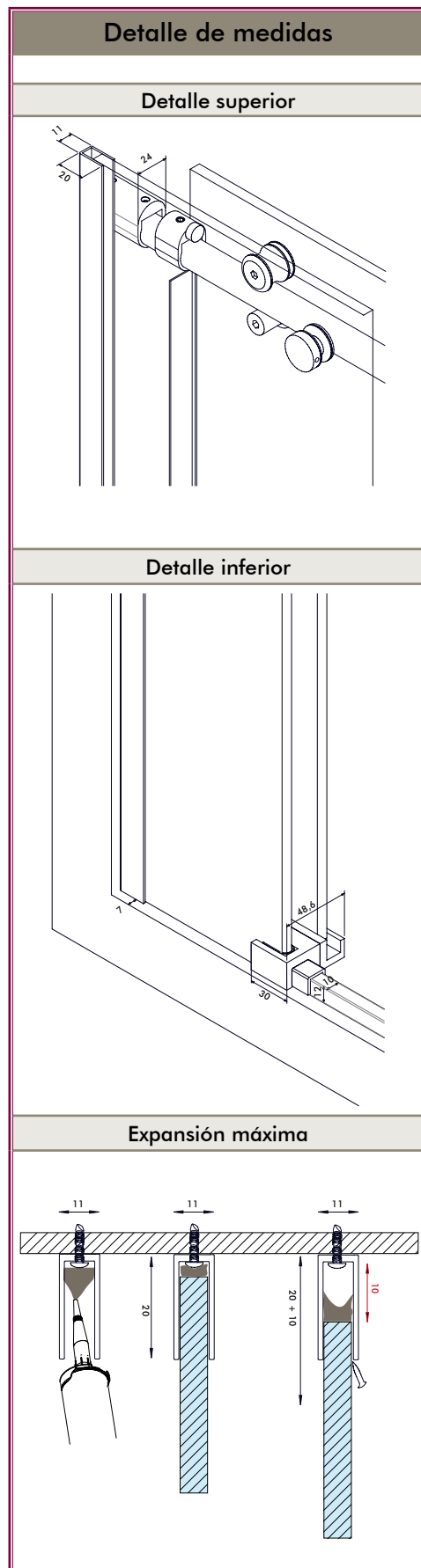









Piezas de repuesto		B BRILLO Pantallas y herrajes acabados brillo
	Vierteaguas /cierre lateral cromado	30ALCR0005
	Perfil expansor 25x11 aluminio cromado para 6mm	30ALCR0020
	Perfil h 23x8 cromado para 6mm	30ALCR0024
	Perfil adhesivo de cierre magnético a pared	30ALCR0009
	Guía superior cromada	30ALCR0006
	Junta doble vidrio 8mm	30JUIIN0003
	Junta imantada plana	30JUTR0003
	Junta burbuja	30JUTR0020
	Junta imantada a 45°	30JUTR0005
	Junta vierteaguas	30JUTR0011
	Junta entre vidrios	30JUTR0012
	Guiador inferior	30HECR0005
	Tira de imán	30JUNE0001
	Pomo acero inox	30HEPU0011
	Tapa de final de barra superior	30HECR0010
	Tapa vierteaguas fijo lateral derecha cromado	30HECR0003
	Tapa vierteaguas fijo lateral izquierdo cromado	30HECR0004
	Juego tapa vierteaguas cromado	30HECR0008
	tapa angular vierteaguas cromado	30HECR0009
	Rueda excéntrica	30HEPU0014
	Tope barra suite	30HEPU0017
	Esquinero guía superior	30HEPU0018
	Sujeción pared guía	30HEPU0019
	Terminación guía con vidrio	30HEPU0020
	SopORTE barra cristal	30HEPU0021



Piezas de repuesto		B BRILLO Perfiles y herrajes acabados brillo	M MATE Perfiles y herrajes acabados mate
	Perfil expansor 20x11 acero inox	30INPU0010	30INSA0010
	Barra redonda guía superior	30INPU0006	30INSA0006
	Barra de acero inox 10x12x1.5 mm	30INPU0009	30HESA0009
	Perfil adhesivo de cierre magnético a pared,	30ALCR0009	30ALPM0009
	Junta doble vidrio 8mm	30JUIN0003	-
	Tira de imán estanca	30JUNE0001	-
	Junta imantada plana	30JUTR0003	-
	Junta burbuja	30JUTR0020	-
	Junta vierteaguas	30JUTR0011	-
	Junta de perfil entre vidrios	30JUTR0012	-
	Junta de acristalamiento	30JUTR0035	-
	Pomo acero inox	30HEPU0011	30HESA0011
	Rueda barra redonda inox	30HEPU0016	30HESA0016
	Anti vuelco Inox	30HEPU0031	30HESA0031
	Soporte barra-vidrio redondo inox	30HEPU0030	30HESA0030
	Soporte barra cristal	30HEPU0021	30HESA0021
	Freno barra redonda inox	30HEPU0023	30HESA0023
	Soporte pared redondo inox	30HEPU0029	30HESA0029
	Guiador inferior metálico inox	30HEPU0050	30HESA0050
	Embellecedor suelo acero inox	30HEPU0043	30HESA0043
	Esquinero suelo inox	30HEPU0008	30HESA0008



Piezas de repuesto		M MATE Perfiles y herrajes acabados mate	BLACK LINE Perfiles y herrajes acabados negro	B BRILLO Perfiles y herrajes acabados brillo
	Perfil expansor 25X15	30ALPM0007	30ALNM0007	30ALCR0007
	Perfila rectangular vierteaguas	30ALPM0036	30ALNM0036	30ALCR0036
	Guía superior Nexus	30ALPM0045	30ALNM0045	30ALCR0045
	Tapa guía Nexus	30ALPM0046	30ALNM0046	30ALCR0046
	Tapeta ranura fijo Nexus	30ALPM0047	30ALNM0047	30ALCR0047
	Junta imantada 45°	30JUTR0005	-	-
	Junta imantada plana	30JUTR0003	-	-
	Junta burbuja	30JUTR0020	-	-
	Junta doble vidrio 8mm	30JUIN0004	-	-
	Junta acristalar 25x15	30JUTR0017	-	-
	Junta entre vidrios	30JUTR0046	-	-
	Junta de acristalamiento	30JUTR0034	-	-
	Tirador doble metálico 184 mm	30HEPM0012	30HENM0012	30HECR0012
	Juego anclaje guía Nexus	30HEPM0053	-	-
	Juego freno completo	30HEPM0055	-	-
	Juego pinzas Nexus 75 kg	30HEPM0054	-	-
	Tapeta lateral Nexus derecha	30HEPM0056	30HENM0056	30HECR0056
	Tapeta lateral Nexus izquierda	30HEPM0057	30HENM0057	30HECR0057
	Embellecedor Lateral Nexus	30HEPM0058	30HENM0058	30HECR0058
	Ángulo Superior Nexus	30HEPM0062	30HENM0062	30HECR0062
	Guiador inferior con acople de perfil vierteaguas	30HEPM0059	30HENM0059	
	Tapa tubo rectangular Nexus	30HEPM0060	30HENM0060	
	Ángulo inferior Nexus vierteaguas	30HEPM0061	30HENM0061	
	Juego topes freno	30HEPM0084	-	-
	Perfiles guía propileno	30JUBL0001	-	-

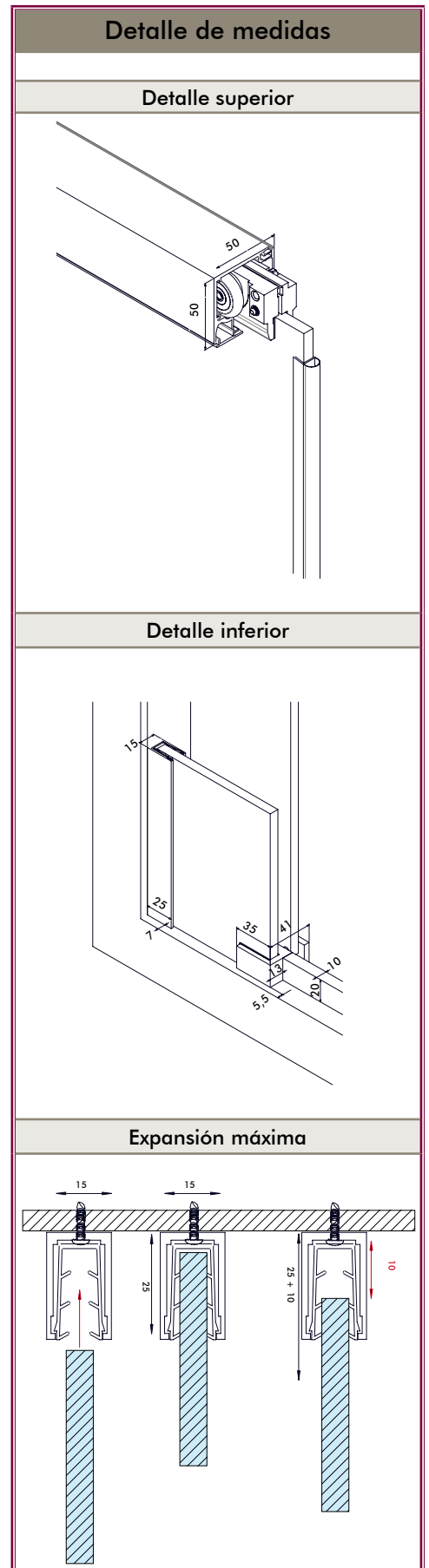

Piezas de repuesto		B BRILLO Perfiles y herrajes acabados brillo
	Perfil expansor 25X15	30ALCR0008
	Perfil adhesivo de cierre magnético a pared,	30ALCR0009
	Vierteaguas	30ALCR0005
	Tira de imantada estancia	30JUNE0001
	Junta imantada plana	30JUTR0003
	Junta imantada a 45°	30JUTR0005
	Junta burbuja	30JUTR0020
	Junta acristalar 25x15	30JUTR0017
	Junta de perfil entre vidrios	30JUTR0026
	Tirador doble de 29cm	30HECR0011
	KIT guía superior Perfil guía superior Tapa del perfil guía superior Tapeta inferior	30ALPM0001 30ALPM0002 30ALPM0003
	Tapa vierteaguas fijo lateral derecha cromado	30HECR0003
	Tapa vierteaguas fijo lateral izquierdo cromado	30HECR0004
	Juego tapa vierteaguas cromado	30HECR0008
	Tapa angular vierteaguas cromado	30HECR0009
	KIT accesorios infiniti para 20 kg	30HEPM0004
	KIT accesorios infiniti para 40 kg	30HEPM0005
	KIT accesorios de montaje Sujeción a pared y cuñas de montaje	30HEPM0006
	Conector angular infiniti	30HEPM0007

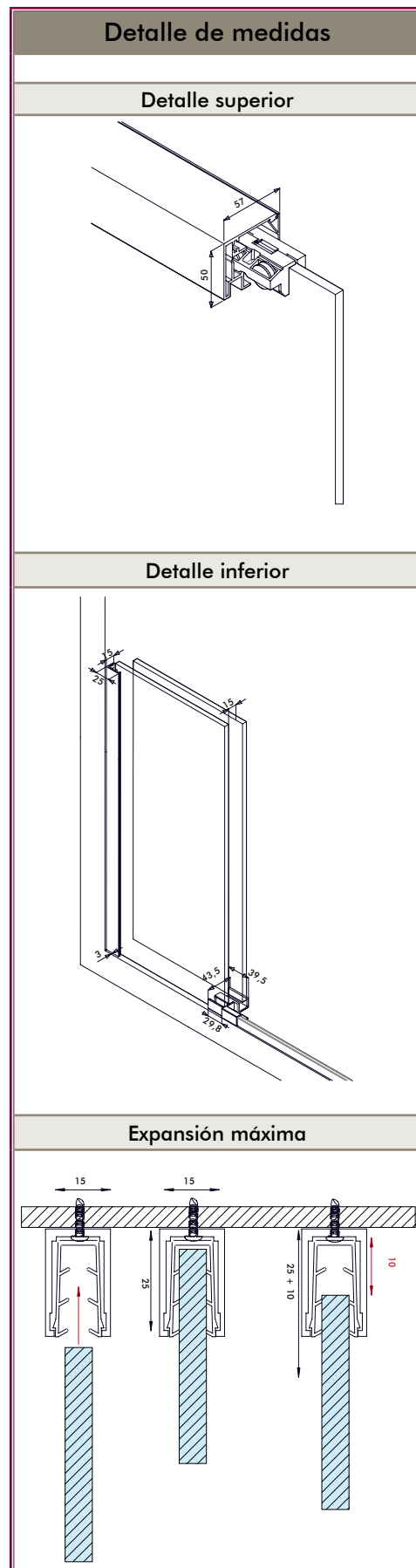

Piezas de repuesto		B BRILLO <small>Perfiles y herrajes acabados brillo</small>
	Perfil "U" 33x24 (solo para flex de 8mm)	30ALCR0001
	Perfil expansor 30x21 (solo para flex de 8mm)	30ALCR0003
	Vierteaguas /cierre lateral	30ALCR0005
	Barra rectangular 20x10	30INPU0004
	Perfil vierteaguas adhesivo	30JUCR0001
	Junta imantada plana	30JUTR0003
	Junta imantada a 45°	30JUTR0005
	Junta vidrios bisagra	30JUTR0002
	Junta pared 3,8	30JUTR0030
	Junta de barrido 22mm	30JUTR0032
	Tirador doble metálico 184mm	30HECR0012
	Calzo batientes 6/8 mm	30HEGS0004
	Pinza frontal acero inox	30HEPU0001
	Pinza lateral acero inox	30HEPU0002
	Tapa pinza lateral inox pulido	30HEPU0003
	Esquinero Barra 20x10	30HEPU0007
	Sujeción pared-Barra 20x10 acero inox	30HEPU0009
	Anclaje sujeción pared barra	30HEPU0010
	Soporte perpendicular barra 20x10 acero inox	30HEPU0039
	Bisagra Open Superior derecha	30HECR0028
	Bisagra Open Inferior izquierda	30HECR0029
	Tapa perfil expansor 30x21(solo para flex de 8mm)	30HECR0007

Detalle de medidas

Detalle superior

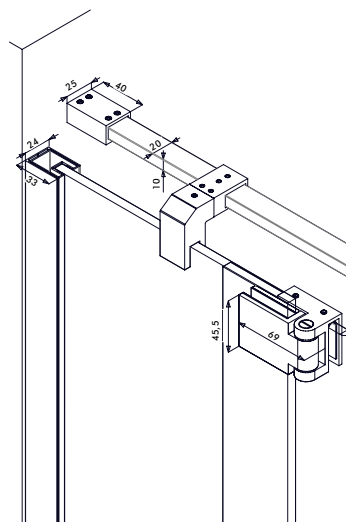

Detalle inferior

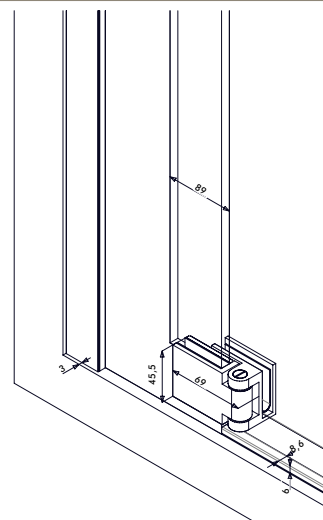

Expansión máxima

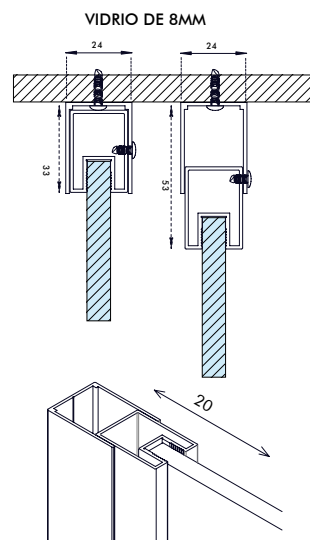

Piezas de repuesto		B BRILLO Pulido y herrajes acabados brillo	N BLACK LINE Pulido y herrajes acabados negro
	Perfil "U" 33x24 (solo para flex de 8mm)	30ALCR0001	30ALNM0026
	Perfil expansor 30x21 (solo para flex de 8mm)	30ALCR0003	30ALNM0003
	Tapa perfil expansor 30x21 (solo para flex de 8mm)	30HECR0007	30HENM0107
	Perfil expansor 25x11	30ALCR0020	30ALNM0001
	Perfil expansor imán	30ALCR0064	30ALNM0064
	Tapeta superior perfil imán	30HECR0084	30HENM0084
	Vierteaguas /cierre lateral	30ALCR0005	30ALNM0005
	Perfil H 23x8 para 6mm	30ALCR0024	30ALNM0024
	Barra rectangular 20x10	30INPU0004	30INNM0004
	Junta imantada plana	30JUTR0003	-
	Junta imantada a 45°	30JUTR0005	-
	Junta imantada 90°	30JUTR0009	-
	Junta vierteaguas	30JUTR0011	-
	Junta a pared Quadro	30JUTR0044	-
	Junta vidrios bisagra	30JUTR0002	-
	Tira de imán estanca	30JUNE0001	-
	Tirador doble de acero inox	30HEPU0013	30HENM0013
	Tapa vierteaguas fijo lateral derecha cromado	30HECR0003	30HENM0103
	Tapa vierteaguas fijo lateral izquierdo cromado	30HECR0004	30HENM0004
	Juego tapa vierteaguas cromado	30HECR0008	30HENM0108
	Tapa angular vierteaguas cromado	30HECR0009	30HENM0109
	Calzo batientes 6/8 mm	30HEGS0004	-
	Pinza frontal acero inox	30HEPU0001	30HENM0011
	Pinza lateral acero inox	30HEPU0002	30HENM0022
	Tapa pinza lateral inox pulido	30HEPU0003	30HENM0003
	Esquinero Barra 20x10	30HEPU0007	30HENM0007
	Sujeción pared-Barra 20x10 acero inox	30HEPU0009	30HENM0009
	Anclaje sujeción pared barra	30HEPU0010	-
	Barra de refuerzo SR01	30HEPU0022	30HENM0022
	Bisagra Quadro Vidrio-muro 50x50	30HEPU0042	30HENM0042
	Bisagra Quadro Vidrio-vidrio 50x50	30HEPU0043	30HENM0143

Detalle de medidas

Detalle superior

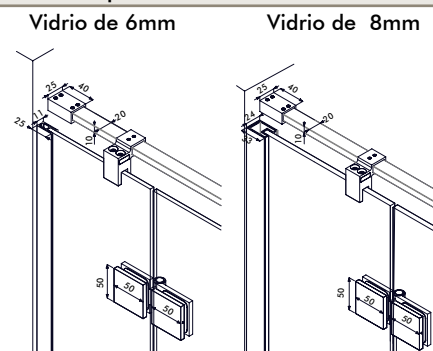

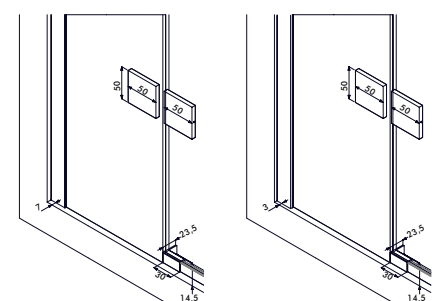

Detalle inferior

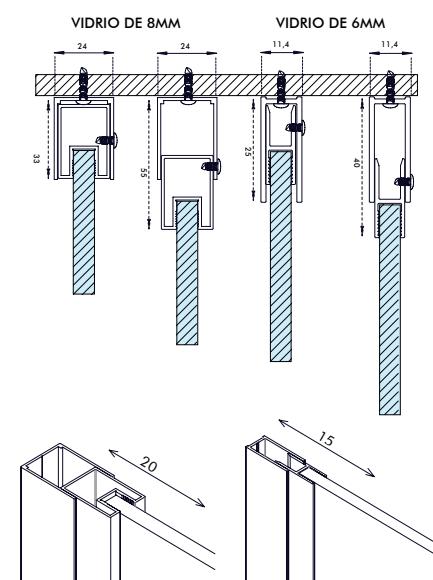

Expansión máxima



Piezas de repuesto		B BRILLO Perfiles y herrajes acabados brillo	N BLACK LINE Perfiles y herrajes acabados negro
	Perfil expansor 25x11	30ALCR0020	30ALNM0001
	Perfil expansor 25X15	30ALPM0007	30ALNM0007
	Perfil h 23x8 cromado para 6mm	30ALCR0024	30ALNM0024
	Perfil giratorio cromado	30ALCR0028	30ALNM0028
	Perfil fijo giratorio cromado	30ALCR0030	30ALNM0030
	Junta acristalar para 6mm ,1950mm	30JUTR0015	-
	Junta acristalar para 8mm ,1950mm	30JUTR0017	-
	Junta doble vidrio 8mm	30JUIN0003	-
	Barra rectangular 20x10	30INPU0004	30INNM0004
	Junta de perfil angular	30JUTR0042	-
	Tapa superior perfil 25x15	30HECR0002	30HENM0002
	Casquillo elevador	30HECR0035	-
	Punto de giro izquierda	30HECR0036	30HENM0036
	Tapa superior perfil giratorio	30HEGS0001	-
	Punto de giro derecha	30HECR0037	30HENM0037
	Tapa inferior perfil giratorio	30HEGS0002	-
	Rótula barra techo	30HECR0053	-
	Rótula barra Suelo	30HECR0054	-
	Rótula barra vidrio	30HECR0055	-
	Barra redonda Nova/NT Ø22	30INPU0007	-
	Pinza frontal acero inox	30HEPU0001	30HENM0011
	Pinza lateral acero inox	30HEPU0002	30HENM0022
	Tapa pinza lateral acero inox	30HEPU0003	30HENM0003
	Esquinero Barra 20x10 acero inox	30HEPU0007	30HENM0007
	Sujeción pared-Barra 20x10 acero inox	30HEPU0009	30HENM0009
	Anclaje sujeción pared barra acero inox	30HEPU0010	-

Detalle de medidas

Detalle superior e inferior

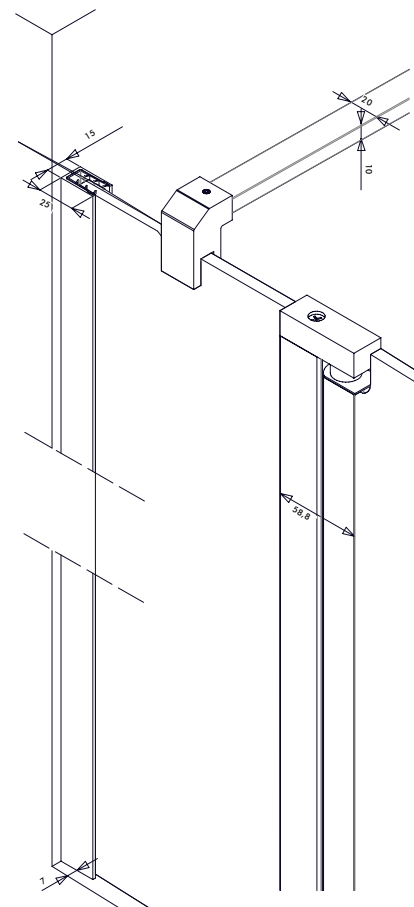

Expansión máxima

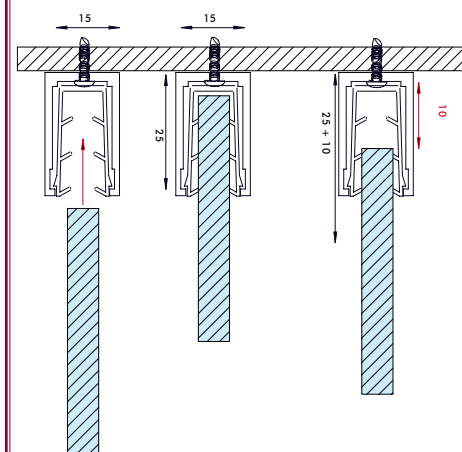

Piezas de repuesto		B BRILLO <small>Acabado y herrajes acabados brillo</small>
	Guía inferior de aluminio cromado	KITDO100
	Guía superior de aluminio cromado	KITTRL100
	Perfila a pared	
	Junta burbuja	30JUTR0020
	Junta imantada plana	30JUTR0003
	Junta entre vidrios	KITTR100
	Perfil adhesivo de cierre magnético a pared	30ALCR0009
	Junta inferior de guiado de puertas	KITTR100
	Junta vierteaguas	KITTR100
	Guiador triple	KITTR100
	Guiador doble	KITDO100
	Sujeción de vidrio con guía	KITTR100
	Soporte fijación guía a pared derecha	KITDO100
	Soporte fijación guía a pared izquierda	KITDO100
	Carro de ruedas superiores de vidrio interior	KITTR100
	Carro de ruedas superiores	KITTR100
	Vierteaguas	KITTR100
	Embellecedor de vierteaguas	KITTR100
	Uñero de 55mm	30HECR0019
	Tirador metálico	30HECR0013

Detalle de medidas

Detalle superior e inferior

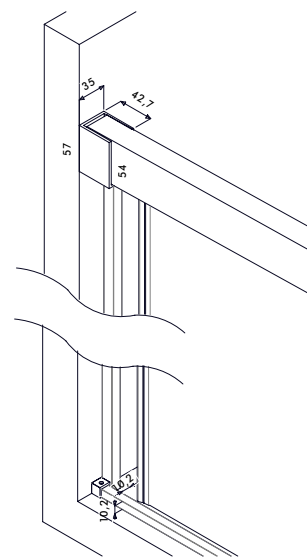

Expansión máxima

GUIADOR TRIPLE

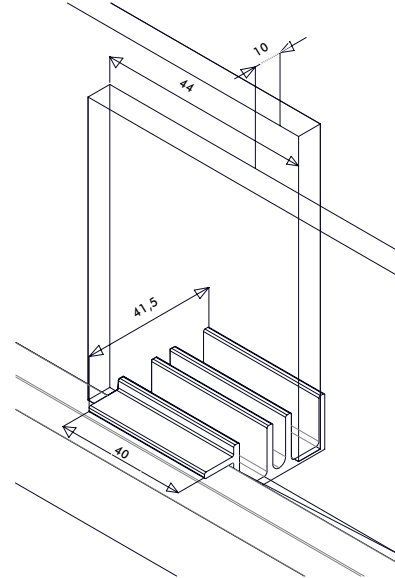

GUIADOR DOBLE

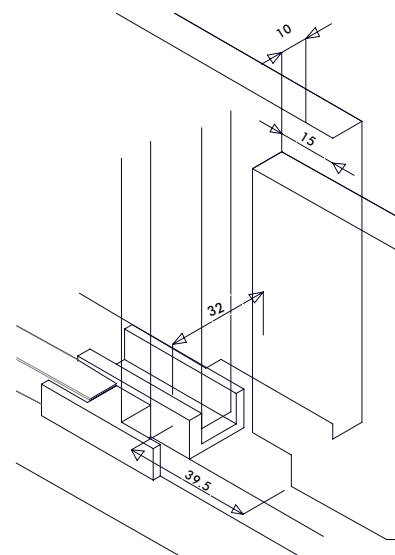

ACCESORIOS



Berlin Brillo

Código: 30HECR0013
Tirador en zamak
Acabado cromo brillo.
0.491 kg
PVP : 36 €



Berlin Mate

Código: 30HEPM0013
Tirador en zamak
Acabado plata mate.
0.491 kg
PVP : 40 €

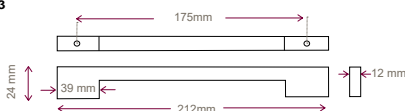

Berlin Negro

Código: 30HENM0013
Tirador en zamak
Acabado negro mate.
0.491 kg
PVP : 40 €

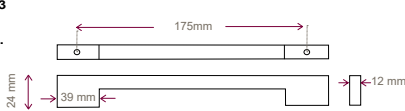

Berlin Cobre

Código: 30HECB0013
Tirador en zamak
Acabado cobre.
0.491 kg
PVP : 44 €



Roma Brillo

Código: 30HECR0012
Tirador en zamak
Acabado cromo brillo.
0.642 kg
PVP : 48 €

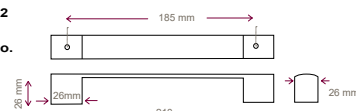

Roma Mate

Código: 30HEPM0012
Tirador en zamak
Acabado plata mate.
0.642 kg
PVP : 54 €

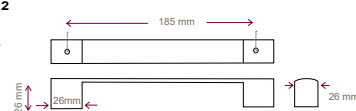

Roma Negro

Código: 30HENM0012
Tirador en zamak
Acabado negro mate.
0.642 kg
PVP : 54 €

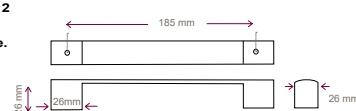

Roma Cobre

Código: 30HECB0012
Tirador en zamak
Acabado cobre.
0.642 kg
PVP : 58 €

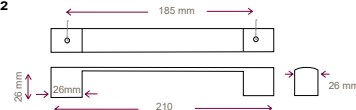

Londres Brillo

Código: 30HECR0017
Pomo cónico en zamak
Acabado cromo brillo.
0.193 kg
PVP : 32 €

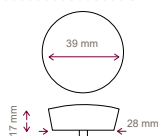

Londres Mate

Código: 30HEPM0098
Pomo cónico en zamak
Acabado plata mate.
0.193 kg
PVP : 36 €

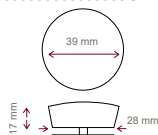

Londres Negro

Código: 30HENM0017
Pomo cónico en zamak
Acabado negro mate.
0.193 kg
PVP : 36 €

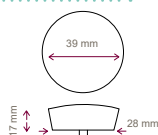

Londres Cobre

Código: 30HECB0017
Pomo cónico en zamak
Acabado cobre.
0.193 kg
PVP : 40 €

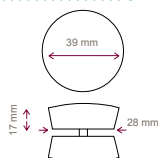

Paris Brillo

Código: 30HECR0019
Uñero en zamak
Acabado cromo brillo.
0.117 kg
PVP : 32 €

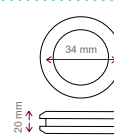

Paris Mate

Código: 30HEPM0019
Uñero en zamak
Acabado plata mate.
0.117 kg
PVP : 36 €

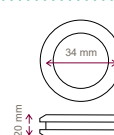

Paris Negro

Código: 30HENM0019
Uñero en zamak
Acabado negro mate.
0.117 kg
PVP : 36 €

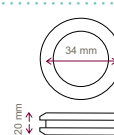

Paris Cobre

Código: 30HECB0019
Uñero en zamak
Acabado cobre.
0.117 kg
PVP : 40 €

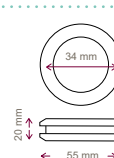

Brazo refuerzo cromo brillo

Código: 30HEPU0048
Barra de seguridad extensible 645 - 1000 mm
Acabado cromo brillo.
0.300 kg
PVP : 100 €

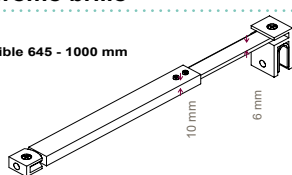

Brazo refuerzo negro mate

Código: 30HENE0048
Barra de seguridad extensible 645 - 1000 mm
Acabado mate negro.
0.300 kg
PVP : 100 €

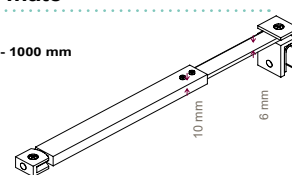

Bruselas Brillo

Código: 30HECR0024
Toallero en zamak
Acabado cromo brillo.
0.491 kg
PVP : 120 €

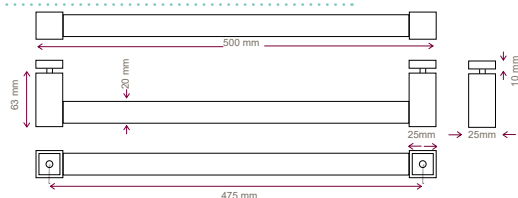

* Portes a cargo del cliente para pedidos inferiores a 150 €

CONSEJO DE SOPORTES



Lisboa Brillo

Código: 30HECR0064
Tirador en zamak
Acabado cromo brillo.
0.892 kg
PVP : 68 €

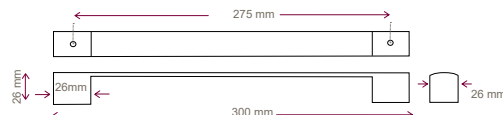

Lisboa Mate

Código: 30HEPM0064
Tirador en zamak
Acabado plata mate.
0.892 kg
PVP : 76 €

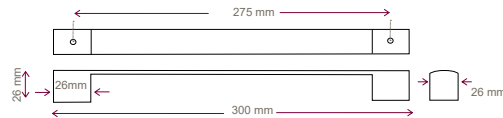

Lisboa Negro

Código: 30HENM0064
Tirador en zamak
Acabado negro mate.
0.892 kg
PVP : 76 €

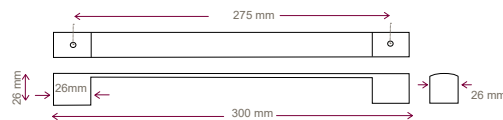



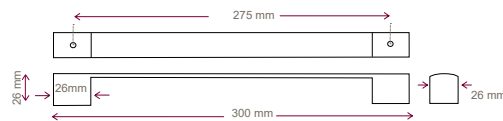

Lisboa Cobre

Código: 30HECB0064
Tirador en zamak
Acabado cobre
0.892 kg
PVP : 80 €



PERFILES ACERO INOX

* LONGITUD MAX 2MTS

Ref.	largo	€ / ml
 U de acero inox	20x11x1.2	15
 Rectangular de acero inox	30x10x1.5	24
 Rectangular de acero inox	20x10x1.5	20
 Rectangular de acero inox	10x12x1.5	18

PERFILES ALUMINIO

* LONGITUD MAX 2MTS

 Rectangular de aluminio brillo	20x10	12
 Rectangular de aluminio brillo	50X30	18
 Rectangular de aluminio brillo	60X40	20
 Cuadradillo de aluminio	40x40	16
 Cuadradillo de aluminio	20x20	14
 Ángulo aluminio	20x40	12
 Ángulo aluminio	40x40	14
 Pletina	20X3	10
 Pletina	50X2	14

Soporte longitudinal

Cuando la puerta de una mampara cierra contra un fijo, es aconsejable colocar un soporte longitudinal, por encima de la mampara, ya que este le confiere más estabilidad y seguridad al fijo.

La estabilidad del fijo es mayor cuando el punto de anclaje se encuentra más cerca del vértice.

Por ello, siempre es aconsejable poner este soporte, y con más motivo si el fijo es superior a 40 cm.

Este tipo de anclaje es el más seguro y estable, en el supuesto que se produzca un apoyo puntual ejercido por un posible resbaón en el interior de la ducha.

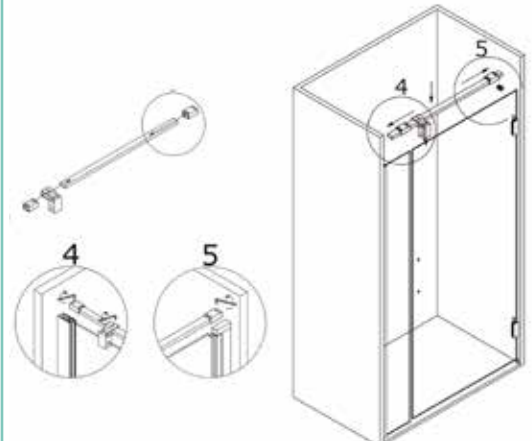

Soporte oblicuo

Este soporte se instala únicamente con vidrios menores de 40 cm. Con fijos superiores a esta medida no es aconsejable por producir mimbres al abrir o cerrar la puerta contigua.

También hay que tener en cuenta que este soporte se introduce hacia el interior de la mampara y puede llegar a invadir la zona del duchón. Solo se pondrá este soporte cuando no sea posible anclar la barra longitudinal a la pared o por expresa petición del cliente, asumiendo el riesgo del mimbres del fijo.

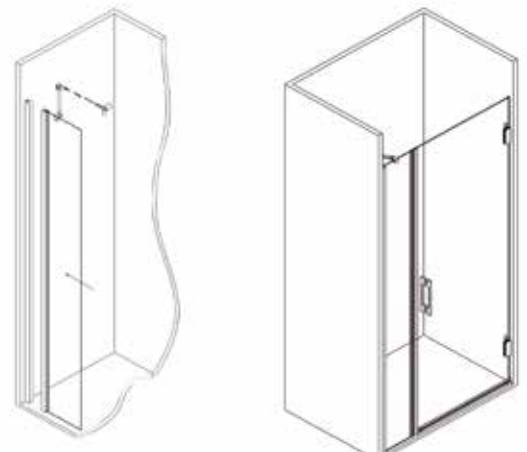

DECORADOS (SIMIL MATE)

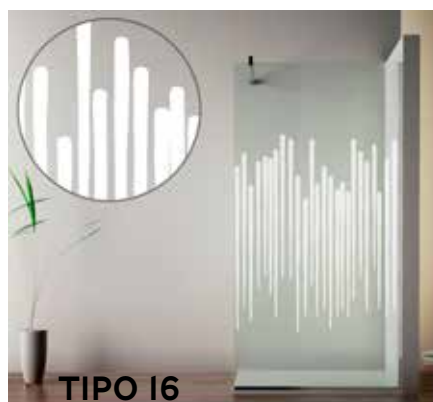

IMPRESIÓN DIGITAL (SELECCIONAR TIPO Y OPCIÓN)

OPCIÓN A

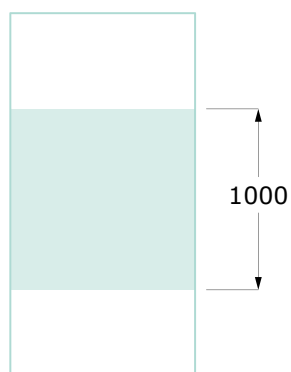

56 M/L

OPCIÓN B

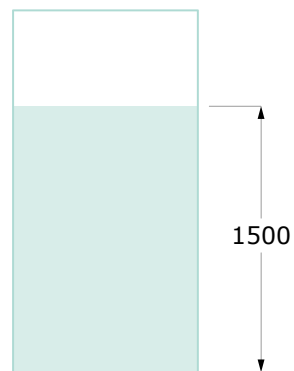

84 M/L

OPCIÓN C

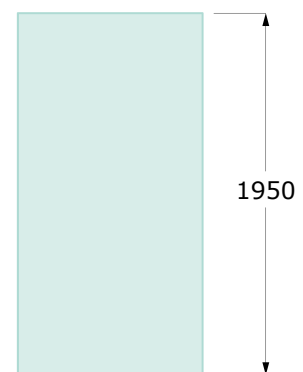

110 M/L

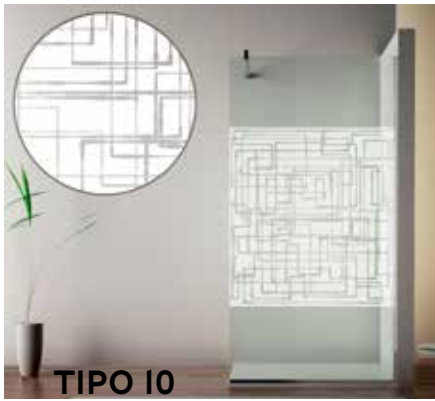

TIPOS DE VIDRIO

G 0

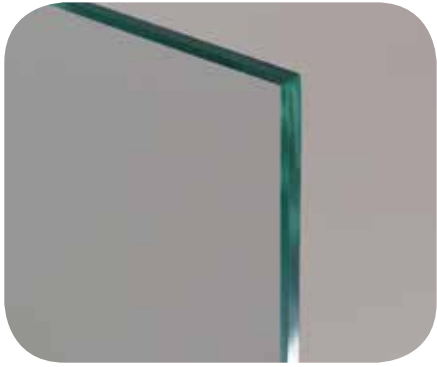

Transparente - Incoloro

G 1

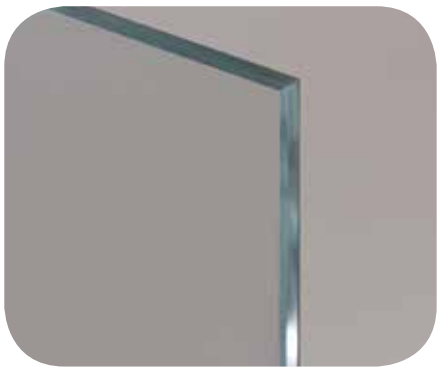

Extraclaro

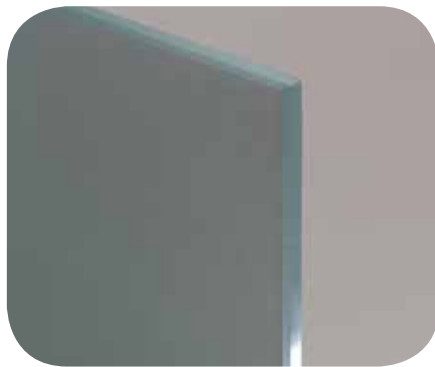

Mate - Ácido



Bronce



Gris



Azul

G 2



Negro



Espejo

Precio G2 corresponde solo a un vidrio por mampara.
Para añadir otro vidrio espejo, aumentar un 10% al precio G2.

SPAZIA ANTICAL

SPAZIA-Antical es un sistema de protección especial que aplicamos a la superficie del vidrio, formando una capa protectora que repele los líquidos y minimiza las incrustaciones de suciedad y cal. Esta aplicación es una adhesión química que se convierte en permanente sobre toda la superficie manteniéndose estable a los ciclos alternados de exposición de rayos UVA y condensación.

Spazia-Antical sella el poro del cristal evitando la absorción de contaminantes y polución, ayudando a prevenir el deterioro causado por las manchas y la corrosión. Como resultado reduce notablemente la frecuencia de limpieza del cristal y los costes de mantenimiento.

CONSEJOS DE CONSERVACIÓN

PARA LA CONSERVACIÓN DE CROMADOS Y HERRAJES, UTILICE SIEMPRE AGUA ABUNDANTE CON JABÓN NEUTRO

- No use productos con alcohol que puedan dañar el lacado y el anodizado del aluminio.
- Utilizar paños suaves al ser posible de algodón o esponjas no abrasivas.
- Nunca utilice amoníaco, disolventes o estropajos.

PARA LA CONSERVACIÓN DEL VIDRIO UTILICE PRODUCTOS NO ABRASIVOS, ACLARE CON AGUA Y SEQUE

- Enjuague con agua las partes en las que pueda quedar jabón, cuando termine.
- Sea prudente al agarrarse a las partes móviles de la mampara.
- Ventile su baño siempre que sea posible



TOMA DE MEDIDAS

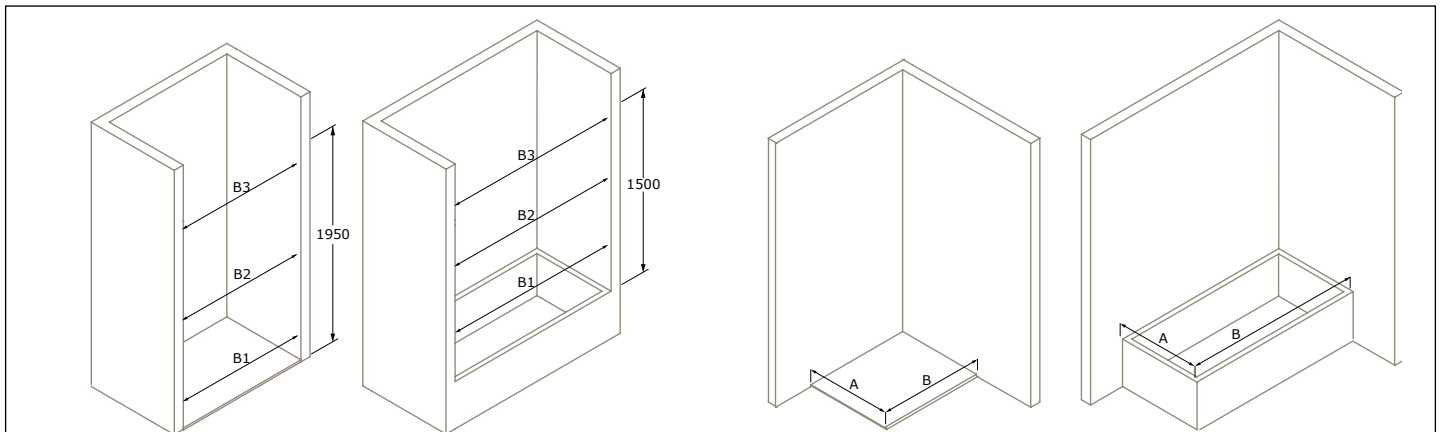

En duchas y bañeras frontales tomar 3 medidas: Inferior, Medio y Superior.

En duchas y bañeras en ángulo tomar las medidas desde la pared hasta el final del plato o bañera.

Indicar posibles obstáculos que impidan la correcta apertura de las puertas, ya sean armarios, sanitarios, radiadores, etc.

Tener en cuenta las alturas de los rociadores, huecos, ventanas o cenefas con relieves.

Para evitar posibles errores indicar la posición de la grifería y sentido de apertura de las puertas.

Es recomendable colocar la parte fija de la mampara en el lado de la grifería.

TIPO DE PLATO

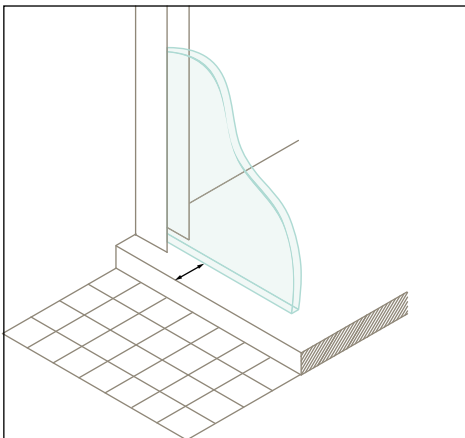

PLATOS EXTRAPLANOS

En los platos con cantos rectos, se recomienda colocar el fijo a 10mm del borde exterior. Cada serie tiene su medida exacta en el manual de montaje.

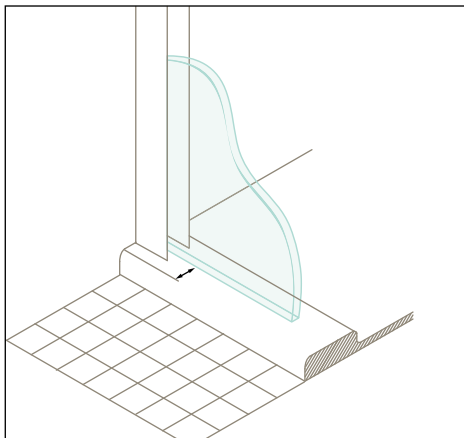

PLATOS CON CANTO REDONDEADO

En los platos con cantos redondeados, se recomienda colocar el fijo sobre la zona plana del plato. La posición depende de la curvatura de cada plato. Cada serie tiene su medida exacta en el manual de montaje.

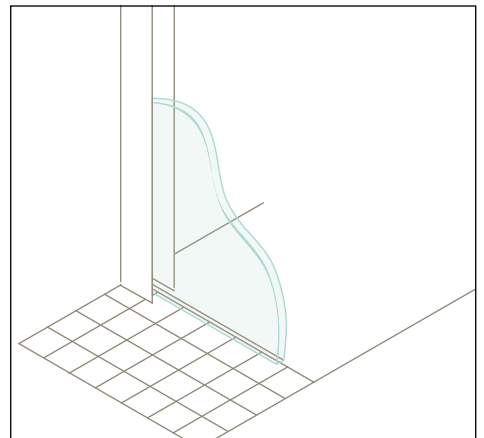

PLATOS ENRASADOS

En los platos enrasados a suelo, se recomienda colocar el fijo sobre la línea separadora entre Bronceado y plato. **IMPORTANTE** indicar este tipo de colocación al pedir la mampara.

CONDICIONES DE VENTA

CONDICIONES GENERALES

El cliente acepta que la legislación aplicable es la española y la jurisdicción competente es la de los Juzgados y Tribunales de Castellón, renunciando a cualquier otro fuero que pudiera corresponderle. Spazia Glass, S.L. se reserva el derecho a realizar los cambios que considere oportunos en los términos y condiciones establecidos. Cualquier notificación, requerimiento, o petición que hayan de efectuarse por las partes en relación con las presentes condiciones generales, deberán realizarse por escrito entre ambas. Si cualquier cláusula incluida en estas condiciones generales fuese declarada, total o parcialmente, nula o ineficaz, tal nulidad o ineficacia afectará tan sólo a dicha disposición. Desde el momento en el que el cliente realiza su pedido a la empresa Spazia Glass, S.L., se consideran aceptadas las condiciones descritas a continuación.

PRODUCTOS

Las fotografías y descripciones de los productos que aparecen en este catálogo deben entenderse únicamente a nivel informativo. Spazia Glass, se reserva el derecho a modificar parcial o totalmente sin previo aviso, los productos si así lo estimase necesario.

PRECIOS

Los precios están indicados en euros y no incluyen ningún tipo de impuestos. La presente tarifa anula toda las anteriores.

Spazia Glass, S.L. se reserva el derecho a modificar dichos precios sin previo aviso. En todo caso los precios válidos serán los indicados en la confirmación de cada pedido.

PEDIDOS

Los pedidos de los clientes sólo serán considerados como aceptados por Spazia Glass, cuando envíe confirmación por escrito de los mismos, y serán considerados pedido en firme y puestos en producción, cuando dicha confirmación sea devuelta firmada por el cliente, en señal de aceptación de todas las condiciones de la venta: precio, medidas, plazo de entrega,...

Ningún pedido en firme podrá ser modificado ni anulado. En caso de tener que anular o modificar un pedido, Spazia comunicará al cliente los gastos que puedan originarse por esta decisión.

PLAZOS DE ENTREGA

La estimación de los plazos de entrega es puramente orientativa y no supondrá, en ningún caso, motivo de anulación total o, parcial del pedido ni será motivo de reclamación a ningún efecto. En el supuesto en que el plazo de entrega fuese de vital importancia para el comprador, éste deberá comunicarlo expresamente, por escrito en el momento de formalizar el pedido, y éste deberá ser aceptado por Spazia Glass, S.L.

CONDICIONES DE PAGO

Hasta la concesión de la oportuna clasificación y riesgo, los primeros pedidos serán abonados mediante pago anticipado, una vez pasado este trámite, se podrá solicitar pago a 30 días, siempre que el informe financiero sea favorable. En cualquier caso las condiciones de pago serán las pactadas con cada cliente en el momento de su apertura de cuenta, y las que figuren en cada confirmación de pedido. Todo retraso en el pago de una factura superior a 10 días de la fecha de ven-

cimiento, será objeto de un recargo equivalente al triple de la tasa de interés legal vigente en el momento, más los gastos producidos por el impago, y los gastos de gestión generados para su recobro. Un retraso en el pago de cualquier vencimiento, motivará el automático vencimiento de todos los plazos que queden pendientes del cliente en cuestión. Spazia Glass se reserva el derecho, en caso de retraso en el pago de alguna factura, a bloquear el envío de pedidos terminados y a paralizar o anular los que estén en curso.

TRANSPORTE Y SEGURO

Salvo indicación en contra específicamente indicada en la confirmación de pedido, el transporte esta incluido en Europa para pedidos de importe superior a 600 Euros. La entrega de nuestra mercancía se efectuará exclusivamente en las instalaciones de nuestro cliente. En caso de que la mercancía sufriera daños ocasionados por el transporte, el cliente deberá notificar a Spazia Glass a la recepción del envío. Para ello aconsejamos inspeccionar el contenido del embalaje a la entrega de éste y en el caso de que haya alguna anomalía, se tendrá que enviar un parte de incidencia antes de las 24 horas siguientes a la recepción del pedido. La no comunicación de alguna incidencia por parte del comprador, exime a Spazia Glass de cualquier compromiso de sustitución. El cliente es el único responsable de la mercancía desde el mismo momento de su recepción.

DEVOLUCIÓN DE MERCANCIAS

Como norma general, Spazia Glass, S.L., no admite devoluciones. En caso excepcional de una devolución, ésta deberá ser debidamente solicitada y autorizada por escrito por Spazia Glass, y en las condiciones que puntualmente se acuerden para dicha devolución. En ningún caso se admitirá devolución de producto con acabados y medidas de difícil reasignación a otra venta. En caso de aceptación por parte de Spazia de una devolución, ésta conllevará para el comprador un cargo de un 40% del valor de la compra en concepto de gastos de manipulación, administración, embalaje, y la devolución del pedido deberá realizarse por el comprador a portes pagados.

GARANTIA

Todos nuestros productos están garantizados de acuerdo a la Normativa Europea vigente por un plazo de 24 meses desde la fecha de entrega. La garantía no cubre en ningún caso defectos provocados por un montaje incorrecto o efectuado por personal que carezca de los conocimientos y herramientas adecuados, así como el uso inadecuado o impropio de los productos, malos tratos, daños causados por la calidad del agua, utilización de productos de limpieza agresivos, y deterioros no imputables al producto. Nuestra garantía cubre única y exclusivamente la sustitución del producto con la exclusión de cualquier otra compensación, montaje o desplazamiento. Queda expresamente excluida de esta garantía cualquier rotura de vidrio templado. Como recomendación, antes de transportarse a grandes distancias nuestro producto constituido por material muy frágil, el comprador debe comprobar que las características, dimensiones, acabados y estado son correctos y coinciden plenamente con el pedido realizado. El cliente es el único responsable de la mercancía desde el mismo momento de su recepción.

SALES CONDITIONS

GENERAL CONDITIONS

The customer accepts that the Spanish legislation is the only applicable and the competent jurisdiction is that of the Court and Tribunals of Castellon, renouncing any other privilege of exemption that could correspond to him. Spazia Glass S.L. reserves the right to make changes that considers appropriate to the established terms and conditions. Any notification, request or petition made by the parties concerning the present general conditions shall be made in writing. Should any of the clauses of these Terms and Conditions be wholly or partially invalid, the validity of the remaining clauses or parts thereof shall not be affected. The placement of an order by a customer shall be deemed the unconditional and irrevocable agreement to these General Sales Conditions, and the waiver of the Buyer's own purchase terms and conditions or any other similar document.

PRODUCTS

Product photos and descriptions shown in this Catalog are informative only. Spazia Glass reserves the right to partially or totally modify the product specifications without prior notice if necessary according to design or production needs.

PRICES

Prices shown are in Euros and do not include any taxes, custom duties, or other charges. Current pricelist cancels all previous.

Spazia Glass, S.L. reserves the right to change prices without any prior notice.

In any case the valid prices shall be those shown in our order confirmation.

ORDERS

Customer orders will be considered accepted by Spazia Glass, S.L. once an order confirmation is issued, and will be firm order and put in production when a signed copy of this order confirmation is sent back to the factory as acceptance of all terms: prices, measures, finishings, delivery date... No firm order can be neither changed nor cancelled. In the case of a cancellation or modification of a firm order already in production, Spazia will inform to the customer the costs caused for this interruption.

DELIVERY TIME

Delivery time and date are non-binding inasmuch as nothing else has been agreed. No compensation will be granted to the customer in case of delay and an order cannot be canceled for this reason. In the case of orders with an special fixed delivery date the customer shall inform to SPAZIA GLASS, who will accept it or not by writing, in the order confirmation.

PAYMENT TERMS

Until the corresponding classification and credit risk have been granted, first orders will be paid in full in advance. Once the client has a credit risk assigned, payment will be made in full within 30 days from the date of the invoice.

In any case, payment terms will be agreed with every customer and shown in order confirmation. Immediately upon a delay of 10 days after the payment date agreed, we are entitled to demand default interest of three times the legal current interest at this moment and fees and expenses caused for this delay. nsible of goods after delivery.

CONDITIONS DE VENTE

If a payment is not received in full when due, all pending payments will be automatically turn to due date. In case of delay in payment, Spazia Glass, SL reserves the right to block and stop all pending orders.

TRANSPORT AND INSURANCE

Unless otherwise specified in the order confirmation, transport is included in Europe for orders over 600 Euros. Deliveries will be exclusively made in our clients warehouse or showroom. In case of damages caused by transport, client must notify by writing to SPAZIA GLASS at the goods reception.

For this we strongly suggest to inspect the goods at the receiving to mark in the delivery note any default seen in the packing. A notice has to be sent to SPAZIA GLASS within 24 hours after the goods delivery. The lack of notice in time exempts SPAZIA GLASS of any responsibility in transport damages. The client is the only responsible of goods after delivery.

GOODS RETURNS

No goods return will be accepted unless prior and specific approval in writing from SPAZIA GLASS. Exceptionnally when a return is accepted by SPAZIA GLASS, the buyer will return the product with packaging and user guides at its own expenses and unless otherwise specified, buyer will be charged by a 40% of product value as administration, packing and manipulation costs. In no case will be accepted any return of goods with special measures and finishings.

WARRANTY

All our products are guaranteed according to the European Law for a period of 24 months, after the delivery date.

This limited warranty does not cover any damage that results from improper installation, accident, abuse, abnormal mechanical or environmental conditions, or any unathorized disassembly, repair or modification, as well as damages caused by the water quality or improper cleaning products.

This limited warranty covers only repair or replacement of the product without any other compensation or expenses of assembling or travel. It is specifically excluded in this warranty any tempered glass breakage.

Before to transport glasses to a long distance, due to the fragility of the product, we strongly recommend to check all characteristics, measures and finishings to ensure that all of them are correct and fit the purchase order.

The client is the only responsible of goods after delivery.

CONDITIONS GÉNÉRALES

Le client accepte que les présentes conditions générales de vente sont soumises à la Loi Espagnole, et que seul sera compétent le Tribunal de Castellon pour connaître de tout litige ayant trait à la validité, l'interprétation ou l'exécution des présentes.

Spazia Glass, S.L. se réserve le droit de modifier les conditions. N'importe quel notification, requête ou demande entre les parts en ce qui concerne ces conditions générales de vente doit être effectuée par écrit. Si un ou plusieurs articles de ces conditions générales de vente sont déclarés nuls ou inefficaces, tel nullité ou inefficace concerne seulement à cet article.

Les présentes conditions générales de vente sont considérées acceptées par le client dès le moment de passer la commande.

PRODUITS

Les photos et descriptions des produits montrés dans le Catalogue sont donnés à titre indicatif. Spazia Glass, se réserve le droit de modifier les modèles sans avis préalable, pour les améliorer ou adapter au marché.

PRIX

Les prix sont stipulés hors taxes en euros. Le présent tarif annule tous les antérieures.

Spazia Glass, S.L. réserve le droit de modifier ces prix sans avis préalable. En tout cas, le prix du produit sera celui montré à la confirmation de la commande.

DÉLAI DE LIVRAISON

Les délais mentionnés dans nos offres de prix et accusés de réception de commande sont toujours indicatifs, étant subordonnés aux contraintes de production ainsi qu'à tous cas fortuits indépendants de notre volonté, tels que grèves, interruptions de trafic, etc...

En aucun cas, un retard ne peut donner lieu à pénalités, indemnités ou dommages-intérêts. Dans le cas que la date de livraison soit d'extrême importance pour le client, il doit le marquer au moment de passer la commande.

CONDITIONS DE PAIEMENT

Jusqu'au moment de la classification du risque client pour notre service financière, les premières commandes seront réglées en prépaiement. Une fois le client est classifié pour travailler à crédit, le règlement des factures en France s'effectue par traite acceptée et domicilié à 30 jours de la date de facture.

En tout cas, les conditions de paiement seront celles accordées avec chaque client au moment d'ouverture du compte-client, et celles écrites à la confirmation de commande.

Tout retard dans le paiement d'une facture supérieur à 10 jours au-delà de la date figurant sur celle-ci, fera l'objet de pénalités de retard d'un montant au moins équivalent à celui qui résulterait de l'application d'un taux égal à trois fois le taux d'intérêt légal. A défaut de paiement à l'une quelconque des échéances, les autres échéances deviendront immédiatement dues, même si elles ont donné lieu à des traites.

Spazia Glass, se réserve le droit, en cas de non paiement ou de retard de paiement, d'annuler

les commandes ou marchés en cours ou d'en suspendre l'exécution sans mise en demeure préalable.

TRANSPORT ET ASSURANCE

Sauf indication contraire dans la confirmation de commande, nos marchandises sont livrées fran co pour toute commande supérieure à 600 Euros. La livraison de nos marchandises est effectuée exclusivement dans les locaux du client.

Le destinataire doit vérifier l'état de la marchandise à réception en présence du transporteur qui ne peut s'y opposer et indiquer précisément les dégâts éventuels sur les documents de celui-ci avec confirmation sous 24 heures. En l'absence de réserve expressément prévue sur le bon de réception des marchandises, notre responsabilité ne pourra en aucun cas être engagée.

Le client est le seul responsable de la marchandise dès le moment de sa réception.

RETOUR DE MARCHANDISES

En général, Spazia Glass, S.L. n'accepte aucun retour de marchandise. Dans le cas exceptionnel d'un retour, celui doit être accepté par écrit par Spazia Glass, et avec les conditions que ponctuellement seront accordées pour chaque retour. Spazia Glass n'acceptera aucun retour de produit avec finitions et mesures de difficile re-attribution.

Dans le cas d'un retour accepté par Spazia Glass, le client paiera un 40% du valeur en concept de manipulation, administration, emballage, etc... et la marchandise sera retourné avec le transport payé.

GARANTIE

Tous nos produits sont garantis d'accord avec la Loi Européenne pour un période de 24 mois dès la date de livraison.

Notre garantie ne couvre pas les défauts et détériorations provoqués par l'usure naturelle des pièces, les intempéries, les dommages causés par la qualité de l'eau et les dommages qui pourraient être la conséquence d'un usage inapproprié ou d'un entretien défectueux.

Notre garantie reste strictement limitée au déclassement, ou éventuellement à la fourniture en remplacement pur et simple de la pièce défectueuse, à l'exclusion de tous frais et indemnités de quelque nature que ce soit. Les bris de verre trempé sont exclues de la garantie.

Spazia Glass suggère qu'avant de transporter notre produit à longue distance, et donné sa fragilité, l'acheteur doit vérifier que les caractéristiques, dimensions, finitions et état sont corrects et sont d'accord avec la commande originelle.

Le client est le seul responsable de la marchandise dès le moment de sa réception.

MAMPARA DE BAÑO

PROPUESTA DE PEDIDO

FECHA: _____

CLIENTE: _____

DIRECCIÓN: _____

TELF: _____ FAX: _____

Enviar a:
Fax: 9646 52 899
e-mail: pedidos@spazia.es

SELECCIONE EL TIPO DE DUCHA O BAÑERA

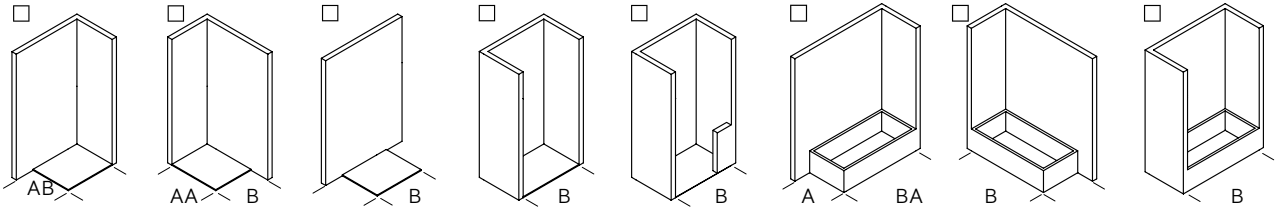

MAMPARA A MEDIDA

- SOLID
- SIDE
- MOON
- SUITE
- PASS
- DUNE
- FORUM
- NEXUS
- INFINITI
- ROLLING
- COMBI
- STAR
- HANDI
- FLEX
- NOVA
- OPEN
- QUADRO
- NATURE

MAMPARA STANDARD

- SOLID
- SIDE
- MOON
- STAR
- WALL

REF: _____

TIPO DE PLATO DONDE SE COLOCA LA MAMPARA

- PLATO ENRASADO
- PLATO ELEVADO

TIPO DE VIDRIOD

- TRANSPARENTE
- EXTRACLARO
- MATE-ACIDO
- GRIS
- BRONCE
- AZUL
- ESPEJO
- NEGRO

ECORADO

N:

IMPRESION

- OPCION A
- OPCION B
- OPCION C

ANTICAL

- SÍ
- NO

ESPESOR

- 6 mm
- 8 mm

MEDIDA A (en milímetros):

MEDIDA B (en milímetros):

ALTURA (en milímetros):

REF: _____

CROQUIS DE MAMPARA

PUERTAS DE PASO

PROPUESTA DE PEDIDO

FECHA: _____

CLIENTE: _____

DIRECCIÓN: _____

TELF: _____ FAX: _____

Enviar a:

Fax: 964 652 899

e-mail: pedidos@spazia.es

PUERTAS CORREDERAS

INDICAR MEDIDAS DE HUECO REAL

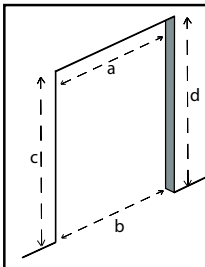

ANCHURA (en mm):
a: _____
b: _____

ALTURA (en mm):
c: _____
d: _____

SELECCIONE EL MODELO DE CORREDERA

- NEXUS TECHNICAL
 STYLE FRAME
 ROLLING INVISIBLE
 CASONETO
- REF: _____

SELECCIONE EL TIPO DE ANCLAJE

PARED TECHO OCULTO

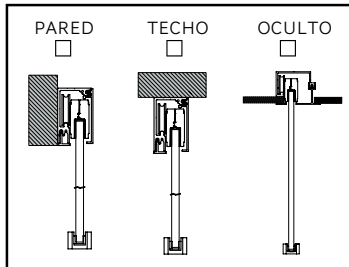

TIPO DE APERTURA

UÑERO TIRADOR

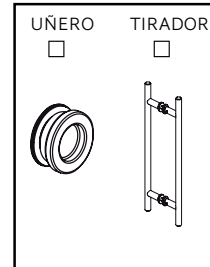

PUERTAS BATIENTES

INDICAR MEDIDAS DE HUECO REAL

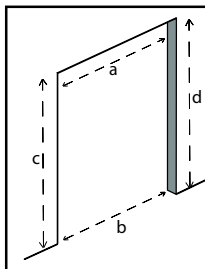

ANCHURA (en mm):
a: _____
b: _____

ALTURA (en mm):
c: _____
d: _____

SELECCIONE EL MODELO DE PUERTA

- SELECCIONE EL MODELO DE BATIENTE
- HIDRA
 PACK
 CLICK
- REF: _____

TIPO DE APERTURA

MANETA TIRADOR

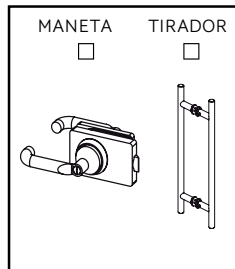

CROQUIS DE PUERTA :

TIPO DE VIDRIO

- TRANSPARENTE
 EXTRACLARO
 MATE-ACIDO
 GRIS
 BRONCE
 AZUL
 ESPEJO
 NEGRO

ESPESOR

- 8 mm
 10 mm



wellness spaces.
Pol. Ind. La Mezquita. Nave 402
Ap. Correos 92
12600 Vall de Uxó - Castellón
Tel. +34 964 652 898
Fax. +34 964 652 899
info@spazia.es www.spazia.es



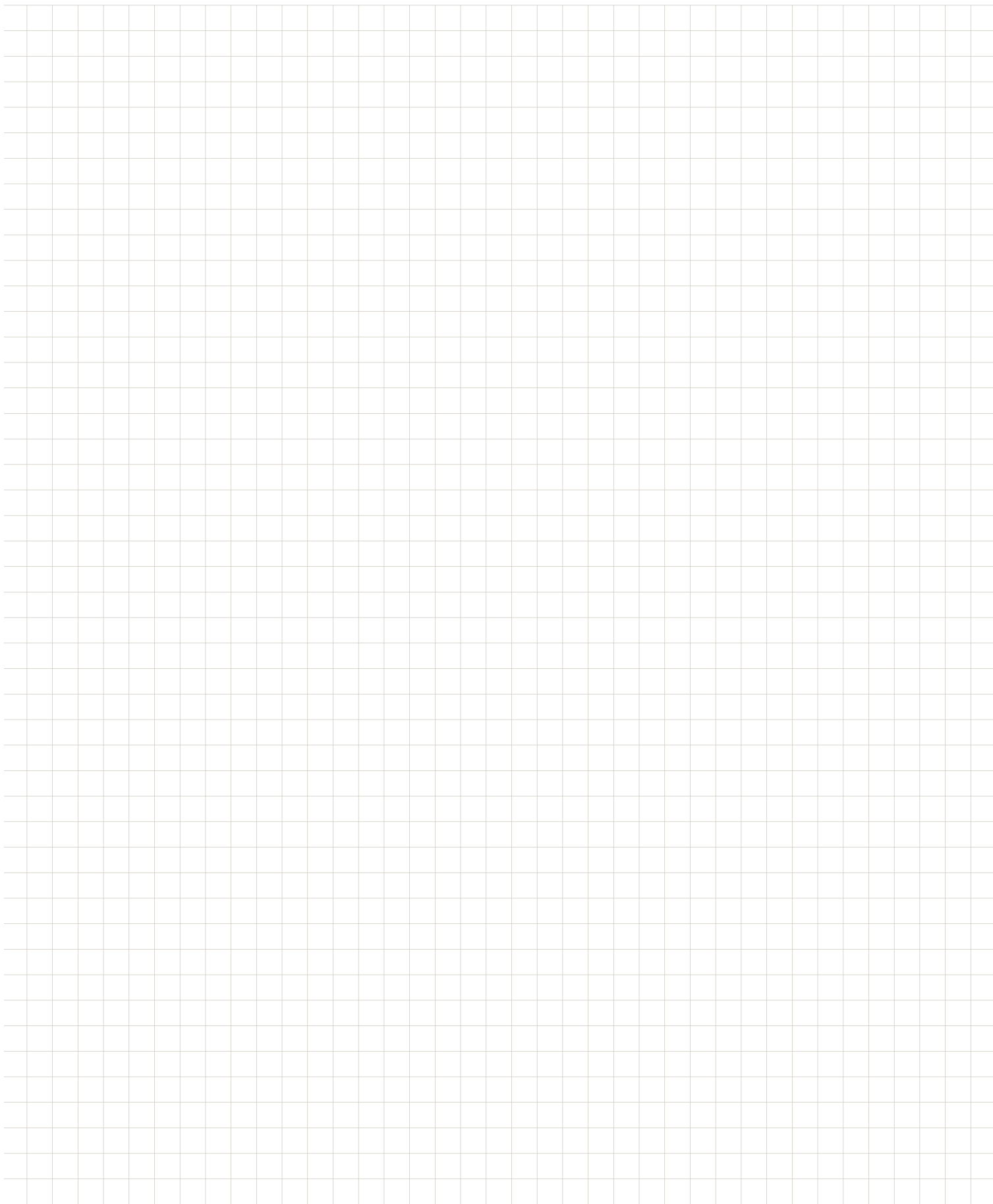

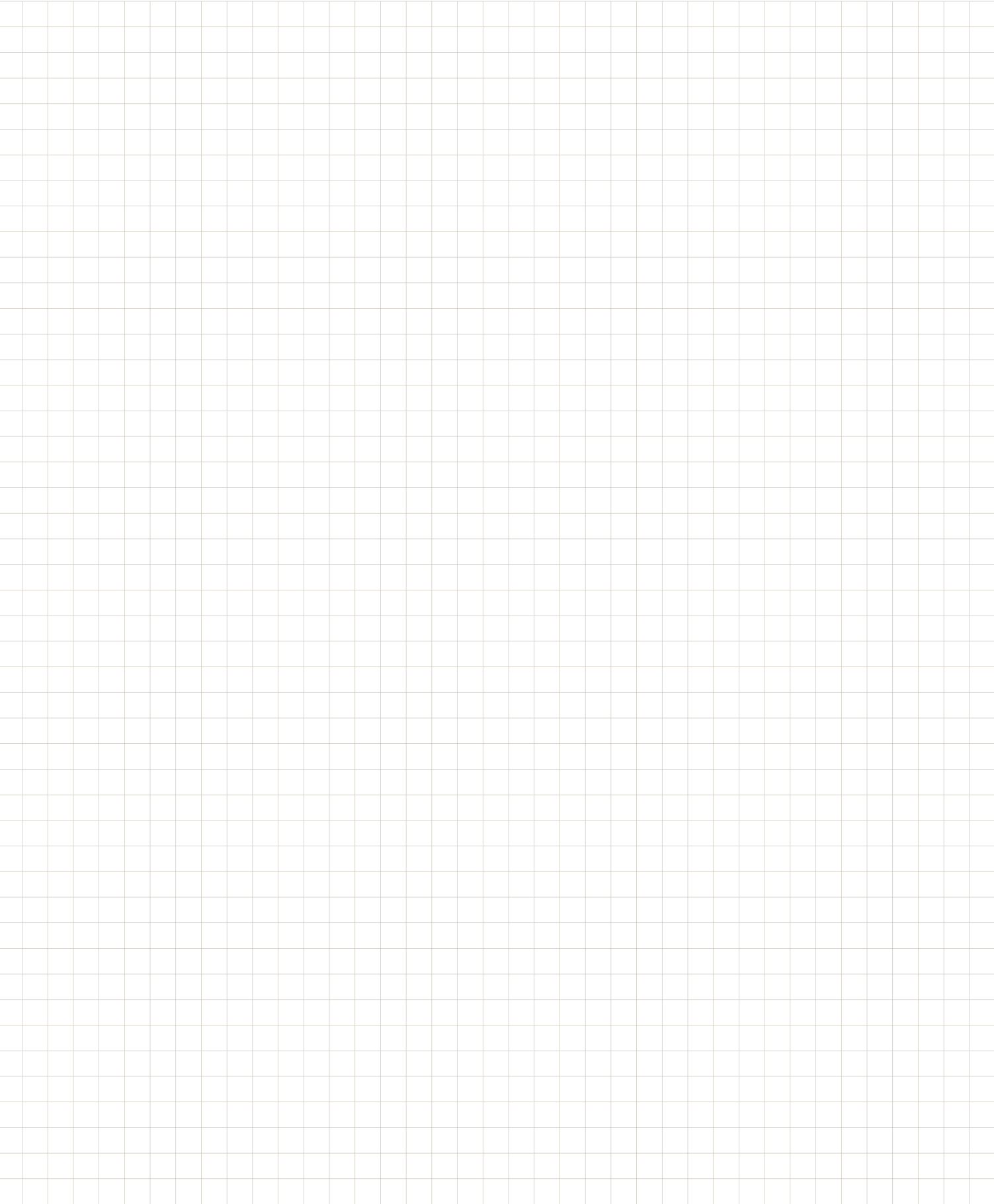

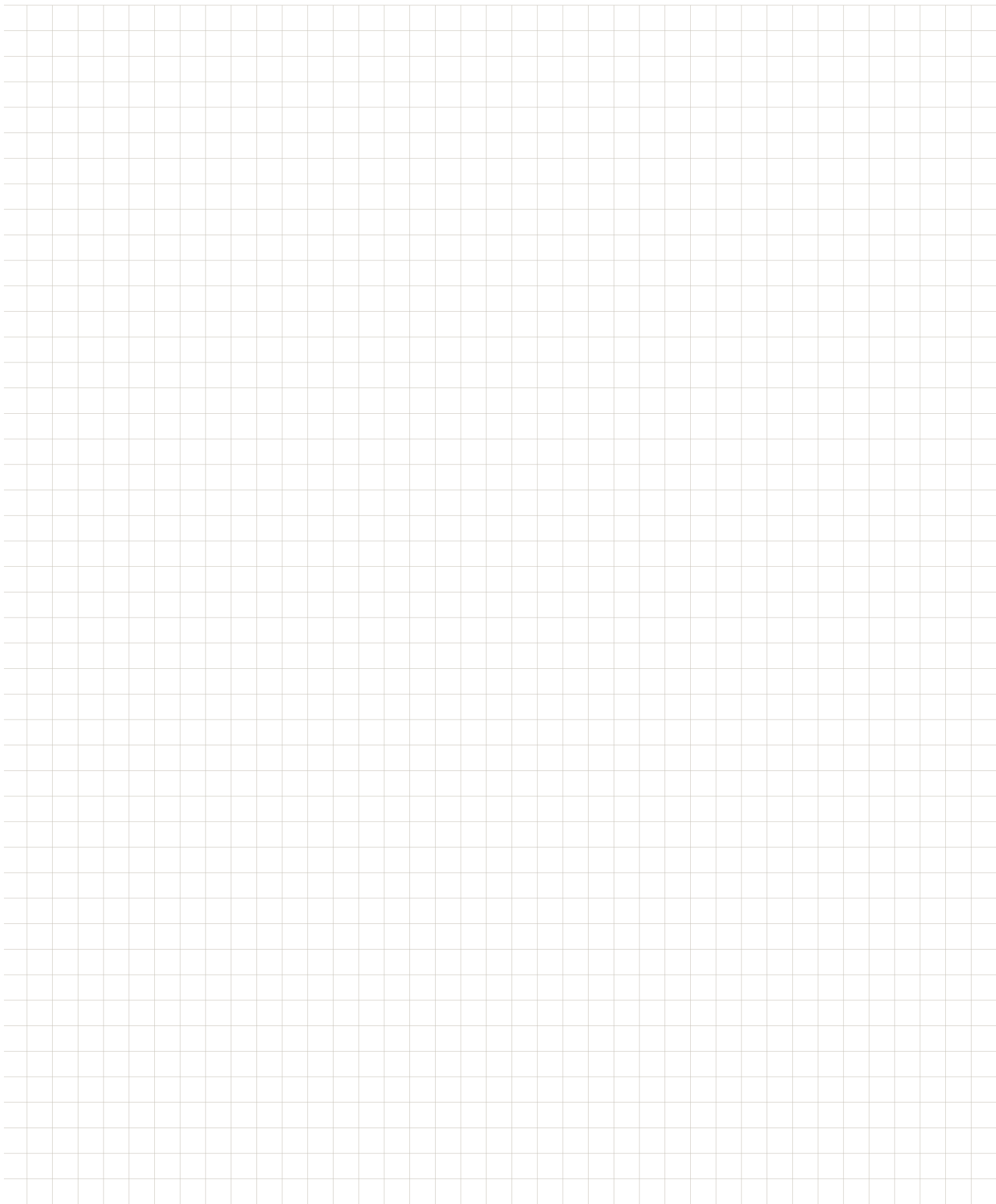

spazia

wellness spaces.

Pol. Ind. La Mezquita. Nave 308

Ap. Correos 92

12600 Vall de Uxó - Castellón

Tel. +34 964 652 898

Fax. +34 964 652 899

info@spazia.es www.spazia.es

CRÉDITOS / CREDITS / CRÉDITS

Maquetación
SPAZIA GLASS SL

Edición / Edition / Édition
SPAZIA GLASS SL

